

HP 83570A RF PLUG-IN

SERIAL NUMBERS

This manual applies directly to HP 83570A RF plug-in having serial number prefix 2643A.

For additional information about serial numbers, refer to INSTRUMENTS COVERED BY MANUAL in Section I.

©Copyright HEWLETT-PACKARD COMPANY 1987
1400 FOUNTAINGROVE PARKWAY, SANTA ROSA, CA 95401 U.S.A.

MANUAL PART NO. 83570-90018
Microfiche Part Number 83570-90019

Printed: APRIL 1987

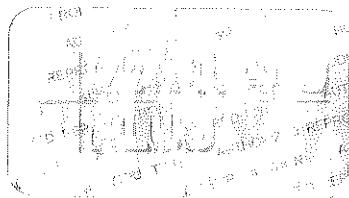

**HEWLETT
PACKARD**

CERTIFICATION

Hewlett-Packard Company certifies that this product met its published specifications at the time of shipment from the factory. Hewlett-Packard further certifies that its calibration measurements are traceable to the United States National Bureau of Standards, to the extent allowed by the Bureau's calibration facility, and to the calibration facilities of other International Standards Organization members.

WARRANTY

This Hewlett-Packard instrument product is warranted against defects in material and workmanship for a period of one year from date of delivery, or, in the case of certain major components listed in section six of this Operating and Service manual, for the specified period. During the warranty period, Hewlett-Packard Company will, at its option, either repair or replace products which prove to be defective.

For warranty service or repair, this product must be returned to a service facility designated by HP. Buyer shall prepay shipping charges to HP and HP shall pay shipping charges to return the product to Buyer. However, Buyer shall pay all shipping charges, duties, and taxes for products returned to HP from another country.

LIMITATION OF WARRANTY

The foregoing warranty shall not apply to defects resulting from improper or inadequate maintenance by Buyer, Buyer-supplied software or interfacing, unauthorized modification or misuse, operation outside of the environmental specifications for the product, or improper site preparation or maintenance.

NO OTHER WARRANTY IS EXPRESSED OR IMPLIED. HP SPECIFICALLY DISCLAIMS THE IMPLIED WARRANTIES OF MERCHANTABILITY AND FITNESS FOR A PARTICULAR PURPOSE.

EXCLUSIVE REMEDIES

THE REMEDIES PROVIDED HEREIN ARE BUYER'S SOLE AND EXCLUSIVE REMEDIES. HP SHALL NOT BE LIABLE FOR ANY DIRECT, INDIRECT, SPECIAL, INCIDENTAL, OR CONSEQUENTIAL DAMAGES, WHETHER BASED ON CONTRACT, TORT, OR ANY OTHER LEGAL THEORY.

ASSISTANCE

Product maintenance agreements and other customer assistance agreements are available for Hewlett-Packard products.

For any assistance, contact your nearest Hewlett-Packard Sales and Service Office. Addresses are provided at the back of this manual.

TABLE OF CONTENTS

HP 83570A RF Plug-In

Section I. GENERAL INFORMATION

Introduction	1-1
Specifications	1-1
Safety Considerations	1-4
Instruments Covered by this Manual	1-5
Product Description	1-6
Equipment Required But Not Supplied	1-6
Ordering Manual/Microfiche	1-6
Equipment Available	1-6
Recommended Test Equipment	1-7

Section II. INSTALLATION

Introduction	2-1
Initial Inspection	2-1
Preparation for Use	2-1
Storage and Shipment	2-3

Section III. OPERATION

Introduction	3-1
Operating Characteristics	3-3
Frequency Resolution	3-3
Front Panel Features	3-7
Rear Panel Features	3-9
Operating Instructions	3-11
RF Plug-in Control Switch	3-11
Operator's Checks	3-13
Internal Leveling	3-13
External Crystal Detector Leveling	3-13
External Power Meter Leveling	3-14
External FM	3-16
RF Power Control	3-16
HP-IB	3-17
Firmware Revision Number	3-17
Phase-Lock Operation	3-17
Operator's Maintenance	3-19
Plug-in Error Codes	3-19
Fuses	3-19
Blue Service Tags	3-19

Section IV. PERFORMANCE TESTS

Introduction	4-1
Equipment Required	4-1
Operation Verification	4-1
Test Records	4-1
Related Adjustments	4-2
Test Sequence	4-2
Calibration Cycle	4-2
4-1. Frequency Range and Accuracy Test	4-3
4-1A. Alternate Swept Frequency and Marker Accuracy Test	4-6

4-2. Output Amplitude Test	4-8
4-3. Frequency Stability Test	4-11
4-4. Residual FM Test	4-14
4-4A. Alternate Residual FM Test	4-16
4-5. Spurious Signal Test	4-18
4-6. External Frequency Modulation Test	4-20
4-7. Square-Wave On/Off Ratio and Symmetry Test	4-24

Section V. ADJUSTMENTS

Introduction	5-1
Safety Considerations	5-1
Equipment Required	5-2
5-1. V REF/Oscillator Bias Adjustment	5-5
5-2. -10V Reference On A6 YO Driver	5-7
5-3. A6 YO Driver Board DAC Calibration	5-9
5-4. Frequency Accuracy	5-13
5-5. Delay Compensation	5-17
5-6. ALC Adjustment	5-21
5-7. Internal Leveled Flatness	5-25
5-8. Power Calibration	5-29
5-9. ALC Gain Adjustment	5-31
5-10. Power Sweep	5-35
5-11. FM Driver	5-39

Section VI. REPLACEABLE PARTS

Introduction	6-1
Two Year Warranty and Restored Exchange Parts ..	6-1
Abbreviations	6-1
Replaceable Parts List	6-1
Illustrations	6-2
Ordering Information	6-2
Spare Parts Kit	6-2

Section VII. MANUAL BACKDATING CHANGES

Introduction	7-1
Manual Change Instructions	7-1

Section VIII. SERVICE

Introduction	8-1
Recommended Service Accessories	8-1
Service Aids	8-2
Troubleshooting	8-2
Self-Test	8-2
Hexadecimal	8-3
Error Codes	8-4
Operator-Initiated Tests	8-5
Direct Component Addressing	8-5
Types of Failures	8-8

Section VIII. Service (Cont'd)

Recommended Test Equipment	8-8	Troubleshooting Diagnostics	8-69
Repair	8-9	Digital Control, Block A	8-69
After-Service Safety Checks	8-11	Power Level Reference, Blocks C and H	8-70
Schematic Diagram Notes	8-11	Detector/Detector Selection Switch, Block B	8-71
Mnemonics	8-15	Detector Leg, Blocks E, F, and G	8-73
Replacing A9 YIG Oscillator, A6 YO Driver, A7 YO Bias, or A2 Doubler Assemblies	8-15	Modulator Leg, Blocks I and L	8-73
Overall Block Diagram Description	8-17	Modulator Driver (Part of A2A1) and RF Modulator (Part of A2 Microcircuit)	8-76
Introduction	8-17	No RF Power	8-77
Digital Control	8-17	Full Uneveled RF Power	8-78
Frequency Control	8-17	A4 Automatic Leveling Control (ALC)	
Power Control	8-18	Circuit Description	8-79
A1 Front Panel Troubleshooting	8-21	Introduction	8-79
Introduction	8-21	General Operation	8-79
Error Codes E050 and E051	8-21	Address Decoder and Control Latches, Block A	8-79
Digital Display	8-21	Detector Inputs and Selection Switches, Block B	8-79
Annunciators	8-22	Sample and Hold Drivers, Block K	8-80
Keyboard	8-23	Input Sample and Hold, Block E	8-80
Rotary Knob (Rotary Pulse Generator, RPG)	8-25	Power Meter Log Amplifier, Block F	8-82
Front Panel Disassembly	8-27	Log Amplifier, Block G	8-82
Procedure	8-27	Power Level Reference, Block C	
A1 Front Panel Circuit Description	8-29	Power Level Summing, Block H	8-82
Introduction	8-29	Error, Sample and Hold, Block I	8-83
Keyboard	8-29	Log Amplifier Selector, Block J	8-83
Display	8-29	Main ALC AMP, Block L	
Rotary Knob (Rotary Pulse Generator, RPG)	8-30	Uneveled Signal, Block M	8-83
A2 Doubler Circuit Troubleshooting	8-37	A5 FM Driver Troubleshooting	8-91
Introduction	8-37	Introduction	8-91
No RF Power	8-38	YIG Main Coil FM Driver and YIG FM Coil Driver Troubleshooting	8-91
Full Uneveled RF Power	8-39	FM Configuration Control Circuits Troubleshooting	8-92
A2 Doubler Circuit Description	8-41	Power Sweep/ALC Adjustments Troubleshooting	8-95
Introduction	8-41	A5 FM Driver Circuit Description	8-101
A2A2 Doubler Microcircuit	8-41	Introduction	8-101
A2AT1 Isolator	8-42	YIG Coil FM Driver, Block B and E	8-102
A2A1 Pulse Assembly	8-42	YIG FM Coil Driver, D, F, and H	8-102
A3 Digital Interface Troubleshooting	8-47	Address Decoder, Block A	8-104
Plug-in Self Test	8-48	Control Latches, Block C	8-104
No Error Code	8-50	ALC Flatness Adjustments, Block I	8-104
A3 Digital Interface Circuit Description	8-55	Power Sweep, Block H	8-105
Introduction	8-55	A6 YO Driver Troubleshooting	8-113
Sweep Oscillator Interface, Block A	8-55	Introduction	8-113
Address Decoder, Block B	8-55	General	8-113
ROM, Block B	8-55	Sweep Circuitry	8-113
200 kHz Clock, Block D	8-55	YO Drive Circuits	8-114
Interrupt Control/Configuration Switch, Block E	8-56	Interrupt Control, Block E	8-114
RF Plug-in Interface, Block F	8-56	Digital Control, Blocks A, C, and H	8-115
A4 ALC Troubleshooting	8-65	-10V REF, Block J	8-116
Introduction	8-65	CW Filter, Block K	8-116
Troubleshooting Symptoms	8-65	A6 YO Driver, Circuit Description	8-123
RPG/Power Display Failure	8-66	Introduction	8-123
Uneveled Led Is On	8-67	Tuning Voltage Buffer Amplifier, Block B	8-123
Power Flatness/Oscillations	8-67	Scaled Voltage Tune DAC, Block D	
Full Uneveled Power	8-67	Offset DAC, Block F	8-123
No Power	8-68	Input Data Latches, Block C	8-124
Power Sweep/Flatness	8-69		

Section VIII. SERVICE (Cont'd)

+20V Tracking Amplifier, Block G 8-124
Summing Amplifier, Block I 8-124
-10V Reference, Block J 8-125
Sweep Control/Interrupt Logic, Block E .. 8-125
Frequency Cal Switches/Output Data Buffers,
Block H 8-126
Supply Filtering, Block N 8-126
YO Coil Current Source, Block K
Yo Coil Current Driver, Q1 8-126
A7 Bias Troubleshooting 8-133
Introduction 8-133
Digital Control 8-133
V Ref 8-133
YIG Bias 8-134

Exponential Amplifier 8-134
Delay Compensation, Block D 8-134
Pulse Modulation Logic, Block F 8-134
A7 Bias Assembly, Circuit Description 8-135
Tuning Voltage Differential AMP, Block A . 8-135
Digital Control Switch, Block B 8-135
+8.0V REF Voltage Supply, Block C 8-135
Delay Compensation, Block D 8-135
Frequency Tracking Amplifier, Block E ... 8-136
Pulse Modulation Logic, Block F 8-136
Summing Amplifier, Block G 8-137
Exponential Amplifier, Block H 8-137
Unleveled Logic, Block I 8-137
YIG Bias, Block J 8-137

SAFETY CONSIDERATIONS

GENERAL

This product and related documentation must be reviewed for familiarization with safety markings and instructions before operation. This product has been designed and tested in accordance with international standards.

SAFETY SYMBOLS

Instruction manual symbol: the product will be marked with this symbol when it is necessary for the user to refer to the instruction manual (refer to Table of Contents).

Indicates hazardous voltages.

Indicates earth (ground) terminal.

WARNING

The WARNING sign denotes a hazard. It calls attention to a procedure, practice, or the like, which, if not correctly performed or adhered to, could result in personal injury. Do not proceed beyond a WARNING sign until the indicated conditions are fully understood and met.

CAUTION

The CAUTION sign denotes a hazard. It calls attention to an operating procedure, practice, or the like, which, if not correctly performed or adhered to, could result in damage to or destruction of part or all of the product. Do not proceed beyond a CAUTION sign until the indicated conditions are fully understood and met.

SAFETY EARTH GROUND

This is a Safety Class I product (provided with a protective earthing terminal). An uninterruptible safety earth ground must be provided from the main power source to the product input wiring terminals, power cord, or supplied power cord set. Whenever it is likely that the protection has been impaired, the product must be made inoperative and secured against any unintended operation.

BEFORE APPLYING POWER

Verify that the product is configured to match the available main power source per the input power configuration instructions provided in this manual.

If this product is to be energized via an auto-transformer make sure the common terminal is connected to the neutral (grounded side of the mains supply).

SERVICING

WARNING

Any servicing, adjustment, maintenance, or repair of this product must be performed only by qualified personnel.

Adjustments described in this manual may be performed with power supplied to the product while protective covers are removed. Energy available at many points may, if contacted, result in personal injury.

Capacitors inside this product may still be charged even when disconnected from their power source.

To avoid a fire hazard, only fuses with the required current rating and of the specified type (normal blow, time delay, etc.) are to be used for replacement.

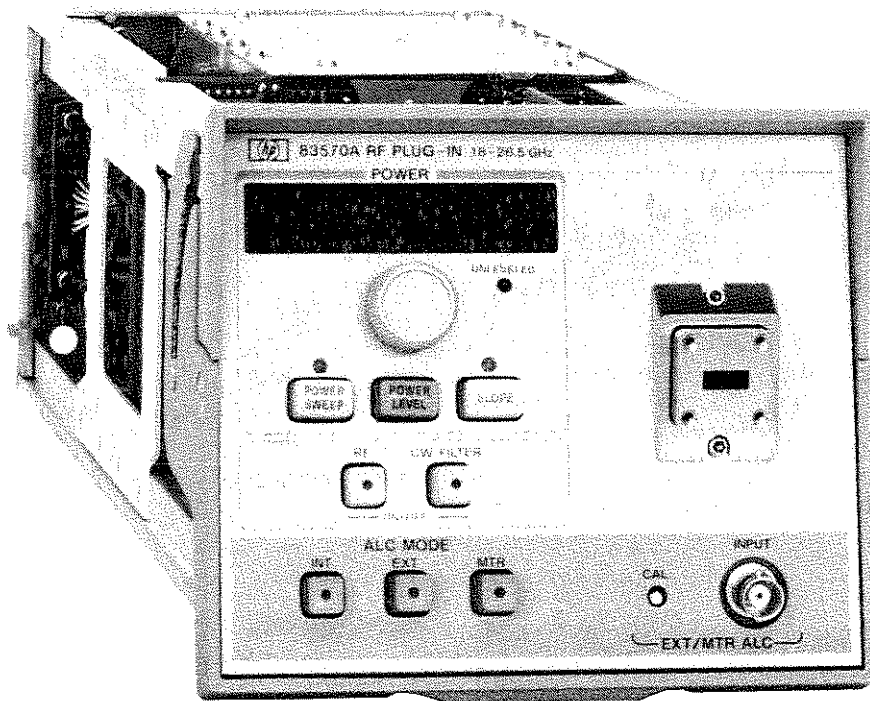

Figure 1-1. HP 83570A RF Plug-in

Section I. General Information

INTRODUCTION

This manual contains the information required to install, operate, test, adjust, and service the Hewlett-Packard 83570A RF plug-in. Figure 1-1 shows the HP 83570A. This manual is divided into eight major sections which provide the following information:

SECTION I, GENERAL INFORMATION. This section contains:

- A brief description of the instrument
- Safety considerations
- Specifications
- Supplemental characteristics
- Instrument identification
- Accessories available
- Recommended test equipment

SECTION II, INSTALLATION. This section contains:

- Initial inspection
- Preparation for use
- Storage
- Shipment

SECTION III, OPERATION. This section contains:

- Operating characteristics
- Front and rear panel features
- Operating instructions
- Operator's maintenance

SECTION IV, PERFORMANCE TESTS. This section contains procedures to verify HP 83570A published specifications.

SECTION V, ADJUSTMENTS. This section contains procedures to adjust the HP 83570A after repair.

SECTION VI, REPLACEABLE PARTS. This section contains part numbers of replaceable components as well as ordering information.

SECTION VII, MANUAL BACKDATING. This section contains information on earlier shipment configurations.

SECTION VIII, SERVICE. This section contains:

- Overall instrument block diagram
- Troubleshooting and repair procedures
- Information on each assembly within the instrument

SPECIFICATIONS

Listed in Table 1-1 are instrument specifications.

Specifications are the performance standards, or limits, against which the product may be tested. Table 1-2 lists supplemental performance characteristics. Supplemental performance characteristics are not specifications, but are typical characteristics included as additional information for the user.

Table 1-1. HP 83570A Specifications

FREQUENCY CHARACTERISTICS 1

Frequency Range 18.0 to 26.5 GHz

Frequency Accuracy (25° C)

CW Mode ±30 MHz
 All Sweep Modes (sweep ≥100 ms) ±55 MHz
 Frequency Markers ... ±55 MHz ±0.5% of sweep width
 (sweep ≥100 ms)

Stability (CW mode)

With 10% Line Voltage Change ±80 kHz
 With 10 dB Power Level Change ±1.0 MHz
 With 3:1 Load SWR ±500 kHz
 Residual FM (10 Hz to 10 kHz BW) <30 kHz peak

OUTPUT POWER 1

Maximum Leveled Output Power 2 (25° C) +10 dBm

Minimum Settable Power -1.0 dBm

Power Level Accuracy 3 (25° C) Internally Leveled ±1.8 dB

Calibrated Range 10 dB

Power Variation

Internally Leveled ±1.4 dB
 Externally Leveled
 Negative Crystal Detector 4 ±0.1 dB
 Power Meter 5 ±0.1 dB

Residual AM in 100 kHz BW (in dB below carrier and at specified maximum leveled power) ≥50 dB

Spurious Signals (at specified maximum leveled power)

Harmonics related (in dB below carrier) ≥25 dB
 Non-harmonics (in dB below carrier) ≥50 dB

Output VSWR (internally leveled) ≤2.5

Power Sweep 6

Calibrated Range ≥11 dB

MODULATION CHARACTERISTICS

External AM

Maximum Input 15V

Internal AM

Selectable (by internal jumper in HP 8350) to 1 kHz or 27.8 kHz squarewave modulation. The 27.8 kHz modulation allows operation with the Scalar Network Analyzers.

On/Off Ratio ≥25 dB
 (below specified maximum leveled power)

Symmetry 40/60

External FM

Maximum deviations for modulation frequencies:

	Cross Over Coupled (MHz)	Direct Coupled (MHz)
DC to 100 Hz	±75	±12
100 Hz to 1 MHz	±7	±7
1 MHz to 2 MHz	±5	±5
2 MHz to 10 MHz	±1.0	±1.0

Frequency Response (DC to 2 MHz) ±3 dB

GENERAL SPECIFICATIONS 1

Minimum Sweep Time (over full band) 10 ms

RF Output Connector Type WR42 waveguide

1. Unless otherwise noted, all specifications are at the RF OUTPUT connector and at 0° to 55°C.
2. For temperatures greater than 25°C, maximum leveled output power typically degrades 0.1 dB/°C.
3. For temperatures greater than 25°C, power level accuracy, power typically degrades 0.02 dB/°C.
4. Excludes coupler and detector variation. Crystal detector output should be between -10 mV and -200 mV at specified maximum leveled power.
5. Use the HP 432A/B/C, HP 436A, or HP 438A power meters. Both the HP 436A and 438A must be used on the top three (least sensitive ranges. However the HP 438A may also be used on the fourth range by programming the response of the power meter's filter as follows: Set the HP 438A to range two and press [MANFILTER] [1] [ENTER]. See the HP 438A Operating and Service Manual for further instructions. Sweep time ≥50 seconds.
6. Power sweep and slope compensation total must not exceed 10 dB.

Table 1-2. HP 83570A Supplemental Specifications

NOTE

Values in this table are not specifications, but are typical characteristics included for user information.

FREQUENCY CHARACTERISTICS¹

Frequency Accuracy (25°C)

CW Mode, typically	
18 to 26.5 GHz	± 20 MHz
Manual Sweep	
18 to 26.5 GHz	< ± 100 MHz
Internal Sweep Mode	± 100 MHz
(sweep time 10 ms to 100 ms)	
Sweep Mode Linearity	
18 to 26.5 GHz	± 15 MHz

Stability (CW Mode)

With Temperature	± 800 kHz/°C
With Time	± 400 kHz
(in a 10 minute period after one hour warmup at the same frequency setting)	

OUTPUT CHARACTERISTICS

Output Power¹

Resolution (displayed)	0.1 dB
Remote Programming (settable), typically	± 0.01 dB
Stability with Temperature	± 0.1 dB/°C
(at maximum specified leveled power)	

Spurious Signals (in dB below carrier)

Harmonics, typically	≥ 30 dB
(at specified maximum leveled power)	
Non-harmonics, typically	≥ 50 dB
(at specified maximum leveled power)	

Impedance	50 ohms
Source VSWR, unleveled, typically	< 2.5

Power Sweep

Accuracy (including linearity), typically	± 1.5 dB
Resolution (displayed)	0.1 dB

Slope Compensation

Linearity, typically	< 0.2 dB
Calibrated Range	up to 5 dB/GHz
	up to 11 dB for full sweep range
Resolution (displayed)	0.01 dB/GHz

MODULATION CHARACTERISTICS

External AM

Frequency Response, typically	100 kHz
Input Impedance, approximately	10k ohm
Range of Amplitude Control, typically	11 dB
Sensitivity, typically	1 dB/V

External FM

Sensitivity (switch selectable)	
FM mode, typically	-20 MHz/V
Phase Lock Mode, typically	-6 MHz/V
Input Impedance	2000 ohms, nominal

GENERAL CHARACTERISTICS

Weight	Net 4.5 kg (10 lb), Shipping 7.7 kg (17 lb)
--------	---

1. Unless otherwise noted, all characteristics are at the RF OUTPUT connector and at 0° to 55°C.

SAFETY CONSIDERATIONS

This product has been manufactured and tested in accordance with international safety standards. Before operation, examine the product for safety related placards and labels; review the SAFETY CONSIDERATIONS information page which immediately precedes this section.

Manufacturer's Declaration

NOTE

This is to certify that this product meets the radio frequency interference requirements of Directive FTZ 1046/1984. The German Bundespost has been notified that this equipment was put into circulation and has been granted the right to check the product type for compliance with these requirements.

Note: If test and measurement equipment is operated with unshielded cables and/or used for measurements on open set-ups, the user must insure that under these operating conditions, the radio frequency interference limits are met at the border of his premises.

Model HP 83570A

NOTE

Hiermit wird bescheinigt, dass dieses Gerät/System in Übereinstimmung mit den Bestimmungen von Postverfügung 1046/84 funkentstört ist.

Der Deutschen Bundespost wurde das Inverkehrbringen dieses Gerätes/Systems angezeigt und die Berechtigung zur Überprüfung der Serie auf Einhaltung der Bestimmungen eingeräumt.

Zusatzinformation für Mess- und Testgeräte:

Werden Mess- und Testgeräte mit ungeschirmten Kabeln und/oder in offenen Messaufbauten verwendet, so ist vom Betreiber sicherzustellen, dass die Funk-Entstörbestimmungen unter Betriebsbedingungen an seiner Grundstücksgrenze eingehalten werden.

Safety Symbols

WARNING

This indicates a personal hazard. **WARNING** calls attention to a procedure, practice, etc., that, if not performed correctly, can cause personal injury. Do not continue past a **WARNING** until you fully understand and meet the stated conditions.

CAUTION

This indicates a mechanical or electrical hazard. **CAUTION** calls attention to an operating procedure, practice, etc., that, if not correctly performed or adhered to, can cause damage to (or destruction of) part or all of the instrument. Do not continue past a **CAUTION** until you fully understand and meet the stated conditions.

INSTRUMENTS COVERED BY THIS MANUAL

A serial number plate is attached to the plug-in's rear panel. A typical serial plate is shown in Figure 1-2, below. Note that the number is in two parts. The first four numbers with a letter are the serial number prefix. This manual applies to instruments having the same serial number prefix as shown on the title page under **SERIAL NUMBER**. The last five numbers form the numerical suffix that is unique to each plug-in.

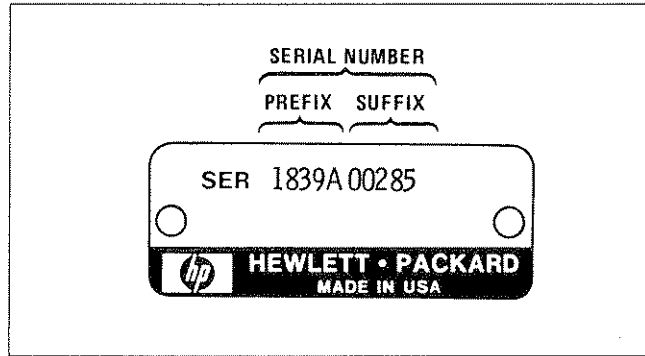

Figure 1-2. Typical Serial Number Label

A plug-in manufactured after the printing of this manual may have a serial prefix that is not listed on the title page. An unlisted serial prefix indicates that the plug-in is different from those documented in this manual. In such cases, the manual is supplied with a Manual Change Supplement that documents the differences.

The Manual Change Supplement also corrects errors in the manual. To keep your manual as current as possible, Hewlett-Packard recommends that you periodically request the latest Manual Change Supplement. Copies of the Manual Change Supplement are available from any HP Sales Office.

For information concerning a serial number prefix that is not listed on the title page or in the Manual Changes Supplement, contact your nearest Hewlett-Packard Sales and Service office. A list of these offices is shown at the end of this volume.

PRODUCT DESCRIPTION

The HP 83570A is an RF plug-in which has been designed for use with the HP 8350 Sweep Oscillators. The HP 83570A covers the frequency range of 18 to 26.5 GHz in one band and has a maximum leveled power output of +10 dBm.

EQUIPMENT REQUIRED BUT NOT SUPPLIED

To have a complete operating sweep oscillator the HP 83570A RF plug-in must be installed in a HP 8350 sweep oscillator. Refer to Section II, Installation, for details on plug-in installation.

ORDERING MANUAL/MICROFICHE

On the title page of this manual is a manual part number and a microfiche part number. Both can be used to order extra copies of this manual.

Microfiche are 10 X 15 cm (4 X 6 in) microfilm transparencies. Each microfiche contains reduced photocopies of the manual pages. Also included in the microfiche package is the latest manual changes supplement.

The manual part number also appears on the back cover, in the lower left hand corner.

EQUIPMENT AVAILABLE

Service Accessories

A service accessory kit is available to facilitate servicing the HP 83570A and the HP 8350. Table 1-3 shows what is included in the service accessory kit, as well as other available accessories. To obtain a service accessory kit, order HP Part Number 08350-60020, CD0.

Power Meters and Crystal Detectors

The RF output of the HP 83570A can be externally leveled using the HP 432A/B/C, 436A, or 438A power meters or negative polarity output crystal detectors.

HP 8756A/8757A Scalar Network Analyzers

The HP 8350/83570A combination is compatible with the HP 8756A and 8757A scalar network analyzers.

HP 8510A

The HP 8350/83570A combination is compatible with the HP 8510A vector network analyzer.

HP-IB Controllers

To use the HP-IB capabilities of the HP 8350 and HP 83570A, a computing controller, such as a Hewlett Packard 80 series, 200 series or HP 1000 computer, is required.

RECOMMENDED TEST EQUIPMENT

Table 1-4 lists the equipment required to test and adjust the HP 83570A. Other equipment may be substituted if it meets or exceeds the indicated critical specifications.

Table 1-3. Service Accessories Available

Name	HP Part Number	Description
44-pin printed circuit board extender	08350-60031*	Extends printed circuit boards
RF Plug-in extender cables	08350-60034* 08350-60035*	Extends RF Plug-in Interface connector (P2) Extends RF Plug-in Power Supply Interface connector (P1)
Adjustment tool	8830-0024	Fits miniature adjustment slot on potentiometers
Wrenches	08555-20097 8710-0946	5/16" slotted box/open end 15/64" open end
Service cables	8120-1578 83525-60019	18" Coax with SMA (m) connector on each end 10" Coax with SMB snap on (f) and SMA (m)
Adapters	1250-07777 1250-0082 1250-1404 1250-1158 1250-0674 1250-0675 1250-0069	Type-N (f) to BNC (m) Type-N (m) to BNC (m) Type-N (f) to SMA (f) SMA (f) to SMA (f) SMA (f) to SMB (m) SMA (f) to SMC (m) SMB snap on (m) to SMB snap on (m)
Hex Balldriver	8710-0523*	Removes front panel hold down plate hex screws in HP 8350.
IC test clip	1400-0979* 1400-0979*	16-pin IC test clip 20-pin IC test clip
*These items are included in a Service Accessories Kit, HP Part No. 08350-60020 (2 board extenders are included in this kit).		

Table 1-4. Recommended Test Equipment (1 of 2)

Instrument	Critical Specifications	Recommended Model	Use*
Sweep Oscillator	No substitute	HP 8350	P, A, T
Digital Voltmeter (DVM)	Range: -50V to +50V Accuracy: $\pm 0.01\%$ Input Impedance: $\geq 10M$ Ohms	HP 3456A	A, T
Oscilloscope	Dual Channel Bandwidth: DC to 100 MHz Vertical Sensitivity: ≤ 5 m V/DIV Horizontal Sweep Rate: $\leq 0.1\mu S/DIV$ External Sweep Capability	HP 1741A	P, A, T
Oscilloscope Probe	1:1 General Purpose Probe	HP 10009B	A
Frequency Counter	Frequency Range: 0.01 to 20.0 GHz Input Impedance: 50 Ohms Resolution: ≤ 1 Mhz	HP 5343A	P, A
Spectrum Analyzer	Frequency Range: 0.01 to 20.0 GHz Residual FM: < 100 Hz	HP 8565A or HP 8566A	P, A, T
Swept Amplitude Analyzer	Capable of Transmission Measurements Power Resolution: ≤ 0.25 dB	HP 8757A	P, A
Detector	Compatible with Swept Amplitude Analyzer Frequency Range: 18.0 to 26.5 GHz Power Range: -20 to +10 dBm	HP 85025B	P, A
Frequency Meter	Frequency Accuracy: $\leq 0.17\%$ Calibration Increments: ≤ 2 MHz Frequency Range: 0.96 to 40.0 GHz 4.0 to 12.4 GHz 12.4 to 18 GHz	HP 536A HP 537A HP P532A	A A A
Function Generator	Frequency Range: 0.1 Hz to 10 MHz Sinewave and squarewave output Output Level: 10Vp-p into 50 ohms Output Level Flatness: $\leq \pm 3\%$ from 10 Mz to 100 kHz $\leq \pm 10\%$ from 100 kHz to 10 MHz	HP 3325A	P, A, T
Power Meter ¹	Power Range: -20 to +10 dBm (no substitute when used for external power meter leveling)	HP 436A	P, A
Adaptor	Waveguide to 3.5 (f)	HP K281C	A

1. NOTE: The HP 436 Power Meter or a negative polarity output crystal detector can be used to externally level the HP 83570A's RF output. The HP 436 must be used on the three least sensitive ranges.

Table 1-4. Recommended Test Equipment (2 of 2)

Instrument	Critical Specifications	Recommended Model	Use*			
Adaptors	2.5 (m) to N (f) 3.5 (m) to 3.5 (m) N (f) to BNC (f)	1250-1750 1250-1748 1250-1536	P P P			
BNC Tee	BNC Tee (m) (f) (f)	1250-0781	P			
Power Sensor	Frequency Range 0.01 to 20.0 GHz	HP 8485A	P, A			
Crystal Detector**	Frequency Response: 18.0 to 26.5 GHz Maximum Input Power: 100 mW	HP 8473C HP K422A	P, A P, A			
Attenuator**	Frequency Range: 18.0 to 26.5 GHz Maximum Input Power: +10 dBm Attenuation: 10 dB \pm 1.0 dB	HP 8493C Option 010	P, A			
Power Splitter **	Frequency Range: 0.01 to 20.0 GHz Maximum Input Power: \geq +20 dBm	HP 11667B	P, A			
Directional Coupler	Frequency Range: 18.0 to 26.5 GHz Nominal Coupling: \geq 10 dB Maximum Coupling Variation: $\leq \pm$ 0.5 dB Minimum Directivity: \leq 32 dB	HP 752C	P, A			
Directional Coupler	Frequency Range: 18.0 to 26.5 GHz Nominal Coupling: \geq 16 dB Maximum Coupling Variation: \pm 1 dB Minimum Directivity: 26 dB	HP Part No. 0955-0125	P			
RMS Voltmeter	dB Range: -20 to -70 dBm (0 dBm = 1 mV into 600 ohms) Frequency Range: 10 Hz to 10 MHz Accuracy: \pm 5% of full scale	HP 3400A	P			
Adjustable Short	Frequency Range: 18.0 to 26.5 GHz	HP K920B	P			
DC Power Supply	DC Output: 0 to 25.0 Vdc 0 to 0.4 amps	HP K914B	A			
50 Ohm Termination	Type-N 50 \pm 0.5 ohms	HP 10100C	P			
Delay Line Discriminator	Refer to Figure 1-3.		P, A			
PC Board Extender	44-pin, extends printed circuit boards	HP Part No. 08350-60031	A, T			
<p>* P = Performance Test; A = Adjustments; T = Troubleshooting</p> <p>** For testing of frequencies of \leq 18 GHz, the following equipment may be substituted:</p> <table style="width: 100%; border: none;"> <tr> <td style="text-align: center; vertical-align: top;"> <p>ATTENUATORS</p> <p>20 dB HP 8419B Option 020 10 dB HP 8419B Option 010 6 dB HP 8491B Option 006 3 dB 8491B Option 003</p> </td> <td style="text-align: center; vertical-align: top;"> <p>POWER SPLITTER</p> <p>HP 11667A</p> </td> <td style="text-align: center; vertical-align: top;"> <p>CRYSTAL DETECTOR</p> <p>HP 8470B</p> </td> </tr> </table>				<p>ATTENUATORS</p> <p>20 dB HP 8419B Option 020 10 dB HP 8419B Option 010 6 dB HP 8491B Option 006 3 dB 8491B Option 003</p>	<p>POWER SPLITTER</p> <p>HP 11667A</p>	<p>CRYSTAL DETECTOR</p> <p>HP 8470B</p>
<p>ATTENUATORS</p> <p>20 dB HP 8419B Option 020 10 dB HP 8419B Option 010 6 dB HP 8491B Option 006 3 dB 8491B Option 003</p>	<p>POWER SPLITTER</p> <p>HP 11667A</p>	<p>CRYSTAL DETECTOR</p> <p>HP 8470B</p>				

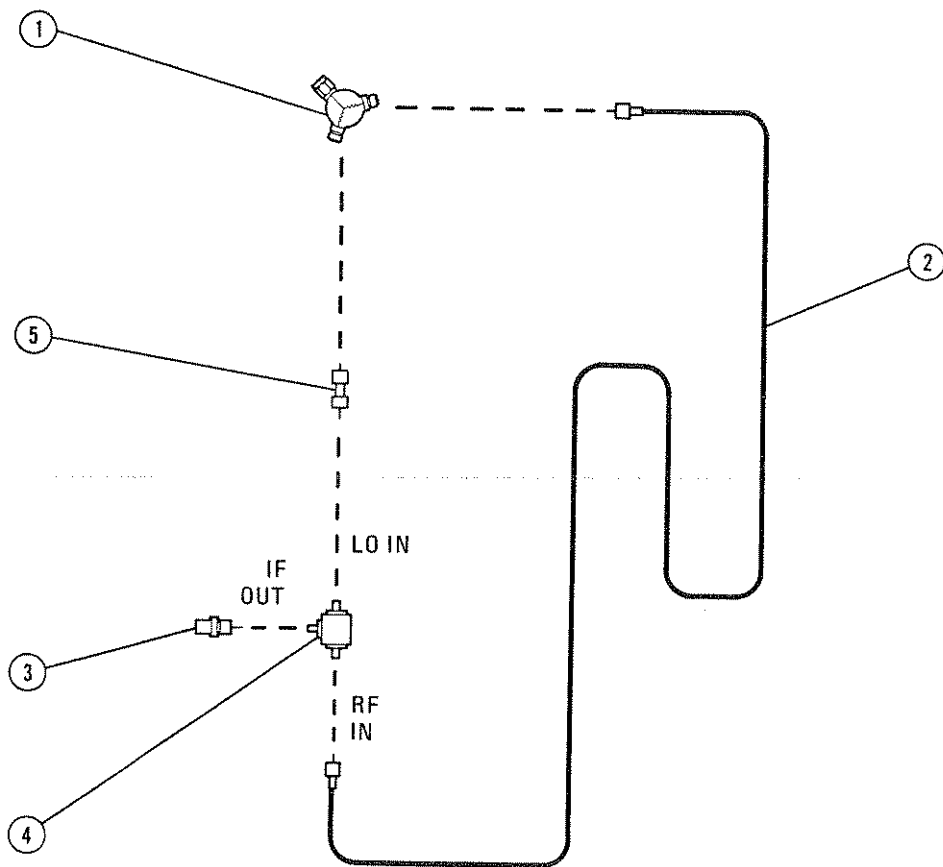

Item	Description	HP Part Number
1	Power Splitter	HP 11667B
2	Delay Line: >1 meter (3 feet) in length, SMA male connectors	08503-20038
3	Adaptor: BNC Female to SMA Male	1250-1200
4	Mixer: Doubled Balanced RHG Electronics Part Number DMS 1-26 RGH Electronics Laboratories, Inc., Deer Park, NY 11729	0955-0307
5	Adaptor: SMA Male to SMA Male	1250-1159

Figure 1-3. Delay Line Discriminator

Section II. Installation

INTRODUCTION

This section provides installation instructions for the HP 83570A RF plug in. This section also includes information about initial inspection, damage claims, preparation for use, packaging, storage, and shipment.

- Initial Inspection
- Preparation for Use
- Operating Environment
- Installation Instructions
- Storage and Shipment

INITIAL INSPECTION

Mechanical Inspection

Inspect the shipping container for damage. If the shipping container is damaged and/or the cushioning material shows signs of stress, keep them until the contents of the shipment have been checked for completeness and the instrument has been checked mechanically and electrically. Notify your nearest Hewlett-Packard office if there is mechanical damage or defect to the instrument. Keep all shipping materials for the carrier's inspection. Hewlett-Packard will arrange for repair or replacement without waiting for shipping damage claim settlement.

Electrical Inspection

NOTE: HP 83570A performance tests assume that the HP 8350 sweep oscillator is calibrated.

Procedures for checking electrical performance are given in Section IV, Performance Tests. If the HP 83570A does not pass an electrical performance test, the plug-in requires adjustment or repair. Each performance test refers you to the appropriate adjustment(s) in Section V. You can choose to adjust and, if necessary, repair the instrument yourself, or you can return it to Hewlett-Packard for service. If you have any questions contact your nearest Hewlett-Packard Sales and Service office.

PREPARATION FOR USE

RF Plug-in Configuration Switch

The HP 83570A RF plug-in has a configuration switch (A3S1) located on the A3 digital interface board. This switch must be reset prior to RF plug-in operation. Refer to Section III, Operation, for a complete description of the configuration switch and instructions on how to select switch settings to match your configuration needs.

Interconnections

To operate as a completely functional sweep oscillator, the HP 83570A RF plug-in must be installed in a HP 8350 sweep oscillator. There are two rear panel interconnections from the HP 83570A RF plug-in to the HP 8350 sweep oscillator. These are the RF plug-in interface connector (P2) and the power supply interface connector (P1). A complete listing of pins and associated signals for these connectors is provided in Figures 2-1 and 2-2.

Mating Connectors

All of the externally mounted connectors on the HP 83570A are listed in Table 2-1. Opposite each connector is an industry identification, the HP part number of a mating connector, and the part number of an alternate source for the mating connector. For HP part numbers of the externally mounted connectors themselves, refer to Section VI, Replaceable Parts, of this manual.

Table 2-1. HP 83570A Mating Connectors

HP 83570A Connector		Mating Connector	
Connector Name	Industry Identification	HP Part Number	Alternate Source
J1 RF OUTPUT AUX OUT	Type K42 waveguide Type N (f)	HP K281C 1250-0882	Speciality Connector 25-P117-2
J2 EXT/MTR ALC INPUT	BNC (f)	1250-0256	Speciality Connector 25-P118-1
J3 PULSE IN	BNC (f)	1250-0256	Specialty Connector 25-P118-1

Operating Environment

Temperature. The instrument may be operated in temperatures from 0° C to +55° C.

Humidity. The instrument may be operated in environments with humidity from 5% to 80% relative at +25° C to +40° C. However, the instrument should also be protected from temperature extremes which cause condensation within the instrument.

Altitude. The instrument may be operated at altitudes up to 4572 meters (15,000 feet).

Cooling. When the HP 83570A RF plug-in is properly installed in the HP 8350 sweep oscillator, it obtains all of its cooling airflow by forced ventilation from the fan in the HP 8350. A diagram showing the various cooling airflow paths within the sweep oscillator is given in Section II, Installation, of the HP 8350 sweep oscillator Operating and Service Manual. Ensure that all airflow passages in the HP 8350 and HP 83570A are clear before installing the RF plug-in in the sweep oscillator.

Installation Instructions

To install the HP 83570A RF plug-in in the HP 8350 sweep oscillator:

1. Turn the HP 8350 OFF.
2. Remove all connectors and accessories from the front and rear panel connectors of the HP 83570A to prevent them from being damaged.
3. Position the RF plug-in unit latching handle in the fully raised position. The handle should raise easily and be held by spring tension.

4. Ensure that the HP 8350 RF plug-in channel is clear, align the RF plug-in in the channel and slide it carefully into place. It should slide easily without binding.
5. The latching handle slot engages with the locking pin just before the plug-in is fully seated.
6. Press the latch handle downward, while still pushing in on the RF plug-in, until the handle is fully down and the front panel of the RF plug-in is aligned with the sweep oscillator front panel.

STORAGE AND SHIPMENT

Environment

The instrument may be stored or shipped in environments within the following limits:

Temperature	−40° C to +75° C
Humidity	5% to 95% relative at 0° C to +40° C
Altitude	up to 15240 meters (approximately 50,000 feet)

The instrument should also be protected from temperature extremes which may cause condensation in the instrument.

Packaging

Containers and materials identical to those used in factory packaging are available through Hewlett-Packard offices. A complete diagram and listing of packaging materials used for the HP 83570A is shown in Figure 2-4.

If, however, you choose to package the instrument with commercially available materials, follow these instructions:

1. Wrap the instrument in heavy paper.
2. Use a strong shipping container. A double-wall carton made of 159-kg (350-lb) test material is adequate.
3. Use shock-absorbing material, 76 to 102 mm (3 to 4 in) layer, around all sides of the instrument to provide a firm cushion and prevent movement inside the container.
4. Seal the shipping container securely.
5. Mark the shipping container **FRAGILE**.

Returning for Service

If you are shipping the RF plug-in to a Hewlett-Packard office or service center please include the following information:

1. Your company name and address.
2. A technical contact person within your company, and their complete phone number.
3. The complete model and serial number of the instrument.
4. The type of service required (calibration vs. repair).
5. Any other information that may expedite service.

A page of preprinted fill-in tags are provided for your convenience at the end of this section. When making inquiries, either by correspondence or by telephone, please refer to the instrument by model and full serial number.

POWER SUPPLY PLUG-IN INTERFACE CONNECTOR P1

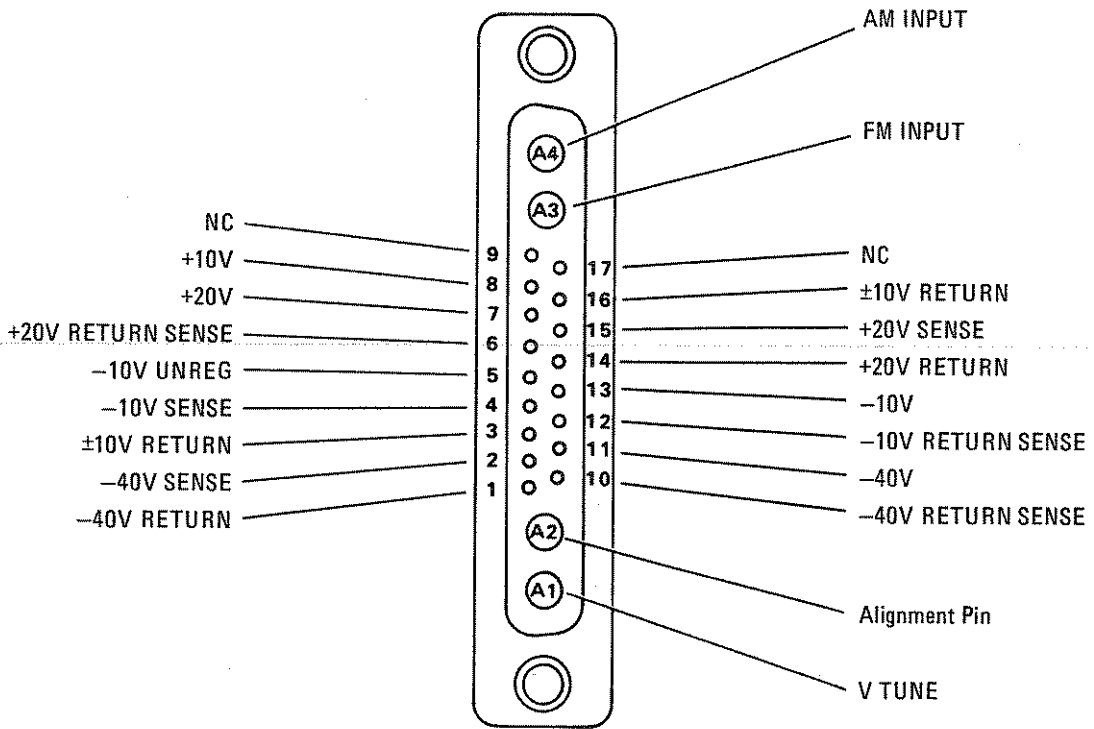

Figure 2-1. Interface Signals on Connector P1

PLUG-IN INTERFACE CONNECTOR P2

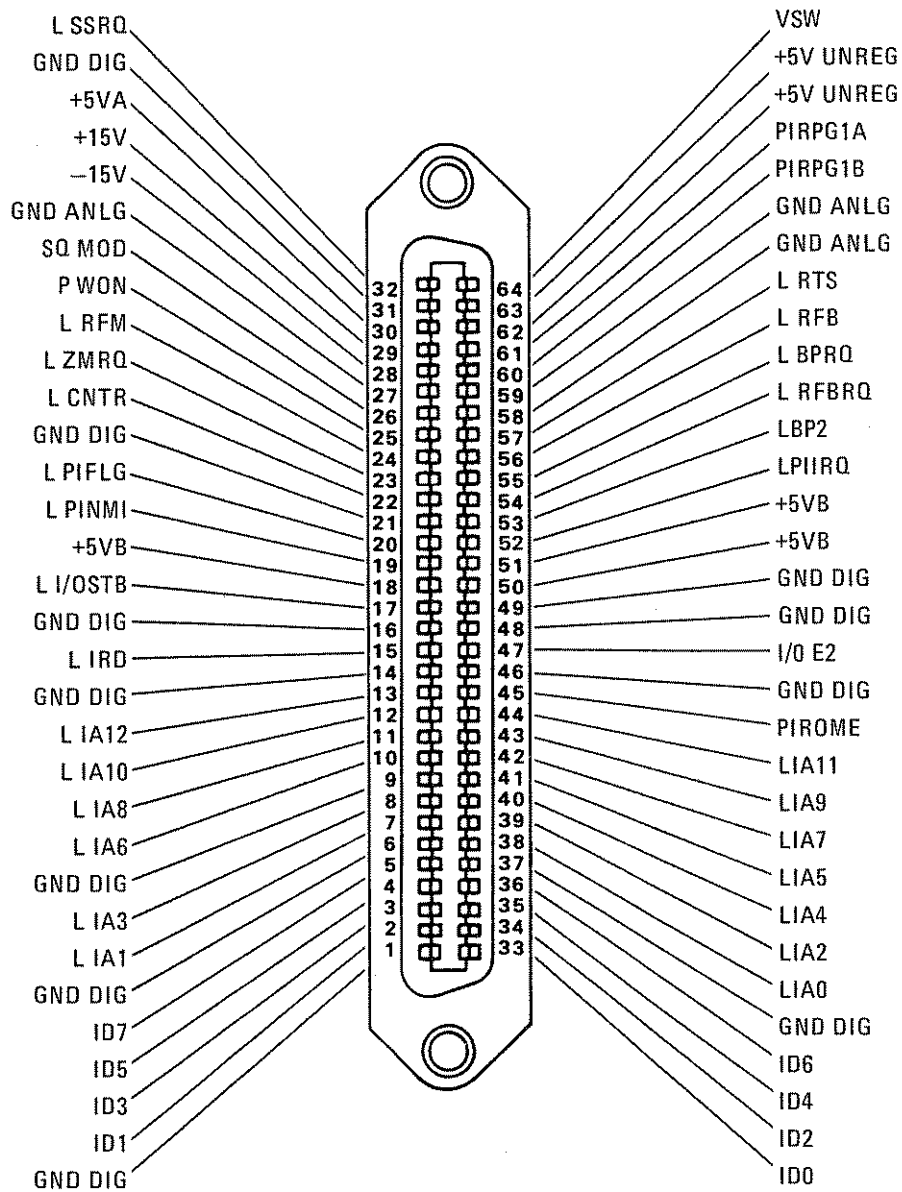
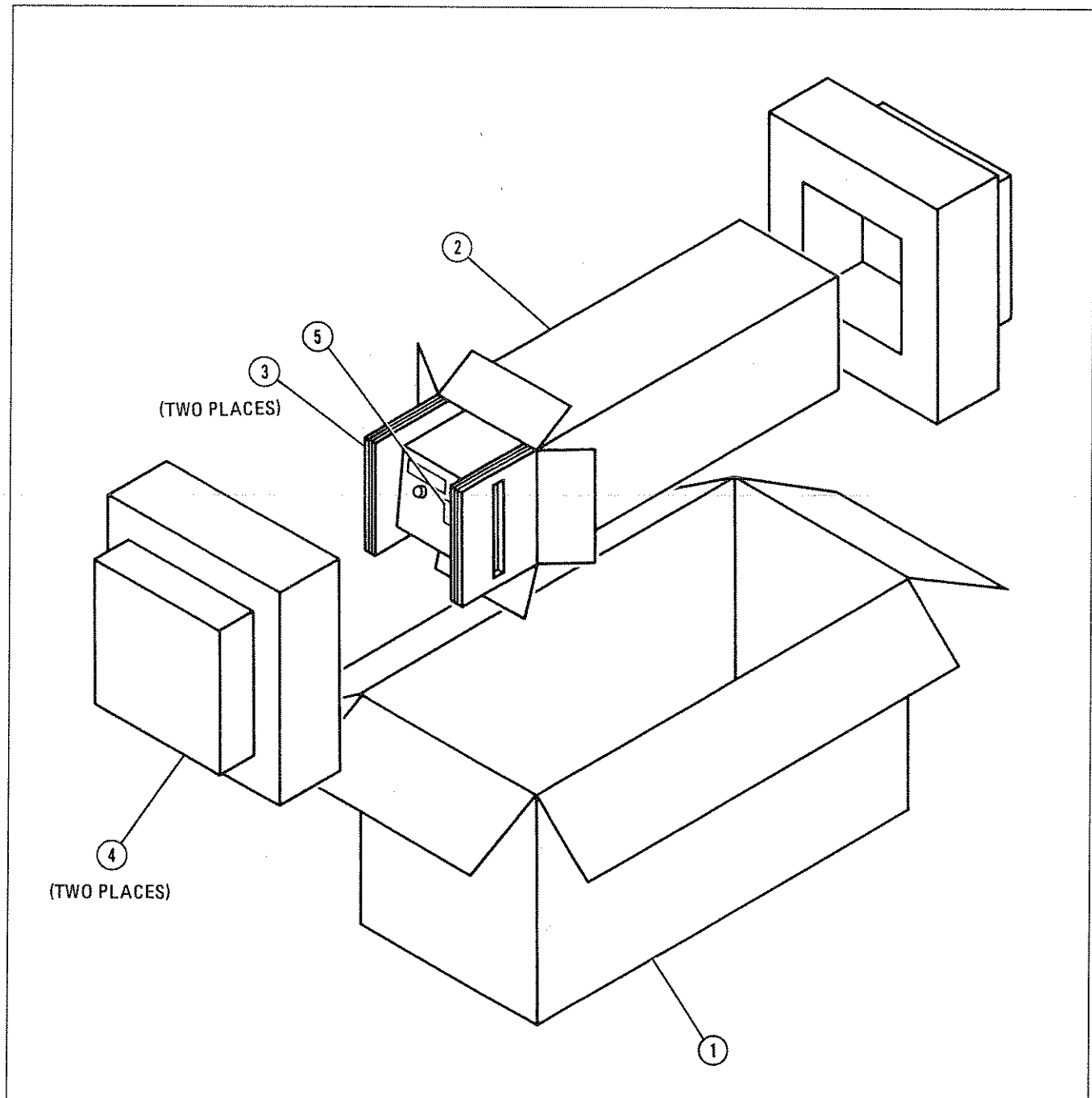

Figure 2-2. Interface Signals on Connector P2



Item	Quantity	HP Part Number	CD	Description
1	1	9211-3515	6	Outer Carton
2	1	9211-3514	5	Inner Carton
3	2	9220-3409	6	Side Pads - Corrugated Cardboard
4	2	9220-3406	3	Foam Pads
5	1	—	—	Waveguide Foam Insert
not shown	1	9222-0945	3	Antistatic Bag - to cover instrument

Figure 2-3. Packaging for Shipment Using Factory Packaging Materials

Section III. Operation

INTRODUCTION

This section is divided into four major sections:

OPERATING CHARACTERISTICS explains the frequency resolution characteristics in CW and swept modes.

FRONT AND REAR PANEL FEATURES.

OPERATING INSTRUCTIONS provides information on:

- RF plug-in configuration switch.
- Operator's checks.
- Internal, external detector, and power meter leveling.
- External FM modulation.
- RF power control.
- HP-IB
- Firmware revision number.
- Phase-lock operation.

OPERATOR'S MAINTENANCE includes information on:

- Plug-in error codes
- Fuses
- Service tags

OPERATING CHARACTERISTICS

FREQUENCY RESOLUTION

Two areas relating to frequency resolution must be considered; these are input resolution and displayed resolution. Input resolution refers to the number of bits (8 bits = 256 points) used in the HP 8350's digital to analog converters (DACs) to generate the tuning voltage for a particular mode of operation. Table 3-1 cross references input resolution with each DAC used. Displayed frequency resolution refers to the number of digits displayed on the HP 8350 FREQUENCY displays.

Input Resolution

Figure 3-1 is a simplified block diagram of the frequency tuning circuits in the HP 8350. The net tuning voltage results from the summation of the three DAC outputs. With this DAC configuration, the START/STOP sweep mode is computed by the microprocessor into a center frequency (CF) and a ΔF sweep width. Therefore the operation of all sweeps are set with a center frequency and sweep width. The center frequency is specified by the center frequency (CF) DAC and the vernier DAC, and the sweep width is determined by the ΔF DAC.

The CF DAC has 12 bits, hence 4096 points across the plug-in frequency band (including a 2% overrange and a 2% underrange of the band). The analog output ranges from zero to ten volts, which is used to specify the center frequency output of the plug-in. These parameters give the CF DAC a resolution of 0.024% (2.4mV) over the full band (including overrange).

Resolution of center frequency is enhanced by a summed voltage generated by an 8-bit (256 points) vernier DAC. Vernier range is set to $\pm 0.048\%$ of RF plug-in bandwidth (including overrange). Vernier resolution is determined by dividing $\pm 0.048\%$ bandwidth by 256 points (128 points either side of CF). The voltage range of the total 256 points on the vernier DAC is equal to four points on the 12-bit CF DAC (two points on either side of CF). This increases CF resolution from 0.024% (2.4mV) to 0.00038% (.04mV), and improves the relative accuracy of the CF by a similar factor. The absolute resolution accuracy still depends on the CF DAC.

NOTE: When adjusting the vernier through its end point, the CF DAC is incremented or decremented by the total value of the vernier (2 points on the CF DAC). At this time the accuracy of the center frequency is again entirely dependent on the linearity of the CF DAC, 0.005% of bandwidth.

Table 3-1. Input Resolution

DAC Used	Voltage Resolution	Frequency Resolution
CF	2.50 mV	2.158 MHz
Vernier	40 μ V	33.721 kHz
ΔF 1 - 1/8 of band	10.0 mV	8.84 MHz
ΔF 1/8 - 1/64 of band	1.25 mV	1.11 MHz
$\Delta F \leq 1/64$ of band	0.156 mV	138 kHz

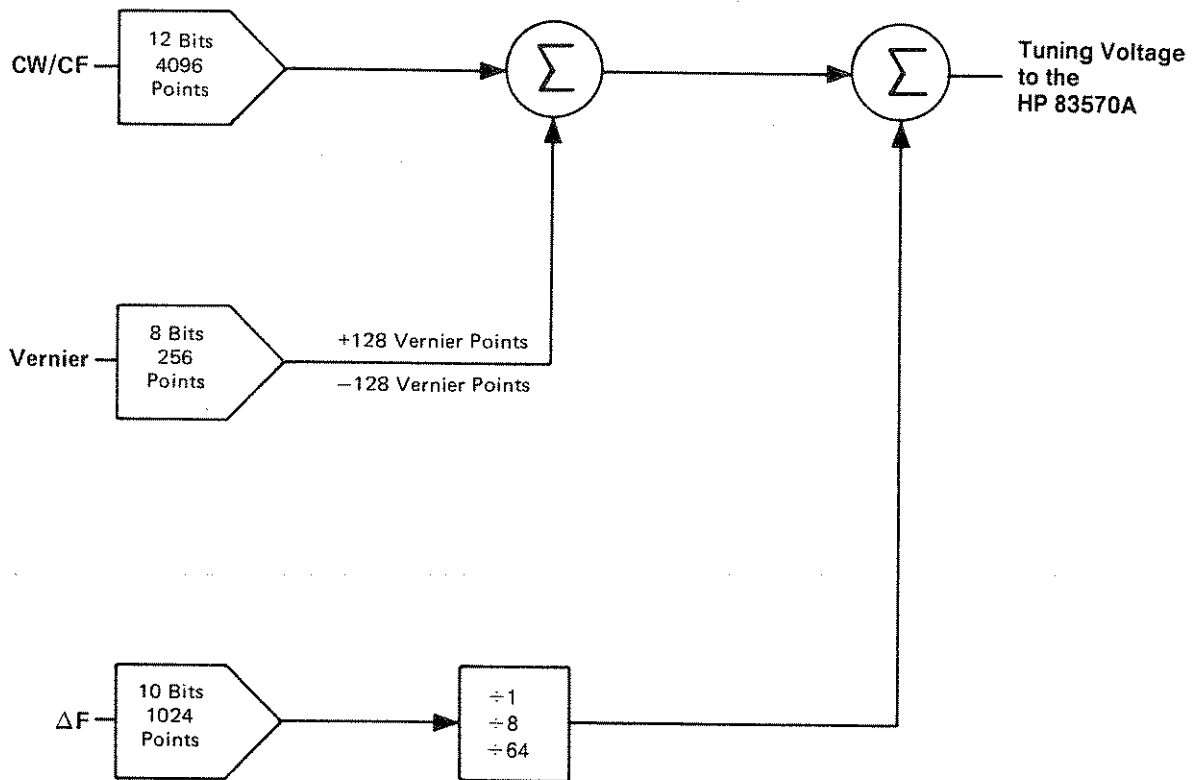

Figure 3-1. Simplified Tuning Voltage Block Diagram

The ΔF DAC has 10 bits (1024 points). The analog input to this DAC ranges from -10 to $+10$ volts to produce an even sweep on either side of the center frequency. The ΔF resolution improves with narrower sweep widths. For broad sweeps, the resolution is 0.1% of the full band. Greater resolution is provided for sweep widths less than $1/8$ of the full band range. At these sweep widths, the resolution is improved to 0.012% of the full band. The greatest resolution is provided for sweep widths less than $1/64$ of the full band range. At these sweep widths, the resolution is further improved to 0.0015% of the full band.

Display Resolution

Center frequency in the CW mode, is always displayed with 1 MHz resolution. The display resolution for center frequency varies from 10 MHz to 1 MHz depending on the span width (for $\Delta F \geq 8.53$ GHz, 1 MHz) when in the CF mode. Likewise, Vernier values are always displayed at a 100 kHz resolution. The display resolutions for ΔF values vary with sweep width (Table 3-2 shows the ΔF mode displayed resolution values versus displayed ΔF frequency sweep widths).

Table 3-2. ΔF Sweep Mode Displayed Resolution

		ΔF Displayed Frequency Width			
		0 MHz	52.7 MHz	4.215 GHz	8.5 GHz
Displayed Resolution		100 kHz	1 MHz	10 MHz	
	ΔF Display Indication	0.00 MHz	0 MHz 0.000 GHz	0.00 GHz	

FRONT PANEL FEATURES

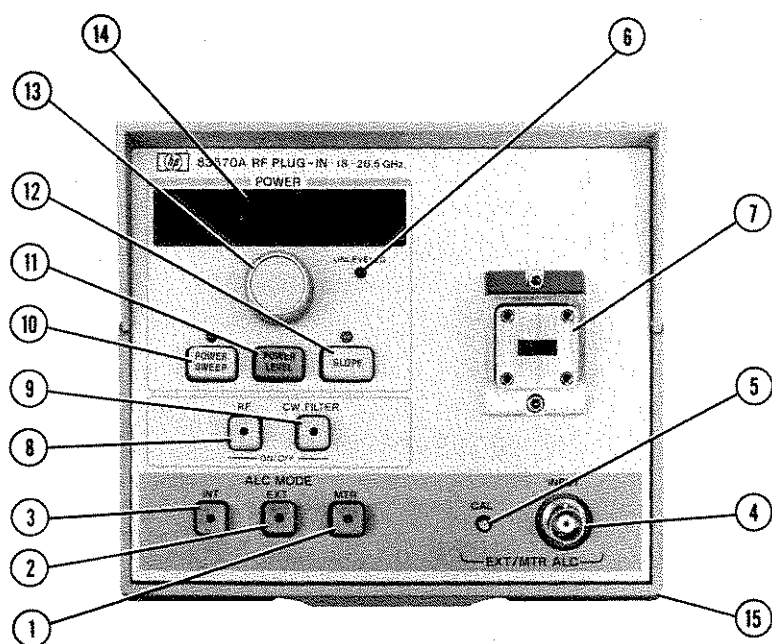

Figure 3-2. Standard Front Panel

1. **[MTR]**. Power meter automatic leveling control selection.
2. **[EXT]**. External automatic leveling control selection (negative crystal detector).
3. **[INT]**. Internal automatic leveling control selection. Selects the RF plug-in's internal crystal detector/coupler for leveling the output power at the front panel output connector.
4. **ALC INPUT**. BNC connector for power meter or external crystal leveling inputs.
5. **CAL**. Offset control for calibrating output power when leveling with a power meter or an external crystal detector.
6. **UNLEVELED** lamp. This lights if the output power is unlevelled.
7. **RF OUTPUT**. Type R42 waveguide connector.
8. **[RF ON/OFF]**. Turns RF power on or off. Used when zeroing a power meter, or zeroing an AC/DC detector in DC mode or referencing an X-Y recorder.
9. **[CW FILTER]**. In CW mode, enables an oscillator tuning voltage filter to remove FM noise at the RF output (automatically disabled in swept mode).
10. **[POWER SWEEP]**. Used to set an increase or decrease in the power relative to sweep (dB/SWP).
11. **[POWER LEVEL]**. Used to set the RF output power level.

12. **[SLOPE]**. Used to set the frequency slope compensation in \pm dB/GHz (for use with lossy devices or waveguide).
13. **POWER CONTROL KNOB**. Used to control power level, power sweep, or slope.
14. **POWER DISPLAY**. Provides a readout of the selected power in dBm (to a tenth of a dB), dB/GHz (to a hundredth of a dB), or dB/SWP (to a tenth of a dB).
15. **PLUG-IN LATCH HANDLE**. Used to remove, install, and latch the RF plug-in into the HP 8350 sweep oscillator.

REAR PANEL FEATURES

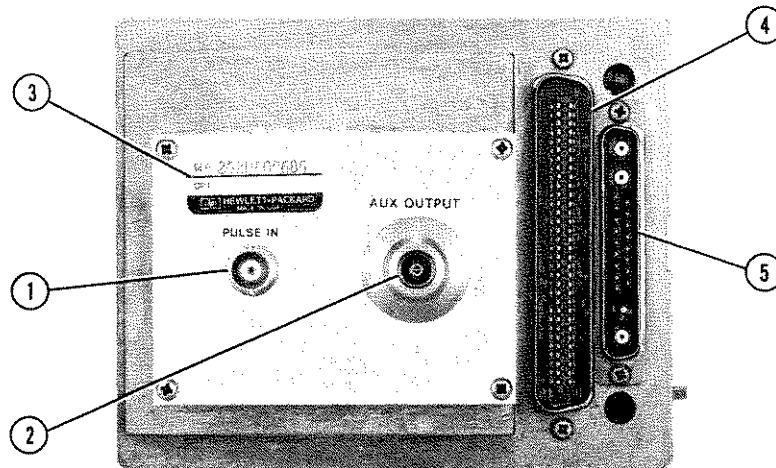

Figure 3-3. Rear Panel Features

1. **PULSE INPUT.** External pulse or square wave modulation input (TTL levels).
2. **AUX OUTPUT.** Type-N, 50 ohm connector that provides an unlevelled signal half the output frequency.
3. **SERIAL NUMBER LABEL.** Contains a ten digit serial number (for use in any correspondence concerning the plug-in) and applicable option number(s).
4. **RF PLUG-IN INTERFACE CONNECTOR.** Connector through which the RF plug-in receives and sends digital and analog signals from and to the HP 8350.
5. **RF PLUG-IN POWER SUPPLY INTERFACE CONNECTOR.** Connector through which the RF plug-in receives required power supplies, AM input, FM input, and VTUNE from the HP 8350.

OPERATING INSTRUCTIONS

RF PLUG-IN CONFIGURATION SWITCH

The RF plug-in configuration switch is located on the digital interface assembly (A3), as shown in Figure 3-4.

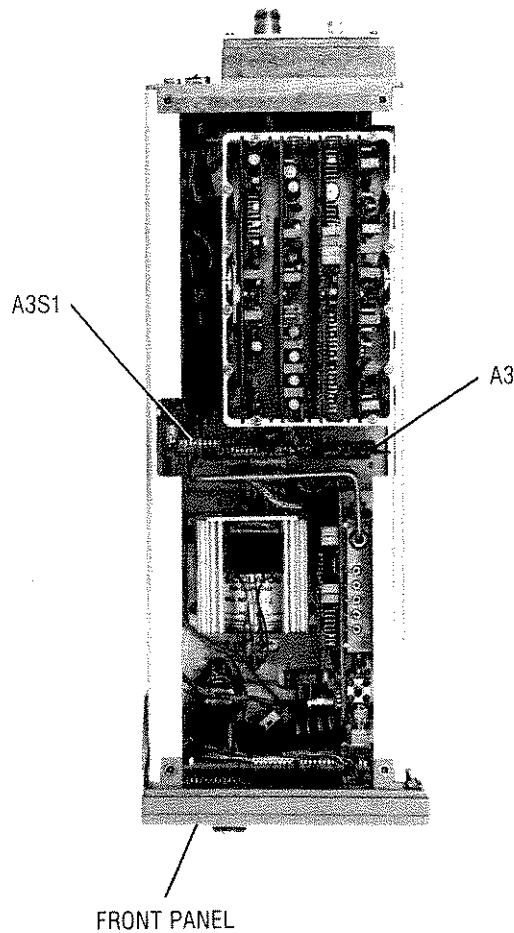

Figure 3-4. RF Plug-In Configuration Switch Location

Configuration switch A3S1 is set at the factory for a combination of operating modes (see Table 3-3). Using three of the eight switch sections, you can select other operating modes. Table 3-3 defines each switch segment and the position of each for the different operating modes.

NOTE: Configuration switch settings override the HP 8350 memory settings at instrument preset. If you change the switch settings, you must press **[INSTR PRESET]** to load memory with the new configuration.

Table 3-3. RF Plug-In Configuration Switch Settings

DESCRIPTION	SWITCH NUMBER							
	1	2	3	4	5	6	7	8
Code for HP 83570A Plug-in	0	0	1	X	X	X	X	X
No RF Power at Instrument Preset	X	X	X	1	X	X	X	X
RF Power at Instrument Preset	X	X	X	0	X	X	X	X
-6 MHz/V FM Sensitivity	X	X	X	X	1	X	X	X
-20 MHz/V FM Sensitivity	X	X	X	X	0	X	X	X
Direct-Coupled FM	X	X	X	X	X	1	X	X
Cross-Over Coupled FM	X	X	X	X	X	0	X	X

Switch A351 is set from the factory as follows:

Switch No.	Position
1	0
2	0
3	1
4	0
5	0
6	0
7	X
8	X

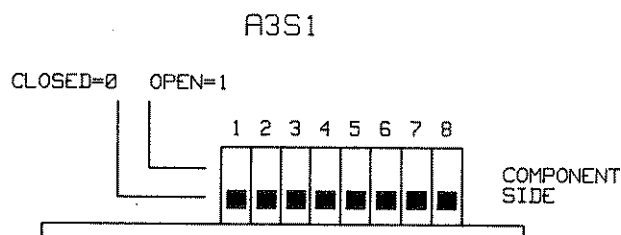

Switch positions:

- 1 = Open = High
- 0 = Closed = Low (Ground)
- X = Don't Care

OPERATOR'S CHECKS

The Operator's Checks found under the Operating Information portion of the *HP 8350 Sweep Oscillator Operating and Service Manual* provides a quick evaluation (Local and Remote) of the main functions of both the HP 8350 and the 83570A.

If the instruments do not pass the operator's checks, the trouble may be in either unit. If you suspect the RF plug-in, refer to Section VIII, Service.

INTERNAL LEVELING

Internal leveling is the most convenient method of RF output leveling (the default mode at INSTRUMENT PRESET). A portion of the RF output power is internally coupled/detected and the resulting DC voltage is applied to the automatic leveling control circuit (ALC) to maintain a constant power output. The DC voltage is proportional to the RF power at low power levels and at high power levels the voltage is proportional to the RF voltage.

EXTERNAL CRYSTAL DETECTOR LEVELING

The RF output power can be leveled externally using a two resistor power splitter (or external directional coupler) and a negative output crystal detector. The advantage of a directional coupler is that it does not have as great a coupled loss as the 6 dB insertion loss of the power splitter, so you can obtain a higher maximum leveled output power, however it will typically have more ripple and slope.

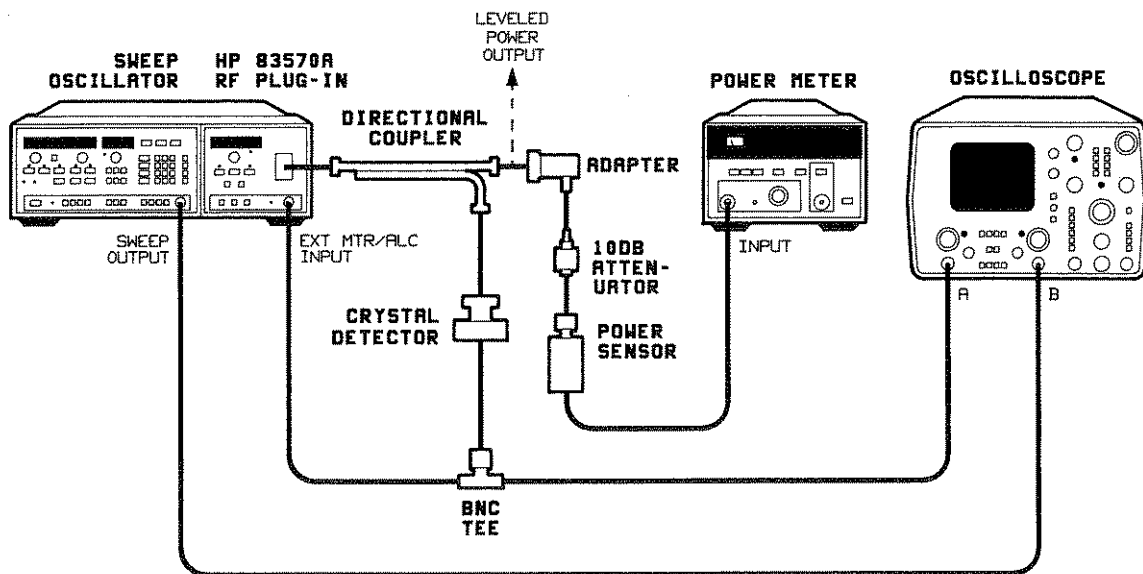

Figure 3-5. External Crystal Detector Leveling Set Up

Equipment

Sweep Oscillator	HP 8350
Power Meter	HP 436A
Power Sensor	HP 8485A
Crystal Detector	HP K422A
Directional Coupler	HP K752C
BNC Tee	HP Part No. 1250-0781
10 dB Attenuator	HP 8493C, Opt 010
Adapter Waveguide to 3.5mm (m)	HP K281C
Oscilloscope	HP 1741A

Procedure

1. Connect the equipment as shown in Figure 3-5. Turn the instruments on and allow them to warm up for at least 30 minutes.
2. On the HP 8350, press **[INSTR PRESET] [CW]**.
3. On the HP 83570A, press **[EXT]**, and adjust the CAL adjustment for a power meter reading equal to the reading on the plug-in front panel.
4. To use leveled RF power output to test external equipment, make the connection at the point marked Leveled Power Output in Figure 3-5.

EXTERNAL POWER METER LEVELING

RF output power can be leveled using a power meter and a directional coupler (or power splitter). Power meters that are compatible with the HP 83570A for power meter leveling applications are the HP 432A/B/C, 436A, and 438A. For power meter leveling (**ALC MODE [MTR]**), the power meter is used in conjunction with the internal leveling loop. Low frequency variations are handled by the power meter and high frequency variations are handled by the internal leveling loop. When using power meter leveling, limit the sweep time to 50 seconds for best power level accuracy. A sample of the RF output signal is routed to a power meter which produces a dc voltage proportional to the RF signal level. This dc signal is applied to the HP 83570A ALC circuits and compared with an internal reference voltage. A difference voltage is produced and amplified by the ALC amplifier before being applied, as modulator drive, to a PIN Modulator. Figure 3-6 illustrates a typical power meter leveling setup.

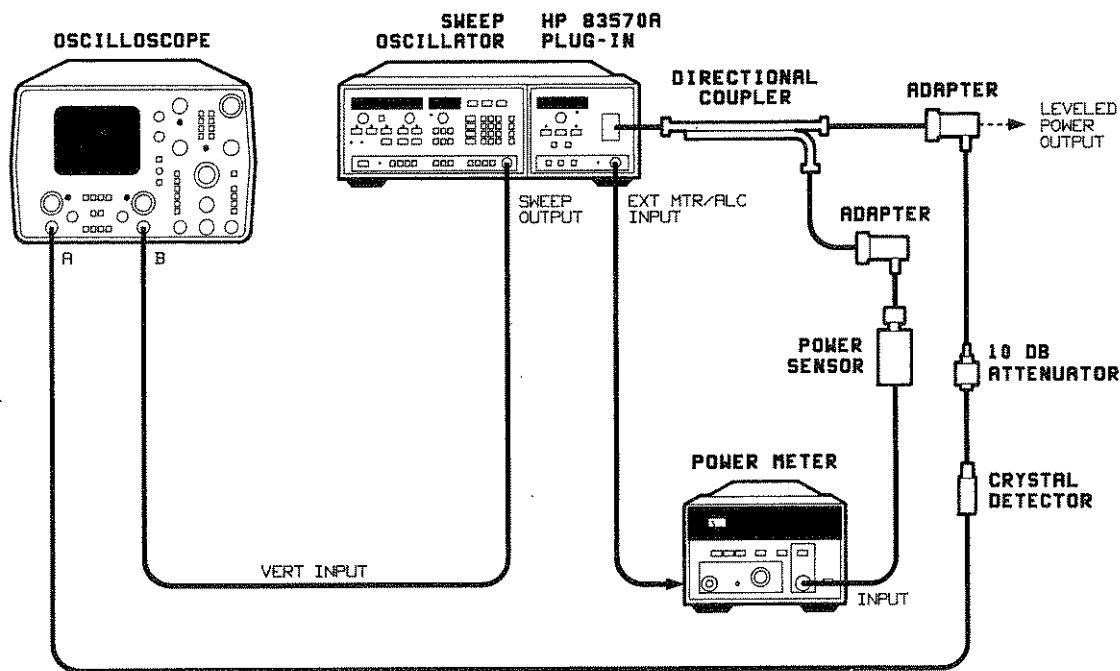

Figure 3-6. External Power Meter Leveling Set Up

Equipment

Sweep Oscillator	HP 8350
Power Meter	HP 436A
Power Sensor	HP 8485A
Oscilloscope	HP 1741A
Crystal Detector	HP 8473C
Directional Coupler	HP K752C
10 dB Attenuator	HP 8493C Option 010
(2) Adapter Waveguide to 3.5 mm (m)	HP K281C

Procedure

1. Turn the instruments on and allow 30 minutes for warmup.
2. Zero and calibrate the power meter/sensor.
3. Connect the equipment as shown in Figure 3-6.
4. On the HP 8350:
 - Press **[INSTR PRESET]**.
 - Set SWEEP TIME to 100 sec.
5. On the HP 83570A:
 - Press **[MTR]** to select external power meter leveling.
 - Set the power to maximum specified leveled output power (+10 dBm).
 - Adjust the ALC CAL for a -10 dBm reading on the power meter.

6. On the HP 8350:

Press [**SINGLE**] to set the single sweep mode. Press [**SINGLE**] again to start a sweep. Note that if you press [**SINGLE**] a third time, the sweep stops. Once single sweep is set, this key acts like an on/off switch for the sweep.

To use leveled RF output power for testing external equipment, make the connection at the point marked Leveled Power Output, in Figure 3-6.

EXTERNAL FM

You can frequency modulate (FM) the HP 83570A RF output signal by applying an external modulation signal to the HP 8350 rear panel FM INPUT connector. A positive going voltage at the FM INPUT causes the output frequency to increase, while a negative going voltage causes the output frequency to decrease.

You can set the sensitivity of the modulating signal via the RF plug-in configuration switch (A3S1) (refer to Table 3-3). The coupling is set for cross-over coupling and is not changeable.

RF POWER CONTROL

Power Level

The standard HP 83570A provides a maximum leveled RF output power of +10 dBm. A front panel LED indicates when the RF output becomes unleveled. The power level is controlled by the front panel rotary pulse generator (RPG), the HP 8350 data entry controls (keypad and step keys), or through HP-IB control via the HP 8350. This function when enabled allows setting the output power level for all ALC modes. Calibrated power level is available during internal leveling only.

You can turn off the RF output with the [**RF ON/OFF**] key. Power ON is indicated by the LED in the center of the key. You can set the HP 83570A to have either maximum leveled output power or RF power OFF at INSTRUMENT PRESET. Refer to Table 3-3 for the proper configuration switch setting (A3S1).

Power Sweep

When this function is enabled (LED on) the RF output power can be swept both positively and negatively over a selected power range. The level of the power sweep starting point is the power level programmed before the power sweep function is turned on. The settable range is 0 to +25.5 dB/SWP and is limited by the dynamic range of the ALC loop.

The power sweep width can be entered via the keyboard, step keys, or the RF plug-in RPG. The level of the power sweep end point is determined by the sum of the starting power level and the sweep width. Power sweep is turned off and reset to 0 dB/SWP whenever INSTRUMENT PRESET is initiated.

Slope

When this function is enabled (LED on) the frequency slope compensation can be set via the keyboard, step keys or the RF plug-in RPG. It allows positive slope compensation for devices with linear losses proportional to frequency (cables) and negative slope compensation for devices with losses inversely proportional to frequency (waveguide). The settable range is 0 to +5 dB/GHz and is limited by the dynamic range of the ALC loop. Slope is turned off and reset to 0 dB/GHz whenever INSTRUMENT PRESET is initiated.

Because of hardware/firmware limitations, the level of the power sweep end point due to slope compensation, can not be greater than the difference between maximum leveled power and the starting level of power sweep divided by the frequency span being swept. The calculation below summarizes this statement as follows:

$$\text{SLOPE dB/GHz} = \frac{\text{MAL LEV PWR} - \text{START PWR}}{\text{FREQ SPAN}}$$

HP-IB

All front panel functions, except for the ALC CAL adjustment can be altered by computer control via the HP-IB connection on the HP 8350.

FIRMWARE REVISION NUMBER

Press [SHIFT] [9] [9] on the HP 8350. The plug-in firmware revision number appears in the HP 83570A POWER display window. Various measurement systems (scalar, vector network analyzers) require a specific firmware revision.

PHASE-LOCK OPERATION

The HP 83570A RF output (CW) signal may be phase-locked using an external phase-lock signal applied to the HP 8350 sweep oscillator FM INPUT connector (rear panel). The phase-lock function provides a means of obtaining a very stable CW frequency by transferring the frequency stability of the reference oscillator to the source. If the CW frequency starts to drift, the phase difference between the CW frequency and the reference frequency (reference oscillator) is detected, producing a dc voltage. The dc voltage is a correction signal which restores the CW frequency to its previous point. Stability of this CW frequency is determined by the stability of the reference oscillator. The CW filter should be turned off in phase lock operation.

OPERATOR'S MAINTENANCE

PLUG-IN ERROR CODES

The sweep oscillator CW/START/CF display will display plug-in error codes (50 to 99) or sweep oscillator error codes. Information on plug-in error codes may be found in Section VIII (**SELF TEST** and *Table 8-2*).

FUSES

HP 83570A power supplies are fused in the HP 8350 sweep oscillator. Refer to the *HP 8350 Sweep Oscillator Operating and Service Manual* for fuse locations and replacement instructions.

BLUE SERVICE TAGS

If the HP 83570A requires service, you can send the instrument to your local HP service organization, as described in Section II, Installation. Before sending the instrument in, fill out and attach one of the blue service tags. On the FAILURE SYMPTOMS/SPECIAL CONTROL SETTINGS portion of the tag, record any error codes noted.

Section IV. Performance Tests

INTRODUCTION

The procedures in this section test the electrical performance of the HP 8350 Sweep Oscillator/83570A RF plug-in combination, with the plug-in specifications used as the performance standards. The plug-in specifications are listed in Table 1-1, Section I, General Information. These performance tests do not require access to the interior of the HP 83570A RF plug-in.

NOTE: Allow the HP 8350 Sweep Oscillator/83570A RF plug-in combination to warm-up for at least one hour before you begin any performance tests.

EQUIPMENT REQUIRED

The equipment required to test the HP 83570A is listed in the Recommended Test Equipment Table in Section I, General Information. Any equipment that satisfies the critical specifications given in the table can be substituted for the recommended model.

OPERATION VERIFICATION

Operation Verification consists of performing the following tests:

- Frequency Range and Accuracy
- Output Amplitude

The HP-IB functions can be verified using the program listed in Section IV of the *HP 8350 Operating and Service Manual*.

These tests provide reasonable assurance that the sweep oscillator and plug-in are functioning properly and should meet the needs of an incoming inspection (80% verification).

TEST RECORDS

Table 4-6 provides a tabulated index of the performance tests, their acceptable limits, and a column for recording actual measurements. Use this test record when performing a calibration.

Table 4-7 is the test record to use for recording the results of an operational verification. A column for recording pass/fail indications is provided.

RELATED ADJUSTMENTS

Table 4-1 lists the performance tests, and references associated adjustments for each test that is provided in Section V of this manual. If the result of a performance test is out of the specified limits, the associated adjustment may correct this condition.

TEST SEQUENCE

Perform the tests in the order that they appear.

CALIBRATION CYCLE

For the HP 83570A, perform the tests in this section at intervals of twelve months or less.

Table 4-1. Performance Tests and Related Adjustments

Performance Tests	HP 83570A Adjustment
4-1. Frequency Range and Accuracy CW Accuracy Swept Frequency Accuracy Marker Accuracy	5-4. Frequency Accuracy 5-2. -10V Reference on A6 YO Driver 5-3. A6 YO Driver DAC Calibration 5-4. Frequency Accuracy 5-5. Delay Compensation 5-6. ALC Adjustment 5-2. -10V Reference on A6 YO Driver 5-3. A6 YO Driver Board DAC Calibration 5-4. Frequency Accuracy 5-5. Delay Compensation
4-2. Output Amplitude Maximum Leveled Power Output Power Variation Power Level Accuracy Power Sweep	5-7. Internal Leveled Flatness 5-8. Power Calibration 5-9. ALC Gain Adjustment 5-7. Internal Leveled Flatness 5-10. Power Sweep
4-3. Frequency Stability Test	
4-4. Residual FM Test	
4-5. Spurious Signals Test	
4-6. External Frequency Modulation Test	5-11. FM Driver
4-7. Square-Wave On/Off Ratio	

4-1. Frequency Range and Accuracy Test

SPECIFICATION

Frequency Range:	18.0 to 26.5 GHz
Frequency Accuracy (20° to 30° C):	
CW Mode	± 30 MHz
All Sweep Modes (sweep ≥ 100 ms)	± 55 MHz
Frequency Markers (sweep ≥ 100 ms)	± 55 MHz ± 0.5% of sweep width

DESCRIPTION

A frequency counter is used to check frequency range and accuracy in the CW mode. The frequency counter is also used to check swept frequency accuracy and markers in the START/STOP mode.

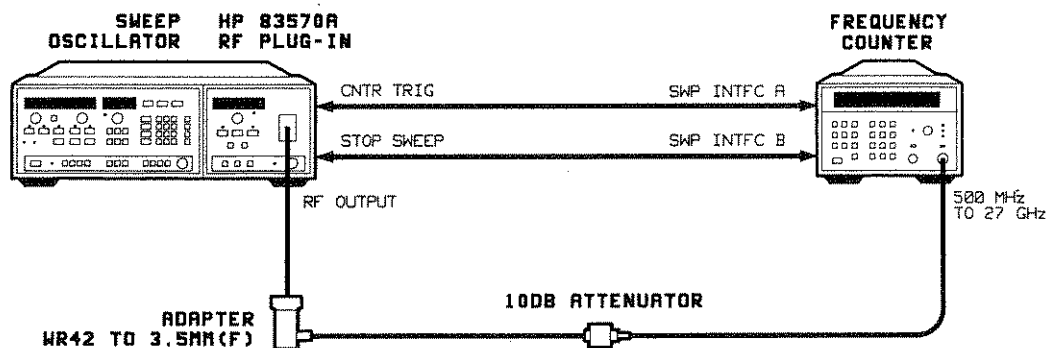

Figure 4-1. Frequency Range and CW Accuracy Test Setup

EQUIPMENT

Sweep Oscillator Mainframe	HP 8350
Frequency Counter	HP 5343A
10 dB Attenuator	HP 8493C Option 010
Cables (2), SMB (f) to BNC (m)	HP Part No. 08350-60039
Adapter 3.5 mm (f) to WR42	HP K281C

PROCEDURE

1. Connect the equipment as shown in Figure 4-1 and press **[INSTR PRESET]** on the HP 8350/83570A. Allow at least one hour warm-up. Note that the sweep oscillator display indicates a start frequency of 18.0 GHz and a stop frequency of 26.5 GHz.

4-1. Frequency Range and Accuracy Test (Cont'd)

2. On the frequency counter, set the controls as follows:

LINE	ON
SAMPLE RATE	minimum (full CCW)
Range Connector	As required
Impedance Switch	50 Ω
ACQ TIME (rear panel)	FAST

Frequency Range

3. Press **[CW] [1] [8] [GHz]**. If the frequency counter reads greater than 18.00 GHz, rotate the HP 8350 CW control counterclockwise until the frequency counter reads 18.000 GHz or lower. Record this reading on the test record.
4. Press **[CW] [2] [6] [.] [5] [GHz]**. If the frequency counter reads lower than 26.5 GHz, rotate the CW control clockwise until the frequency counter reads 26.500 GHz or higher. Record this reading on the test record.

CW Frequency Accuracy

Table 4-2. CW Frequency Accuracy

CW Frequency	Accuracy
18.50 GHz	± 30 MHz
22.25 GHz	± 30 MHz
26.50 GHz	± 30 MHz

5. Check the CW frequency accuracy for each CW frequency listed in Table 4-2. Verify that the frequency counter indication at these points is within the accuracy tolerance specified. Record the readings on the test record.

Swept Frequency Accuracy

6. On the frequency counter, press **[RESET] [SWP M]** (light on), **[Blue Key] [1 kHz]**.
7. On the sweep oscillator/RF plug-in:
Press **[INSTR PRESET]** and set the sweep time to 105 msec.
8. Press **[START] [SHIFT]** and **[M2]**. Check the frequency counter reading for a start frequency of 18 GHz ± 55 MHz and record the reading on the test record.
9. Press **[STOP] [SHIFT]** and **[M2]**. Check the frequency counter for a stop frequency of 26.5 GHz ± 55 MHz and record the reading on the test record.

4-1. Frequency Range and Accuracy Test (Cont'd)

Frequency Marker Accuracy

Table 4-3. Frequency Marker Accuracy

Sweep Range	Marker Frequencies				
	M1	M2	M3	M4	M5
18.0 to 26.5 GHz	20 GHz	22 GHz	23.5 GHz	25 GHz	26 GHz

10. Set the HP 8350 markers to the frequencies listed in Table 4-3.
11. Press **[SHIFT] [M2]**, and the first marker. Verify that the frequency counter reads within its tolerance.
12. Repeat step 11 for each marker. Record the readings on the test record.

4-1A. Alternate Swept Frequency and Marker Accuracy Test

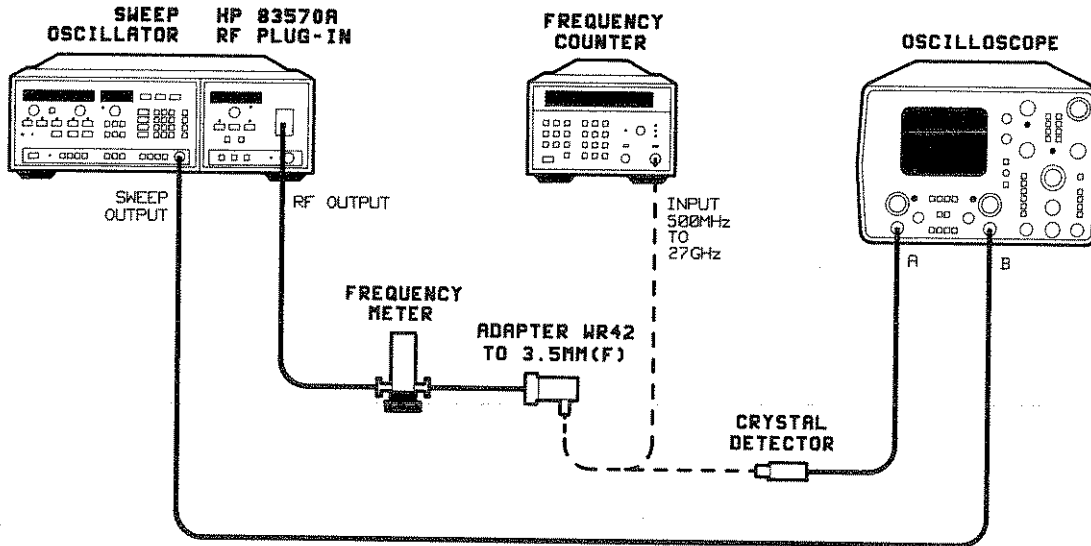

Figure 4-1A. Alternate Swept Frequency Accuracy Test Setup

EQUIPMENT

Sweep Oscillator Mainframe	HP 8350
Crystal Detector	HP 8473C
Frequency Counter	HP 5343A
Oscilloscope	HP 1741A
Frequency Meter 18.0 to 26.5 GHz	HP K532A
Adapter WR42 to 3.5 mm (f)	HP K281C

PROCEDURE

- 1A. Connect equipment as shown in Figure 4-1A.
- 2A. On the sweep oscillator/RF plug-in:
Press [INSTR PRESET] then set sweep time to 105 msec.

NOTE: To use the frequency meter for swept and marker frequency accuracy, first calibrate the frequency meter. Calibrate the meter by using the frequency counter to set the HP 8350 swept CW frequency to each frequency listed on the test record, then connect the oscilloscope and adjust the frequency meter to dip trace. Record difference between actual and frequency meter reading.

4-1A. Alternate Swept Frequency and Marker Accuracy Test (Cont'd)

Swept Frequency Accuracy

- 3A. Adjust the frequency meter to move the notch on oscilloscope trace to the start frequency. Check and record corrected frequency meter reading on test record.
- 4A. Adjust frequency meter to move the notch on oscilloscope trace to the stop frequency. Check and record corrected frequency meter reading on test record.

Frequency Marker Accuracy

- 5A. On the sweep oscillator/RF plug-in:
Press **[INSTR PRESET]** and set sweep time to 105 msec.
- 6A. Set the HP 8350 frequency markers to the frequencies listed in Table 4-3. Adjust the frequency meter notch over each marker and record the corrected frequency meter reading on the test record.

4-2. Output Amplitude Test

SPECIFICATION

Maximum Leveled Output Power (20° to 30° C)

Standard: +10 dBm

Power Variation (at specified maximum leveled power)

Internally Leveled: ±1.4 dB

Power Level Accuracy (20° to 30° C)

Internally Leveled: ±1.8 dB

Minimum Settable Power: -1 dBm

DESCRIPTION

A power meter is used to check power level accuracy, maximum leveled output power, and power variations.

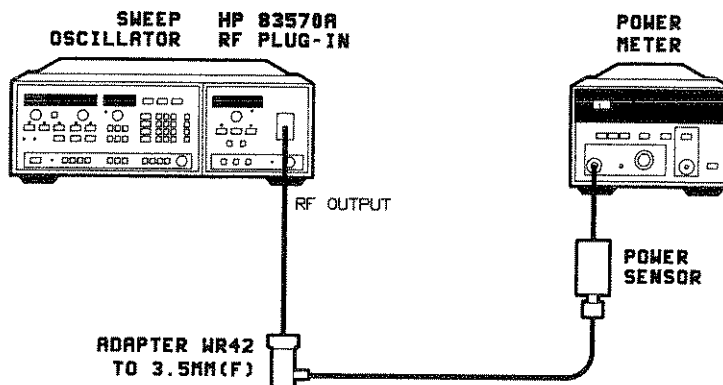

Figure 4-2. Output Amplitude Test Setup

EQUIPMENT

Sweep Oscillator Mainframe	HP 8350
Power Meter	HP 436A
Power Sensor	HP 8485A
Adapter WR42 to 3.5 mm (f)	HP K281C

4-2. Output Amplitude Test (Cont'd)

PROCEDURE

1. Connect the equipment as shown in Figure 4-2. Do not connect the power meter/sensor to the HP 83570A power output. Allow at least one hour of warm-up.

2. On the power meter/sensor:

Press [dBm] mode.

Zero and calibrate the power meter. Set the CAL FACTOR to 100%. By leaving the CAL FACTOR set at 100% it ensures minimum specifications will be met.

3. On the sweep oscillator/RF plug-in:

Press [INSTR PRESET]. Press SWEEP [MAN].

Maximum Leveled Power

4. Connect the power meter/sensor to the RF plug-in power output.

5. On the sweep oscillator/RF plug-in:

Slowly tune the FREQUENCY/TIME control and note the minimum power level in the range. Set the frequency at this low power point, press [MAN] [X] [X] [.] [X] [X].

6. Adjust the POWER LEVEL control for a power meter reading of maximum leveled power (UNLEVELED light off). Note and record the power level on the test record.

Output Power Variation

7. On the power meter, press [dB REF].

8. On the sweep oscillator/RF plug-in:

Slowly tune the FREQUENCY/TIME control through the entire frequency range to locate the point of maximum power deviation. Note and record the maximum power deviation on the test record.

9. On the power meter, press [dBm].

NOTE: If any readings exceed the specification, repeat the test using the exact CAL FACTOR information listed on the power sensor and the calibration data provided for the attenuator. By using this information you can reduce the measurement uncertainty to ± 0.5 dB.

Power Level Accuracy

10. On the sweep oscillator/RF plug-in:

Set the power level for +10 dBm.

11. Slowly tune the FREQUENCY/TIME control through the entire frequency range and note the maximum power level variations above and below the displayed power level setting. Record these readings on the test record.

4-2. Output Amplitude Test (Cont'd)

12. Press **[POWER LEVEL] [STEP SIZE] [2] [dBm]**. Use the step down [**▼**] key to step the power down 2 dB.
13. Repeat steps 11 and 12 to check the power level accuracy over the full calibrated range (down to -1 dBm) and record the data on the test record.

Power Sweep Range

14. Press the following keys on the sweep oscillator/RF plug-in:

[SHIFT] [CW] [2] [6] [.] [5] [GHz]
[TIME] [1] [0] [sec]
[POWER SWEEP]

15. Adjust the power sweep for maximum leveled power (UNLEVELED light off). Observe the power meter display to verify a power sweep from at least -1dBm to +10 dBm. Record the power meter level change on the test record.
16. Press **[POWER SWEEP]** to turn the power sweep function off.

4-3. Frequency Stability Test

SPECIFICATION

Stability (CW mode)

With 10 dB Power Level Change: ± 1 MHz
With 3:1 Load SWR: ± 500 kHz

DESCRIPTION

A frequency counter is used to check frequency change due to output power level changes and load impedance changes.

EQUIPMENT

Sweep Oscillator Mainframe	HP 8350
Frequency Counter	HP 5343A
3 dB Attenuator	HP 8493C Option 003
10 dB Attenuator	HP 8493C Option 010
Sliding Short	HP 11565A
16 dB Coupler	HP Part No. 0955-0125
Adapter WR42 to 3.5 mm (f)	HP K281C

PROCEDURE

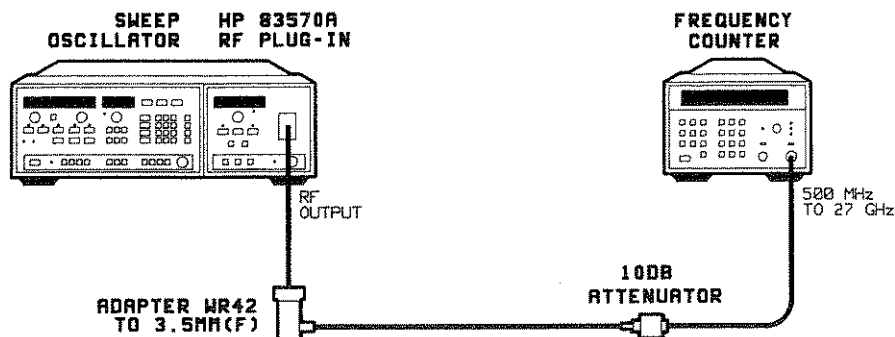

Figure 4-3. Frequency Change with 10 dB Power Level Change

Frequency Change with 10 dB Power Level Change

1. Connect the equipment as shown in Figure 4-3. Turn on the equipment and press [INSTR PRE-SET] on the sweep oscillator/RF plug-in. Allow one hour warm-up.

4-3. Frequency Stability Test (Cont'd)

2. On the sweep oscillator/RF plug-in, press [CW] [1] [8] [GHz] [POWER LEVEL] [0] [dBm].
3. On the frequency counter, rotate the SAMPLE RATE knob to HOLD. Press [SET] [OFS MHz] [Blue Key]. Then rotate the frequency counter SAMPLE RATE knob counterclockwise back to the normal position. Note the reading on the frequency counter.
4. On the sweep oscillator/RF plug-in, press [POWER LEVEL] [1] [0] [dBm].
5. Verify that frequency change is less than that given in Table 4-4. Record the reading on the test record. Reset the RF plug-in output power to 0 dBm.
6. Repeat steps 2 through 5 for the remaining frequencies listed in Table 4-4.

Table 4-4. Frequency Change with Power Level Change

CW Frequency	Frequency Change
18.0 GHz	± 1 MHz
22.2 GHz	± 1 MHz
26.0 GHz	± 1 MHz

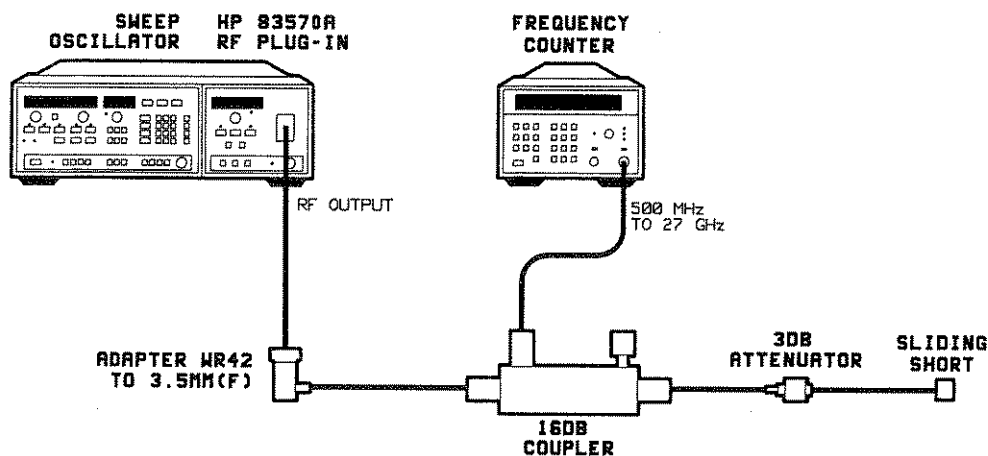

Figure 4-4. Frequency Change with 3:1 Load SWR Test Setup

4-3. Frequency Stability Test (Cont'd)

Frequency Change with 3:1 Load SWR

7. Connect the equipment as shown in Figure 4-4.
8. On the sweep oscillator/RF plug-in:
Press [INSTR PRESET] [CW] [1] [8] [GHz].
Press [POWER LEVEL] [6] [dBm].
9. On the frequency counter:
Rotate the SAMPLE RATE knob to HOLD.
Press [SET] [OFS MHz] [Blue Key].
Rotate the frequency counter SAMPLE RATE knob counterclockwise, to its original position.
10. Move the adjustable short through its range and observe the frequency counter for the greatest plus and minus frequency change. Check that the peak-to-peak change is no greater than that listed in Table 4-5. Record the results on the test record.
11. Repeat steps 8 through 10 for remaining frequencies listed in Table 4-5.

Table 4-5. Frequency Change with 3:1 Load SWR

CW Frequency	Frequency Change
18.0 GHz	± 500 kHz
22.2 GHz	± 500 kHz
26.0 GHz	± 500 kHz

4-4. Residual FM Test

SPECIFICATION

0.02 to 15 kHz Bandwidth, CW mode with CW Filter on: < 30 kHz Peak

DESCRIPTION

The RF output of the HP 83570A is displayed on a spectrum analyzer with direct readings using a measuring receiver.

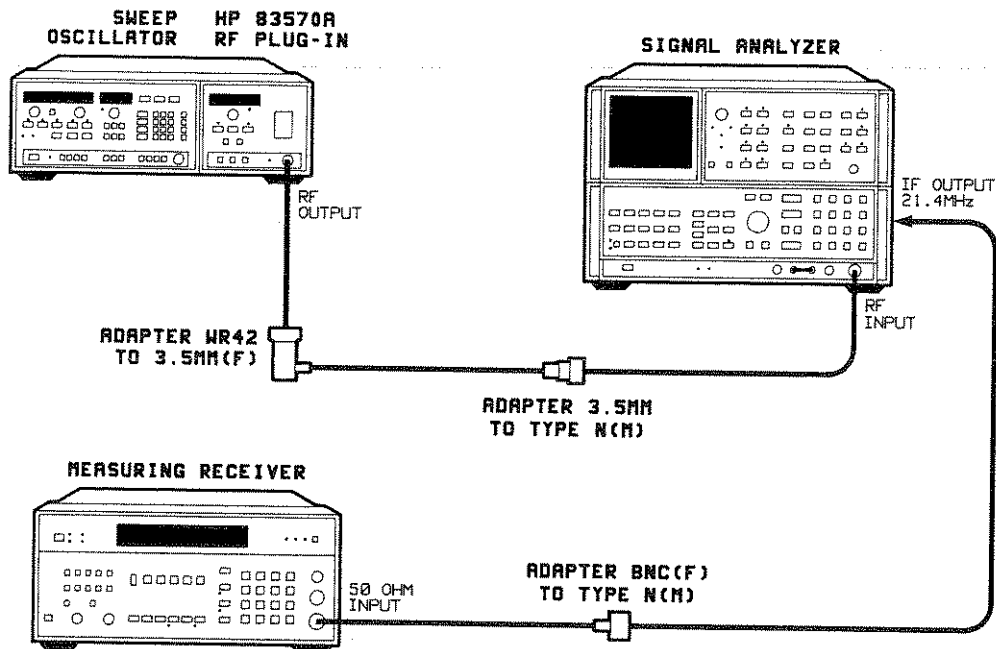

Figure 4-5. Residual FM Test Setup

EQUIPMENT

Sweep Oscillator Mainframe	HP 8350
Spectrum Analyzer	HP 8566B
Measuring Receiver	HP 8902A
Adapter WR42 to 3.5 mm (f)	HP K281C
Adapter 3.5 mm (m) to Type N (m)	HP Part No. 1250-1743
Adapter BNC (f) to Type-N (m)	HP Part No. 1250-0780

4-4. Residual FM Test (Cont'd)

PROCEDURE

1. Connect the equipment as shown in Figure 4-5. Allow at least one hour warm-up.
2. On the sweep oscillator/RF plug-in:

Press [INSTR PRESET] [CW] [2] [1] [GHz].

3. On the spectrum analyzer, press the following keys:

[INSTRUMENT PRESET]
[CENTER FREQUENCY] [2] [1] [GHz]
[PEAK SEARCH]
[MKR→REF LVL]
[RES BW] [1] [MHz]
[FREQUENCY SPAN] [5] [0] [MHz]

Use the PEAK SEARCH and MKR→CF functions as necessary to keep the signal in the center of the screen. Then press:

[FREQUENCY SPAN] [0] [GHz]

4. On the measuring receiver, press the following keys:

[INSTRUMENT PRESET]
HIGH PASS FILTER [50 Hz]
LOW PASS FILTER [15 kHz]
[FM] [AUTOMATIC OPERATION]
[PEAK +] [PEAK HOLD]

Wait 30 seconds and record the displayed residual FM on the test record.

4-4A. Alternate Residual FM Test

DESCRIPTION

Residual FM is measured on the HP 8566B using the slope detection technique. This technique uses the analyzer's IF filter skirt to slope detect the low order residual FM. The detected FM is then displayed in the time domain on the HP 8566B.

The CW RF output signal is slope-detected by using the linear portion of a spectrum analyzer resolution bandwidth filter in the zero-span mode.

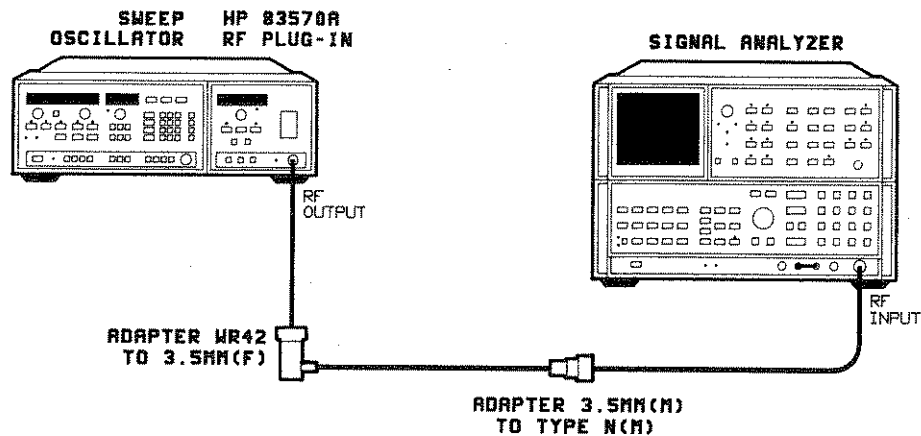

Figure 4-5A. Residual FM Test Setup

EQUIPMENT

Sweep Oscillator Mainframe	HP 8350
Spectrum Analyzer	HP 8566B
Adapter WR42 to 3.5 mm (f)	HP K281C
Adapter 3.5 mm (m) to Type N (m)	HP Part No. 1250-1743

PROCEDURE

- 1A. Connect the equipment as shown in Figure 4-5A.

4-4A. Alternate Residual FM Test (Cont'd)

- 2A. On the sweep oscillator/RF plug-in, press the following keys:

[INSTR PRESET]
[CW] [2] [1] [GHz]

- 3A. On the spectrum analyzer, press the following keys:

[INSTRUMENT PRESET]
[CENTER FREQUENCY] [2] [1] [GHz]
[FREQUENCY SPAN] [5] [0] [MHz]
[PEAK SEARCH]
[MKR→CF]
[MKR→REF LVL]
[RES BW] [1] [0] [0] [kHz]
[VIDEO BW] [1] [0] [kHz]
SCALE [LIN]

Use the PEAK SEARCH and MKR→CF functions as necessary to keep the signal in the center of the screen.

Press [FREQUENCY SPAN] and the step [▼] key to span down to 0 Hz. When 0 Hz frequency span is reached, press the following keys:

[SWEEP TIME] [1] [0] [sec]

- 4A. Press [CENTER FREQUENCY] and use the Rotary Pulse Generator (RPG) control to keep the signal between the 5th and 8th division from bottom screen. Refer to Figure 4-6.

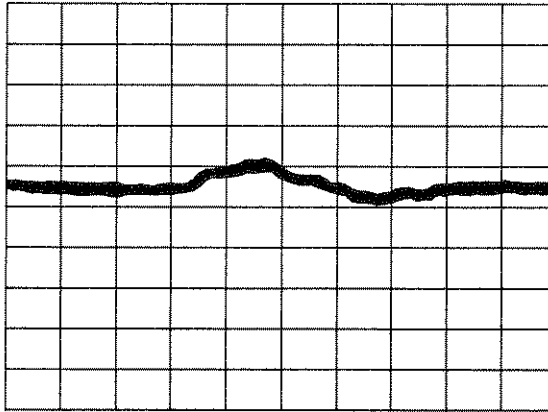

Figure 4-6. Residual FM Check

- 5A. Note the maximum peak-to-peak deviation to verify the residual FM is within tolerance and record the data on the test record.

NOTE: The vertical sensitivity (in the 5th and 8th graticules only) is 11.1 kHz/div.

4-5. Spurious Signal Test

SPECIFICATION (below the fundamental at specified maximum leveled power; 20° to 30°C.)

Harmonics: ≥ 25 dBc

Non-Harmonics: ≥ 50 dBc

DESCRIPTION

The RF output signal from the sweep oscillator is displayed on a spectrum analyzer to verify that harmonic and non-harmonic spurious signals are at or below the specified level.

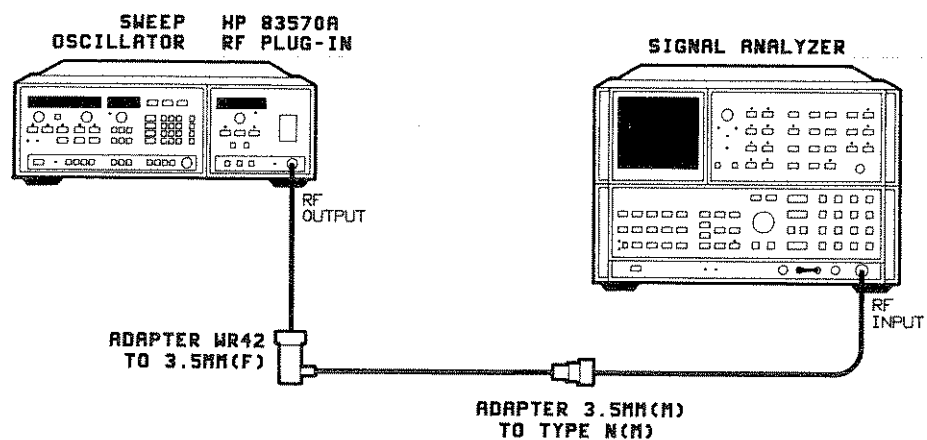

Figure 4-7. Spurious Signals Test Setup

EQUIPMENT

Sweep Oscillator Mainframe	HP 8350
Spectrum Analyzer	HP 8566B
Adapter WR42 to 3.5 mm (f)	HP K281C
Adapter 3.5 mm (m) to Type N (m)	HP Part No. 1250-1743

PROCEDURE

1. Connect the equipment as shown in Figure 4-7 and allow at least one hour warm-up.
2. On the spectrum analyzer, press the following keys:

[INSTR PRESET]
[ATTEN] [3] [0] [+dBm]
[REFERENCE LEVEL] [2] [0] [+dBm].

4-5. Spurious Signal Test (Cont'd)

3. On the sweep oscillator/RF plug-in:

Press [INSTR PRESET] [CW] [1] [8] [GHz]. Check that CW Filter is on (light on).

4. On the sweep oscillator/RF plug-in, adjust the CW control through the entire RF plug-in frequency range and check for harmonic and non-harmonic spurious signals. Record the data on the test record.

NOTE: The spectrum analyzer originates some mixing products that may appear on the display. If a signal is in question, increase the spectrum analyzer input attenuation by 10 dB and note if the signal decreases in amplitude by 10 dB. Return the attenuation to the original position. If the signal in question comes from an external source, it will change by 10 dB as the attenuation is increased. If the signal in question originates in the spectrum analyzer, the signal level will change by greater or less than 10 dB, or it will not change at all.

Rotating the HP 8350 CW control can generate noise spikes. These signals should disappear when you stop rotating the CW control.

If you find a spurious signal that appears out of specifications, first ensure that the fundamental signal amplitude is at the maximum specified power level, then check the spurious level by substituting a known amplitude signal on the spectrum analyzer.

4-6. External Frequency Modulation Test

SPECIFICATION

Maximum Deviation

0 to 100 Hz:	± 75 MHz
100 Hz to 1 MHz:	± 7 MHz
1 MHz to 2 MHz:	± 5 MHz
2 MHz to 10 MHz:	± 1.0 MHz

DESCRIPTION

The RF output is modulated with a 100 Hz, 1 MHz, 2 MHz, and a 10 MHz external signal. The 100 Hz deviation is measured directly on a spectrum analyzer. The deviation at higher frequencies is measured using a delay line discriminator and an oscilloscope to observe an increase in the modulation until distortion occurs. The frequency change is measured on a frequency counter.

EQUIPMENT

Sweep Oscillator Mainframe	HP 8350
Spectrum Analyzer	HP 8566B
Oscilloscope	HP 1741A
Frequency Counter	HP 5343A
Function Generator/Synthesizer	HP 3325A
10 dB Attenuator	HP 8493C Option 010
Power Splitter	HP 11667B
Delay Line Discriminator	See Figure 1-3
Adapter Type-N (f) to BNC (f)	HP Part No. 1250-1536
Adapter WR42 to 3.5 mm (f)	HP Part No. K281C
Adapter 3.5 mm (m) to Type N (m)	HP Part No. 1250-1743
BNC Tee	HP Part No. 1250-0781
Adapter 3.5 mm(m) to 3.5 mm (m)	HP Part No. 1250-1748
50 Ohm Feedthru Termination	HP 10100C

4-6. External Frequency Modulation Test (Cont'd)

PROCEDURE

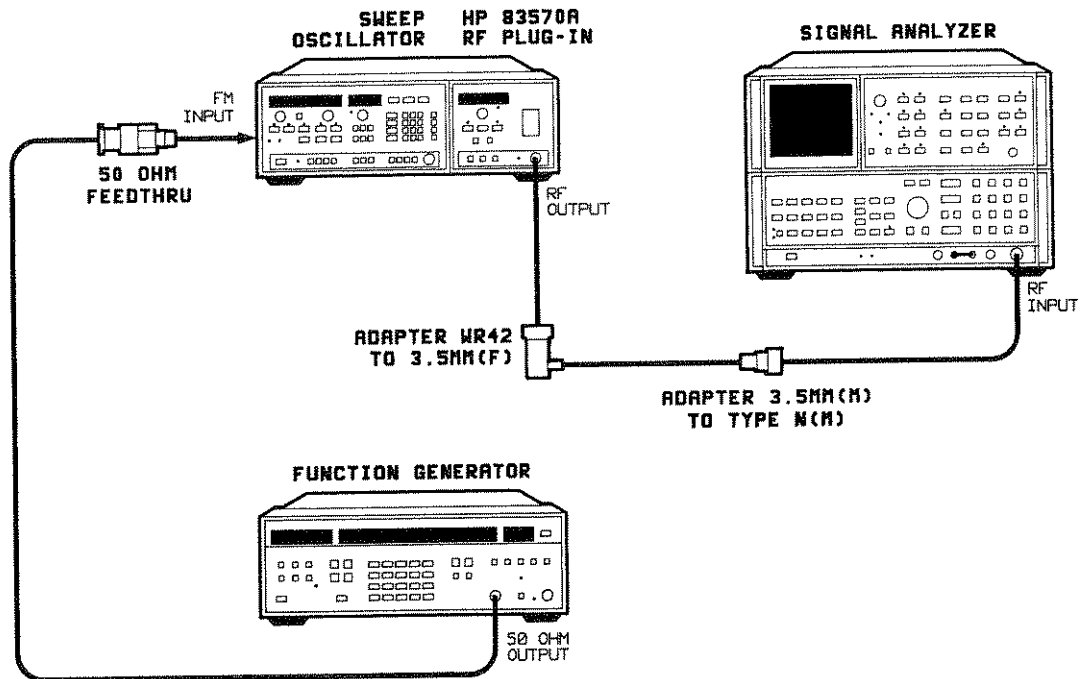

Figure 4-8. 100 Hz External Frequency Modulation Test Setup

100 Hz Modulation

1. Ensure that the RF plug-in configuration switch (A3S1) is set to -20 MHz/V, Direct Coupled FM (see Section III, Operation for details on how to set A3S1).
2. Connect the equipment as shown in Figure 4-8. Turn all instruments on and allow them to warm-up for 30 minutes.
3. On the sweep oscillator/RF plug-in:
Press [INSTR PRESET] and [CW] [2] [1] [GHz].
Press [DISPL BLANK] to turn off the display blanking.
Press [CW FILTER] to turn the filter off.

4-6. External Frequency Modulation Test (Cont'd)

- On the spectrum analyzer press:

[INSTRUMENT PRESET]
 [START FREQ] [2] [1] [GHz].
 [PEAK SEARCH] [SIGNAL TRACK] [MKR→CF]
 [FREQUENCY SPAN] [4] [0] [0] [MHz]
 [SIGNAL TRACK].

- On the function generator/synthesizer:

Set the frequency to a 100 Hz sinewave, with minimum amplitude.

Use the modify and step up keys to slowly increase the amplitude. Monitor the signal on the spectrum analyzer. Deviation from the center line should be symmetrical at first, and become non-symmetrical as deviation increases.

- Note the point at which the deviation becomes non-symmetrical and verify that the modulation is greater than ± 75 MHz from center screen. Record this reading on the test record.

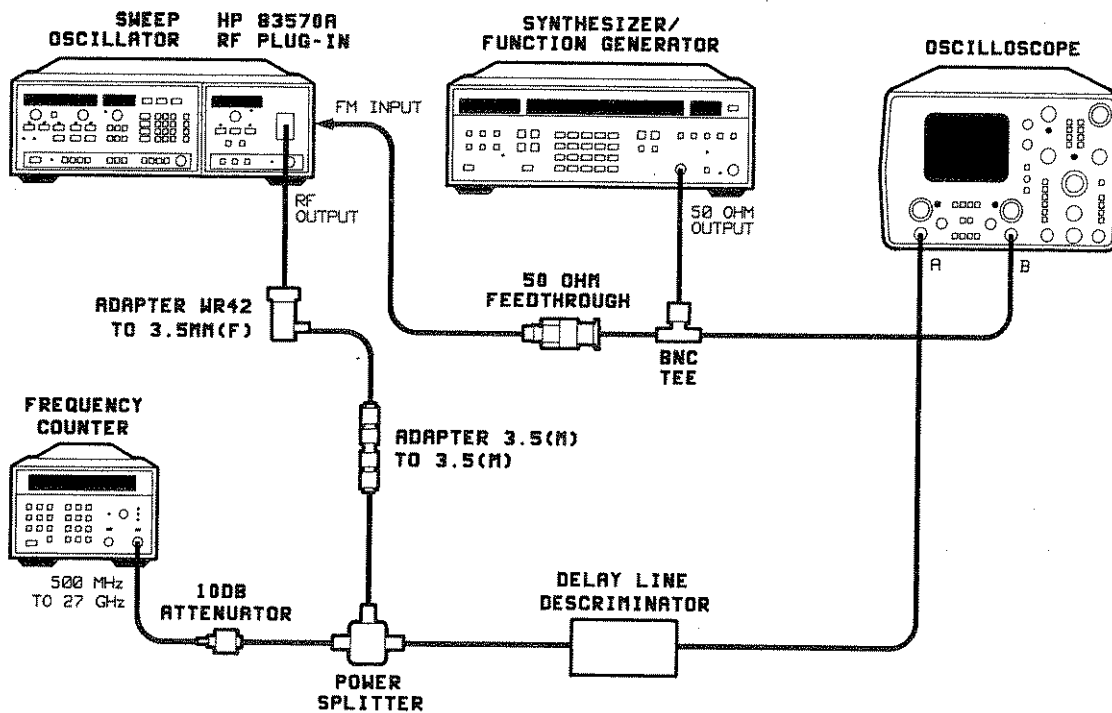

Figure 4-9. Test Setup for >100 Hz Frequency Modulation

FM Modulation >100 Hz

- Connect the equipment as shown in Figure 4-9. Do not connect the function generator/synthesizer.
- On the oscilloscope, set both inputs to 50 ohms.

4-6. External Frequency Modulation Test (Cont'd)

9. On the function generator/synthesizer, set the frequency to 1 MHz. Set the output amplitude to 0.1 volt peak-to-peak.
10. On the sweep oscillator/RF plug-in:

Press [CW] and adjust the CW VERNIER for a delay line discriminator output of 0 V, as observed on Channel A of the oscilloscope. Note the frequency counter display.
11. Connect the function generator/synthesizer output to the rear panel FM INPUT on the HP 8350, and adjust the oscilloscope (Channel A) for a clear display of the function generator/synthesizer sinewave.
12. On the function generator/synthesizer, increase the output amplitude until the deviation displayed on Channel A becomes non-symmetrical or distorted. Use the oscilloscope Channel B to monitor the function generator/synthesizer output. If the output is offset, the test is invalid.
13. On the oscilloscope, mark the positive and negative peaks of the sinewave displayed on Channel A with a grease pencil.
14. Disconnect the function generator/synthesizer from the FM INPUT on the sweep oscillator. Adjust the CW/CW VERNIER to the grease pencil marks. Note the frequency counter reading.
15. Calculate the difference between the frequency counter reading in step 10 and the reading in step 14. Verify that the difference is greater than ± 7 MHz. Record this reading on the test record.
16. Set the function generator/synthesizer to 2 MHz then 10 MHz repeating steps 12 through 15 for each frequency and record the results on the test record.

4-7. Square-Wave On/Off Ratio and Symmetry Test

SPECIFICATION

On/Off Ratio: ≥ 25 dB
Symmetry: 40/60

DESCRIPTION

The On/Off ratio is checked on the amplitude axis of a video triggered spectrum analyzer display. The symmetry is checked by calculating the On/Off ratio on the frequency axis.

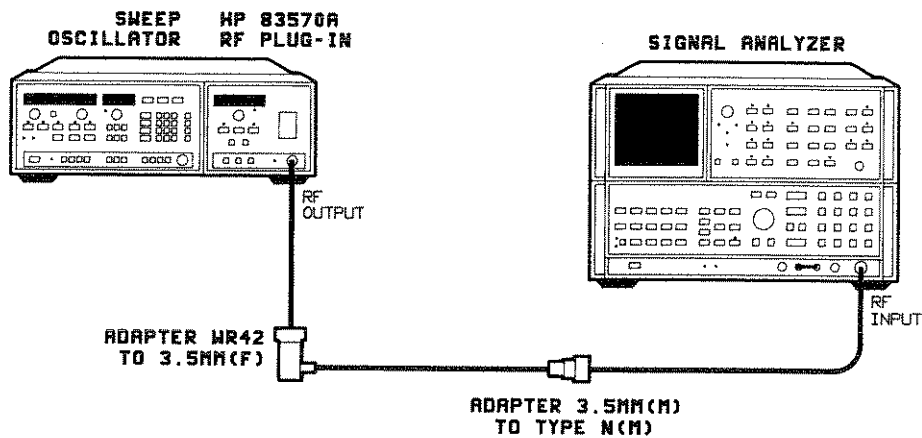

Figure 4-10. AM On/Off Ratio and Square-Wave Symmetry Test Setup

EQUIPMENT

Sweep Oscillator Mainframe	HP 8350
Spectrum Analyzer	HP 8566B
Adapter Type-N (m) to 3.5 mm (m)	HP Part No. 1250-1743
Adapter WR42 to 3.5 mm (f)	HP K281C

PROCEDURE

1. Connect the equipment as shown in Figure 4-10. Turn all instruments on and allow them to warm-up for 30 minutes.

4-7. Square-wave On/Off Ratio and Symmetry Test (Cont'd)

2. On the sweep oscillator/RF plug-in:

Press [INSTR PRESET] [CW] [2] [1] [GHz] [POWER LEVEL] [0] [dBm].

Press [MOD] to turn square-wave modulation on (light on).

3. On the spectrum analyzer, press the following keys:

[CENTER FREQUENCY] [2] [1] [GHz]

[PEAK SEARCH]

[MKR→REF LVL]

[SIGNAL TRACK]

[RES BW] verify or set [3] [MHz]

[FREQUENCY SPAN] [5] [0] [MHz]

[ZOOM]

[FREQUENCY SPAN] [0] [GHz]

[SIGNAL TRACK]

TRIGGER [VIDEO]

For 1 kHz: SWEEP [TIME] [.] [5] [μ sec].

For 27.8 kHz: [SWEEP TIME] [5] [0] [μ sec]

4. On the spectrum analyzer, adjust the reference level, if necessary, to set the signal to the top of the display. Adjust the video trigger LEVEL for a stable signal. Verify that the On/Off ratio (peak-to-peak signal variation) is greater than the value given on the test record.
5. Verify that the square-wave symmetry is between 40 and 60 percent. Record the data on the test record.

Table 4-6. Performance Test Record (1 of 2)

		Tested by _____			
Serial No. _____		Date _____			
Humidity* _____		Temperature* _____			
(*optional)					
SPECIFICATIONS TESTED Limits	Step	TEST Conditions	LOWER LIMIT	MEASURED VALUE	UPPER LIMIT
4-1. FREQUENCY RANGE AND ACCURACY					
Frequency Range	3.	Start Frequency = 18 GHz		_____	18.000 GHz
	4.	Stop Frequency = 26.5 GHz	26.500 GHz	_____	
CW Frequency Accuracy	5.	CW Frequency = 18.50 GHz	18.47 GHz	_____	18.53 GHz
		CW Frequency = 22.25 GHz	22.22 GHz	_____	22.28 GHz
		CW Frequency = 26.50 GHz	26.47 GHz	_____	26.53 GHz
Swept Frequency Accuracy	8.	18 GHz ± 55 MHz	17.945 GHz	_____	18.055 GHz
	9.	26.5 GHz ± 55 MHz	26.445 GHz	_____	26.555 GHz
Frequency Marker Accuracy	12.	M1 at 20 GHz	19.945 GHz	_____	20.055 GHz
		M2 at 22 GHz	21.945 GHz	_____	22.055 GHz
		M3 at 23.5 GHz	23.445 GHz	_____	23.555 GHz
		M4 at 25 GHz	24.945 GHz	_____	25.055 GHz
		M5 at 26 GHz	25.945 GHz	_____	26.055 GHz
4-1A. ALTERNATE SWEPT FREQUENCY AND MARKER ACCURACY					
Swept Frequency Accuracy	3A.	18.0 GHz ± 55 MHz	17.945 GHz	_____	18.055 GHz
	4A.	26.5 GHz ± 55 MHz	25.945 GHz	_____	26.555 GHz
Frequency Marker Accuracy	6A.	M1 at 20 GHz	19.945 GHz	_____	20.055 GHz
		M2 at 22 GHz	21.945 GHz	_____	22.055 GHz
		M3 at 23.5 GHz	23.445 GHz	_____	23.555 GHz
		M4 at 25 GHz	24.945 GHz	_____	25.055 GHz
		M5 at 26 GHz	25.945 GHz	_____	26.055 GHz
4-2. OUTPUT AMPLITUDE					
Maximum Levelled Power	6.	+10.0 dBm	+10.0 dBm	_____	
Output Power Variation	8.	±1.4 dB		_____	
Power Level Accuracy	11.	+10 dBm	+8.2 dBm	_____	+11.8 dBm
	13.	+8 dBm	+6.2 dBm	_____	+9.8 dBm
		+6 dBm	+4.2 dBm	_____	+7.8 dBm
		+4 dBm	+2.2 dBm	_____	+5.8 dBm
		+2 dBm	+ .2 dBm	_____	+3.8 dBm
		0 dBm	-1.8 dBm	_____	+1.8 dBm
		-1 dBm	-2.8 dBm	_____	+ .8 dBm

Table 4-6. Performance Test Record (2 of 2)

SPECIFICATIONS TESTED Limits	Step	TEST Conditions	LOWER LIMIT	MEASURED VALUE	UPPER LIMIT
4-2. OUTPUT AMPLITUDE (cont'd.)					
Power Sweep Range	15.	18.0 to 26.5 GHz	11 dB	_____	
4-3. FREQUENCY STABILITY					
Frequency Change with 10 dB Power Level Change	5.	18.0 GHz	17.999 GHz	_____	18.001 GHz
	6.	22.2 GHz	21.199 GHz	_____	22.201 GHz
		26.5 GHz	26.499 GHz	_____	26.501 GHz
Frequency Change with 3:1 Load SWR	10.	19.0 GHz	18.9995 GHz	_____	19.0005 GHz
	11.	22.2 GHz	22.1995 GHz	_____	22.2005 GHz
		26.0 GHz	25.9995 GHz	_____	26.0005 GHz
4-4. RESIDUAL FM	4.	0.02 to 15 kHz BW		_____	30 kHz
4-4A. ALTERNATE RESIDUAL FM	5A.	0.02 to 15 kHz BW		_____	30 kHz
4-5. SPURIOUS SIGNAL					
Harmonics	4.	18.0 to 26.5 GHz	25 dBc	_____	
Non-Harmonics		18.0 to 26.5 GHz	50 dBc	_____	
4-6. EXTERNAL FREQUENCY MODULATION					
CW at 21 GHz	6.	0 to 100 Hz	20.925 GHz	_____	21.075 GHz
	15.	100 Hz to 1 MHz	20.993 GHz	_____	21.007 GHz
	16.	1 MHz to 2 MHz	20.995 GHz	_____	21.005 GHz
		2 MHz to 10 MHz	20.999 GHz	_____	21.001 GHz
4-7. SQUARE-WAVE ON/OFF AND SYMMETRY					
CW at 21 GHz	4.	On/Off Ratio	25 dB	_____	
	5.	Symmetry	40%	_____	60%

Table 4-7. Operational Verification Test Record

HP 83570A RF PLUG-IN Serial No. _____		Tested by _____ Date _____	
	Specification	Pass	Fail
4-1. Frequency Range and Accuracy Test			
Frequency Range	18 to 26.5 GHz	_____	_____
CW Frequency Accuracy	18.5 GHz ± 30 MHz	_____	_____
	22.25 GHz ± 30 MHz	_____	_____
	26.5 GHz ± 30 MHz	_____	_____
Swept Frequency Accuracy	18.0 GHz ± 55 MHz	_____	_____
	26.5 GHz ± 55 MHz	_____	_____
Frequency Marker Accuracy			
M1 at 20 GHz	± 55 MHz	_____	_____
M2 at 22 GHz	± 55 MHz	_____	_____
M3 at 23.5 GHz	± 55 MHz	_____	_____
M4 at 25 GHz	± 55 MHz	_____	_____
M5 at 26 GHz	± 55 MHz	_____	_____
4.2 Output Amplitude Test			
Maximum Levelled Power	+ 10 dBm	_____	_____
Output Power Variation	+ 10 dBm ± 1.4 dB	_____	_____
Power Level Accuracy			
+ 10.0 dBm	± 1.8 dB	_____	_____
+ 8.0 dBm	± 1.8 dB	_____	_____
+ 6.0 dBm	± 1.8 dB	_____	_____
+ 4.0 dBm	± 1.8 dB	_____	_____
+ 2.0 dBm	± 1.8 dB	_____	_____
+ 0 dBm	± 1.8 dB	_____	_____
- 1.0 dBm	± 1.8 dB	_____	_____
Power Sweep Range			
18.0 to 26.5 GHz	+11.0 dB	_____	_____
*HP-IB			
*The HP-IB functions can be verified using the program listed in Section IV of the <i>HP 8350 Operating and Service Manual</i> .			

Section V. Adjustments

INTRODUCTION

This section provides adjustment procedures for the HP 83570A RF plug-in. These procedures should not be performed as routine maintenance but should be used after replacement of a part or component, or when performance tests show that the specifications of Table 1-1 cannot be met. Table 5-1 lists the adjustment titles with short descriptions in order of appearance. Table 5-2 lists the adjustments that must be performed after an assembly or an RF component has been replaced. Each procedure includes a test setup diagram and one or more adjustment location illustrations.

Adjustment Procedures

Adjustment procedures are given in the proper sequence to allow for interrelated adjustments.

NOTE: Allow a minimum of 30 minutes of warm-up for all equipment prior to making any adjustments. Use a **non-metallic** adjustment tool whenever necessary.

SAFETY CONSIDERATIONS

Although this instrument has been designed in accordance with international safety standards, this manual contains information, cautions, and warnings which must be followed to ensure safe operation and to retain the instrument in safe condition. Service and adjustments should be performed only by a skilled person who is aware of the hazards involved.

WARNING

Adjustments in this section are performed with power supplied to the instrument while protective covers are removed. There are voltages at points in the instrument which can, if contacted, cause personal injury. Be extremely careful. Adjustments should be performed only by a skilled person who is aware of the hazards involved. Capacitors inside the instrument may still be charged, even if the instrument has been disconnected from its source of supply.

EQUIPMENT REQUIRED

The equipment required for the adjustment procedures is listed in Table 1-4. If the test equipment recommended is not available, other equipment may be used if its performance meets the critical specifications listed in the table. The specified equipment required for each adjustment is referenced in each procedure.

Table 5-1. Adjustments

Adjustment Number and Name	Description	Potentiometer(s) Affected
5-1. VREF/Oscillator Bias	Adjusts the +8V reference voltage supply and YIG oscillator bias.	A7R60 (VREF) and A7R47 (YIG BIAS)
5-2. -10V Reference on A6 YO Driver	Adjusts the -10V reference power supply.	A6R21 (-10 V)
5-3. A6 YO Driver Board DAC Calibration	Adjusts the offset and slope DAC step sizes.	A6R11 (G), A6R30 (OFS), and A6R25 (ZRO)
5-4. Frequency Accuracy	Adjusts the frequency end points for accuracy.	A6S1 (GAIN) and A6S2 (OFFSET)
5-5. Delay Compensation	Adjusts the delay compensation for fast sweep speeds.	A7R70 (DLY SL) and A7R69 (DLY OFS)
5-6. ALC	Adjusts the main ALC amp for a rough power calibration.	A4R8 (1 HI), A4R10 (1 MD), A4R12 (1 LO), A4R15 (GAIN), A4R78 (OFS 3), A4R81 (OFS 1), and A4R82 (OFS 2)
5-7. Internal Leveled Flatness	Adjusts the frequency vs. power to maximize power output.	A5R34 (BP1), A5R36 (BP2), A5R38 (BP3), A5R40 (BP4), A5R41 (SL1), A5R42 (SL2), A5R43 (SL3), A5R44 (SL4) and A5R48 (SLP)
5-8. Power Calibration	Adjusts power calibration over power range.	A4R8 (1 HI), A4R10 (1 MD) and A4R12 (1 LO)
5-9. ALC Gain Adjustment.	Adjusts the overall gain of the ALC loop.	A4R15 (GAIN)
5-10. Power Sweep	Adjusts the output of the power sweep circuit for correct sweep.	A5R50 (PWSP)
5-11. FM Driver	Adjusts the best overall frequency response of the FM coil.	A5C14 (LO), A5R19 (FM OFFSET), A5R31, and A5R75 (HI).

Table 5-2. Related Adjustments

Assembly Required or Replaced	Related Adjustments
A1 Front Panel	None Applicable
A2 Doubler	5-7, 5-8 and 5-9
A3 Digital Interface	None Applicable
A4 ALC	5-6, 5-7, 5-8 and 5-9
A5 FM	5-7, 5-8, 5-9, 5-10 and 5-11
A6 YO Driver	5-2, 5-3 and 5-4
A7 Bias	5-1 and 5-5
A8 Motherboard	None Applicable
A9 YIG Oscillator	5-1, 5-4, 5-5, 5-7, 5-8 and 5-11

5-1. V REF/Oscillator Bias Adjustment

DESCRIPTION

The reference voltage is adjusted to +8.00 V. The Oscillator bias is adjusted in accordance with the voltage requirements noted on the label of the A9 YIG Oscillator (YO).

EQUIPMENT

Sweep Oscillator Mainframe	HP 8350
Digital Voltmeter	HP 3456A

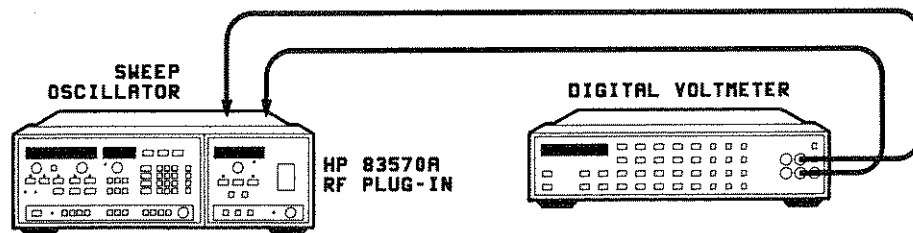

Figure 5-1. V REF/Oscillator Bias Adjustment Test Setup

PROCEDURE

1. Connect the equipment as shown in Figure 5-1. Allow the equipment to warm-up for 30 minutes.
2. Turn AC line power off. Refer to Figure 5-2 and disconnect the YO wiring harness (W5) and the Doubler wiring harness (W13). Return AC line power to the instrument.
3. Connect the DVM HI to A7TP1 and DVM LO to chassis ground. Adjust A7R60 (VREF) for a DVM indication of $8.00 \pm 0.020V$. Refer to Figure 5-3.
4. Connect the DVM HI to A7TP6. Adjust A7R47 (YIG BIAS) to the bias voltage stamped on the YO label.
5. Turn AC line power off. Reconnect wiring harnesses (W5) to the YO and (W13) to the Doubler. Return AC line power to the instrument and verify the proper voltage level at A7TP6. Readjust A7R47 if necessary.

5-1. V REF/Oscillator Bias Adjustment (Cont'd)

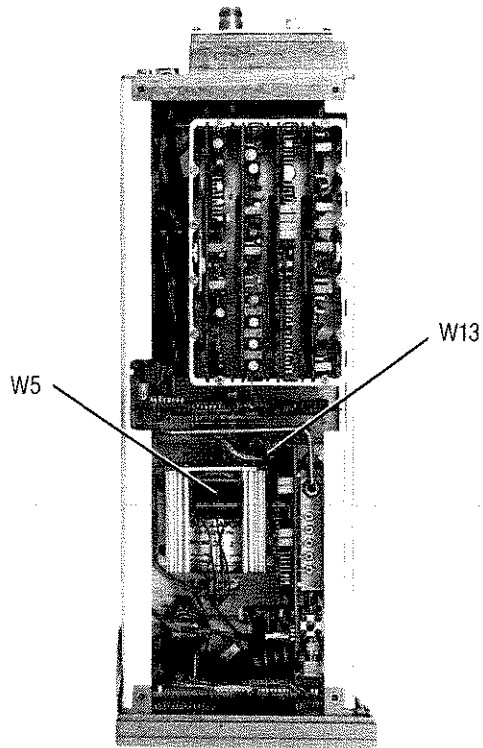

Figure 5-2. Location of YO Wiring Harnesses (W5 and W13)

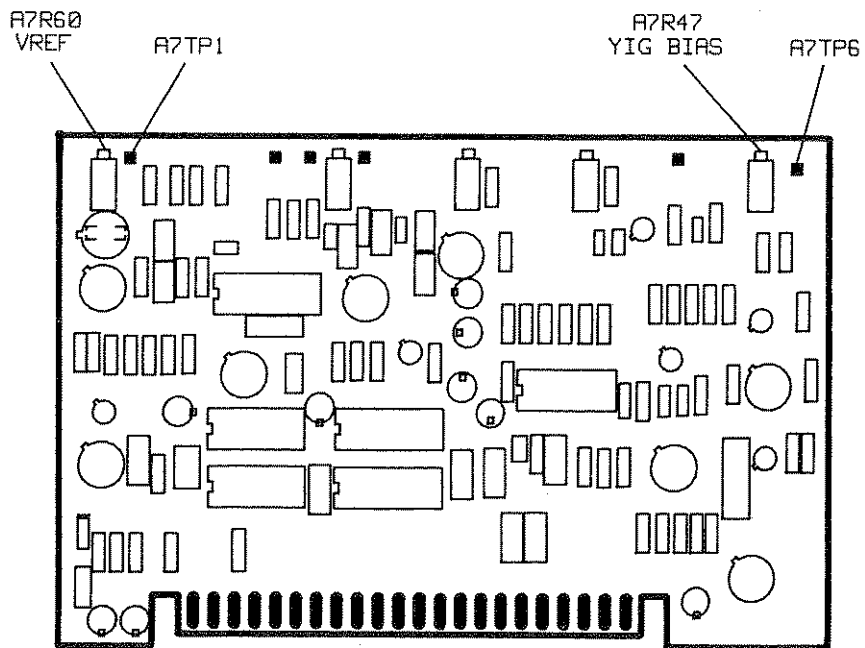

Figure 5-3. V REF/Yig Bias Adjustment Location

5-2. -10V Reference On A6 YO Driver

DESCRIPTION

The -10V REF on the A6 is used as a reference voltage for the Offset DAC also on the A6, and for the Power Level Reference DAC found on the A4 ALC assembly.

EQUIPMENT

Sweep Oscillator Mainframe HP 8350
Digital Voltmeter HP 3456A

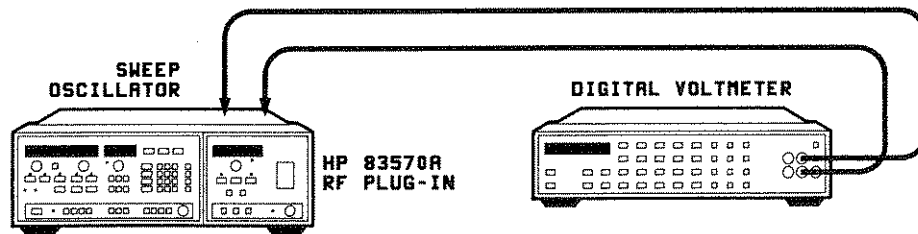

Figure 5-4. -10V Reference Adjustment Test Setup

PROCEDURE

1. Connect the equipment as shown in Figure 5-4. Allow the equipment to warm-up for 30 minutes.
2. Connect DVM HI to A6TP3. Connect DVM LO to A6TP5.
3. Adjust A6R21 (-10) for $-10.000 \pm 0.001V$. Refer to Figure 5-5.

5-2. -10V Reference On A6 YO Driver (Cont'd)

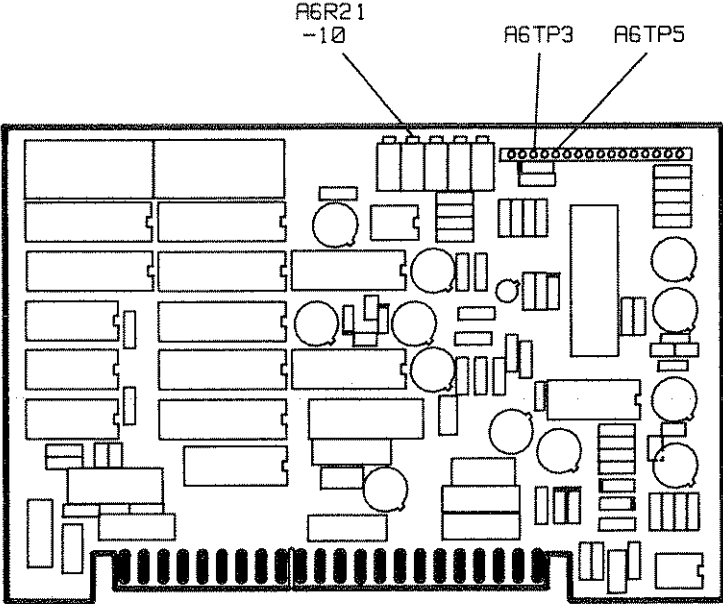

Figure 5-5. -10V Reference Adjustment Location

5-3. A6 YO Driver Board DAC Calibration

DESCRIPTION

Adjustments are made to remove offsets and to calibrate OFFSET and SLOPE DAC step sizes. The A7 Bias assembly must be removed during this procedure to eliminate a DC offset.

EQUIPMENT

Sweep Oscillator Mainframe	HP 8350
Digital Voltmeter	HP 3456A

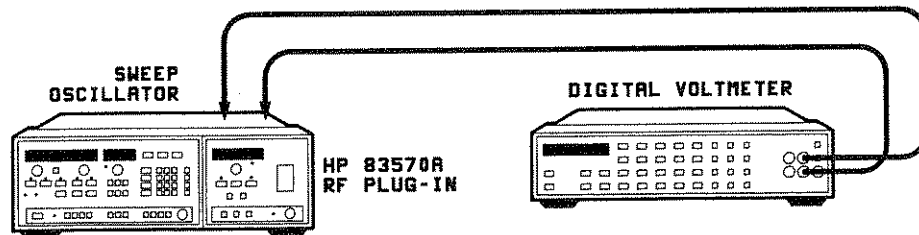

Figure 5-6. YO Driver Adjustments Test Setup

PROCEDURE

NOTE: YO Driver Board adjustments should be avoided if possible. Set up equipment as shown in Figure 5-6 and perform step 10 in Adjustment 5-4 (Frequency Accuracy) to check frequency accuracy and sweep linearity across the band. If frequencies are within ± 30 MHz tolerance, do not make these YO Driver Board adjustments.

1. Connect the equipment as shown in Figure 5-6. Allow the equipment to warm-up for 30 minutes. Turn off line power. Remove the A7 Bias assembly from the plug-in. Return power to the instrument.

5-3. YO Driver Board A6 DAC Calibration (Cont'd)

2. Float ground on DVM and connect DVM LO to A6TP13 (+ 20V FREQ REF). Connect DVM HI to A6TP16 (COLLECTOR). Refer to Figure 5-7.

3. On the sweep oscillator/RF plug-in:

Press [CW] [2] [6] [.] [5] [GHz].

Press the following keys:

[SHIFT] [0] [0]	Initiates Hex entry mode (See Figure 5-8)
[2] [GHz s] [8] [0]	Address location 2C80 (Displayed in the Frequency Window)
[M2]	Enables Data Input
[0] [0]	Hex Data

Press [▲] to step up to address 2C81.

Enter hex data [4] [0].

Press [▲] to step up to address 2C82.

Enter hex data [0] [0].

NOTE: SHIFT 00 selects the hex data entry mode, making key M1 function as address code entry, and key M2 as data code entry. For further description of hex programming refer to **OPERATOR INITIATED TESTS** in Section VIII (Service Section).

4. Note DVM indication. If it is not approximately equal to -6.2500 V , adjust A6R11 (G) for $-6.2500 \pm 0.001\text{V}$. Note the actual value obtained.

5. On the sweep oscillator/RF plug-in:

Enter hex data [BKSP] [BKSP] to change data at address 2C82 to FF.

Press [▼] to step down to address 2C81.

Enter hex data [4] [BKSP].

6. Adjust A6R30 (OFS) for a voltage reading of $19.247 \pm 0.001\text{V}$.

7. On the sweep oscillator/RF plug-in:

Enter hex data [0] [BKSP].

8. Adjust A6R25 (ZRO) for $-12.6218 \pm 0.001\text{V}$.

9. On the sweep oscillator/RF plug-in:

Enter hex data [GHz s] [0].

Press [▲] to step up to address 2C82.

Enter hex data [0] [0].

10. Adjust A6R11 (G) for a DVM indication of $-19.5000 \pm 0.001\text{V}$.

5-3. YO Driver Board A6 DAC Calibration (Cont'd)

11. Repeat steps 3 through 6 to ensure that a voltage reading of $19.247 \pm 0.001V$ is present.
12. Turn off line power. Reinstall A7 Bias assembly. Return power to instrument.

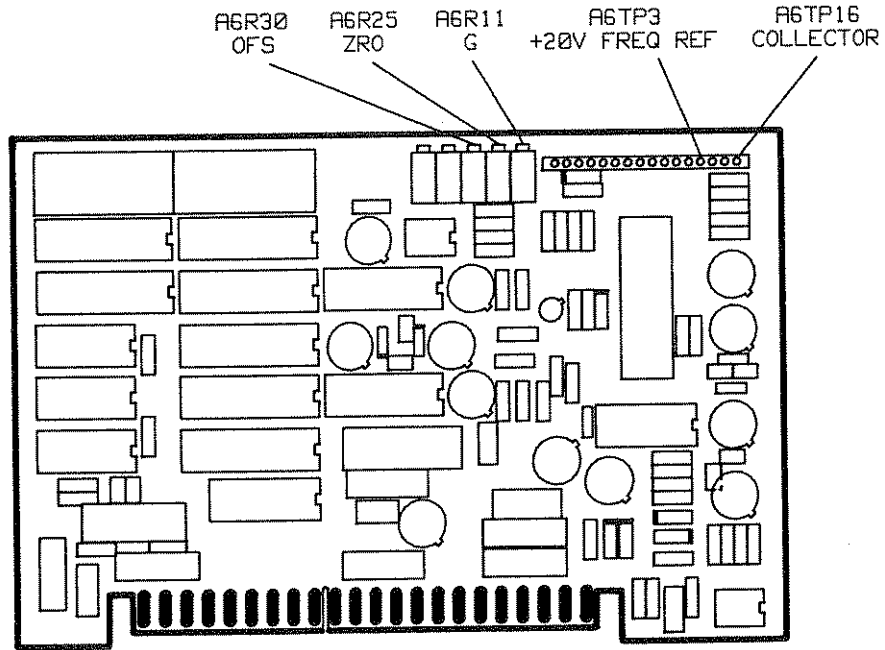

Figure 5-7. YO Driver Adjustments Location

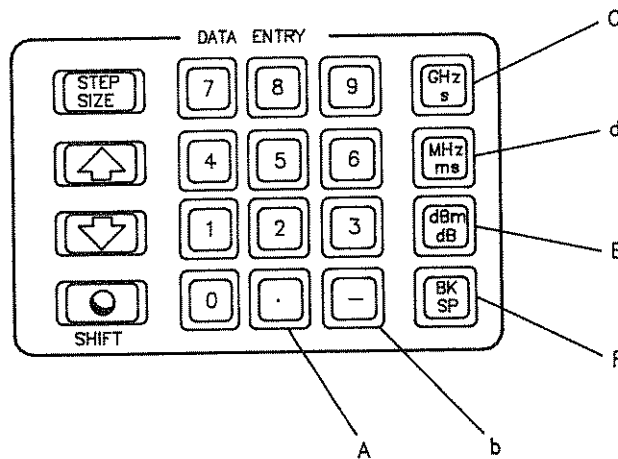

Figure 5-8. Front Panel Hexadecimal Entry Keys

5-4. Frequency Accuracy

DESCRIPTION

Frequency endpoints are adjusted using calibration modes provided through software. SHIFT 90 (low end) and SHIFT 91 (high end) initiate the frequency calibration mode in which the microprocessor reads the FREQ CAL switches on the A6 assembly and displays the byte in hexadecimal form in the POWER window. As the plug-in RPG is adjusted, the plug-in ROM reads the count, adjusts the POWER display, and updates the Offset DAC (low end) or Scaling DAC (high end) to correct the output frequency. When the external counter and 8350 front panel FREQUENCY readings match, the hex digits displayed in the POWER window indicate the proper settings for the FREQ CAL switch, A6S1 or A6S2.

EQUIPMENT

Sweep Oscillator Mainframe	HP 8350
Frequency Counter	HP 5343A
10 dB Attenuator	HP 8493C Option 010
Adapter	HP K281C

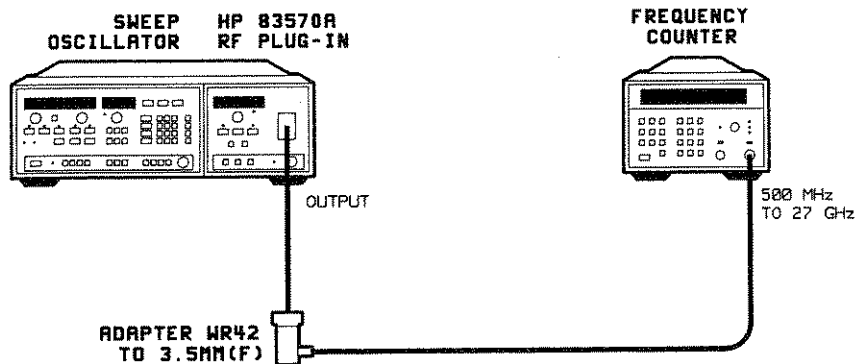

Figure 5-9. Frequency Accuracy Adjustment Test Setup

5-4. Frequency Accuracy (Cont'd)

PROCEDURE

1. Connect equipment as shown in Figure 5-9. Allow the equipment to warm-up for **ONE** hour before performing this adjustment.
2. On the sweep oscillator/RF plug-in:
 - Press [INSTR PRESET].
 - Press [CW] [1] [8] [GHz].
 - Press [SAVEn] [1].
 - Use the [▲] key to step up to 26.5 GHz.
 - Press [RECALLn] [1] and 18.000 GHz should be displayed in the FREQUENCY window.
 - Press [SHIFT] [9] [0]. This selects low end frequency calibration mode.
 - Adjust plug-in RPG for a reading of 18.000 GHz on external frequency counter.
3. Set switch A6S1 (OFFSET DAC) for the value displayed in the POWER window (See Figure 5-10 for switch location). Note the hex number for subsequent verification. Refer to the diagram in Figure 5-11.

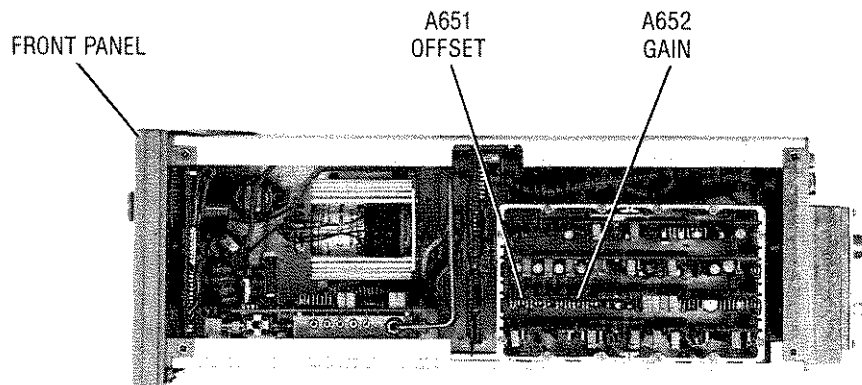

Figure 5-10. Frequency Calibration Adjustments Location

5-4. Frequency Accuracy (Cont'd)

4. On the sweep oscillator/RF plug-in:

Press **[INSTR PRESET]**, then **[RECALLn] [1]**.

5. Verify that a setting of 18.000 GHz on the 8350 produces an 18.000 GHz \pm 30 MHz indication on the external frequency counter. (If the frequency displayed does not meet specification, press **[SHIFT] [9] [0]**. The hex digits displayed in the POWER window correspond to the A6S1 switch settings. If this number does not agree with the number obtained in step 3, the switch was not set properly. Repeat the procedure.)

6. On the sweep oscillator/RF plug-in:

Press **[INSTR PRESET]**, then **[RECALLn] [1]**.

Press **[CW] [STEP SIZE] [5] [0] [0] [MHz]**.

Step up the band using the **[▲]** key until 26.500 GHz is displayed in the FREQUENCY window.

Press **[SAVEN] [2]**.

Press **[SHIFT] [9] [1]**. This selects high end frequency calibration mode.

Adjust the plug-in RPG for a reading on the external frequency counter of 26.500 GHz.

7. Set A6S2 (GAIN DAC) for the reading displayed in the POWER window (See Figure 5-10 for switch location). Note the hex number for subsequent verification. Refer to Figure 5-11.

8. On the sweep oscillator/RF plug-in:

Press **[INSTR PRESET]**, then **[RECALLn] [2]**, and repeat from step 7 as required.

9. Verify that a setting of 26.500 GHz on the 8350 produces a 26.500 GHz \pm 30 MHz indication on the external frequency counter. (If the frequency displayed does not meet specification, press **[SHIFT] [9] [1]**. The hex digits displayed in the POWER window correspond to A6S2 switch settings. If this number does not agree with the number obtained in step 6, the switch was not set properly. Repeat the procedure starting with step 6.)

10. On the sweep oscillator/RF plug-in:

Press **[CW]**. Manually adjust the RPG across the band and check for corresponding external counter readings \pm 30 MHz. Check at 20.0 GHz, 22.5 GHz, and 24.5 GHz.

5-4. Frequency Accuracy (Cont'd)

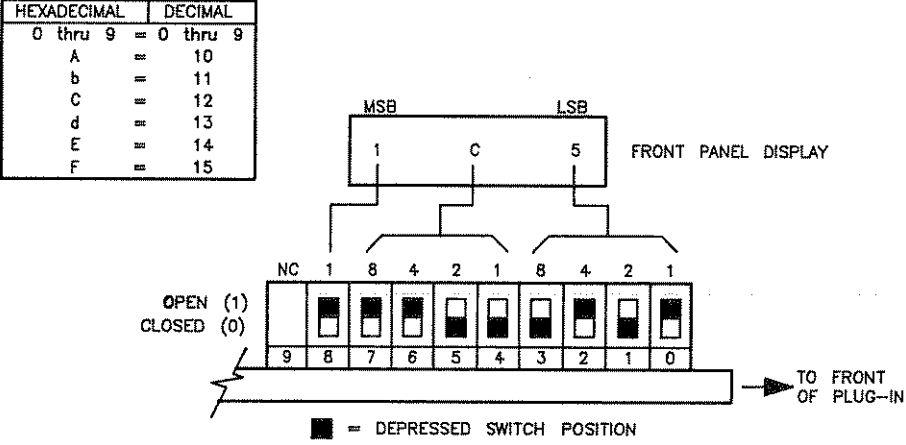

Figure 5-11. A6S1 and A6S2 Frequency Calibration Switch Configuration

5-5. Delay Compensation

DESCRIPTION

This circuit compensates for the delay in the RF sweep output that occurs at faster sweep speeds. An external frequency meter is used to generate a frequency-dependent marker which is aligned with a tuning ramp-dependent marker generated from the 8350 Sweep Oscillator. Sweep time is decreased and delay due to hysteresis in the YO is observed as the difference between the two frequency markers.

Delay compensation adjustments are made while observing the shift between frequency markers at a sweep time of 10 milliseconds (worst case). At sweep times greater than 100 milliseconds, delay should not exceed 25 MHz.

EQUIPMENT

Sweep Oscillator Mainframe	HP 8350
Oscilloscope	HP 1741A
Frequency Meter 18 to 26.5 GHz	HP K532A
Crystal Detector	HP K422A
DC Power Supply	HP 6216B

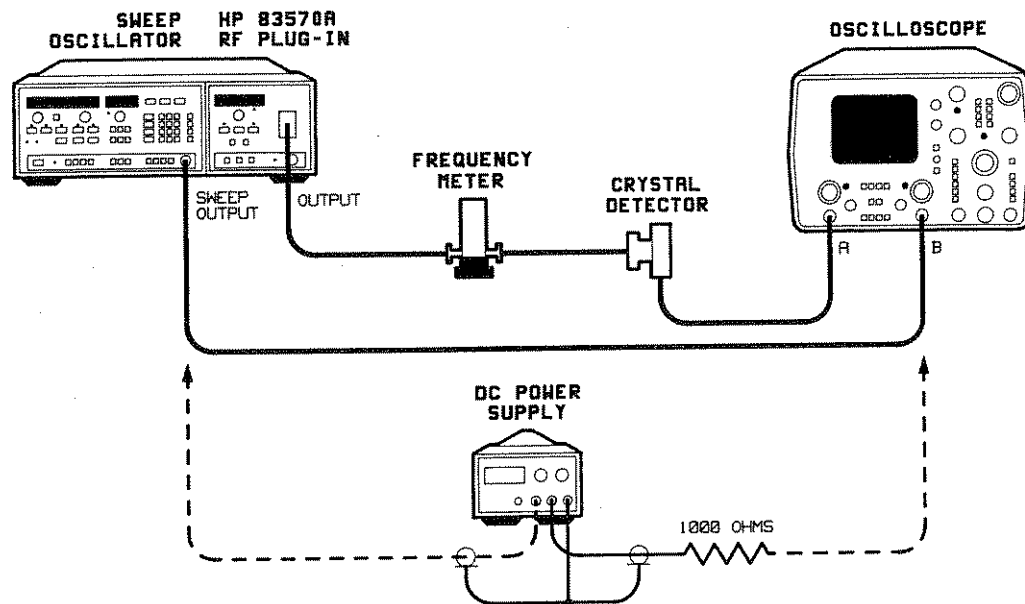

Figure 5-12. Delay Compensation Adjustment Test Setup

5-5. Delay Compensation (Cont'd)

PROCEDURE

1. Connect equipment as shown in Figure 5-12. Allow the equipment to warm-up for 30 minutes.
2. On the oscilloscope select A vs. B mode to obtain a CRT trace of amplitude versus frequency. Set Channel A to 0.5 V/DIV.
3. On the sweep oscillator/RF plug-in:
Press [INSTR PRESET] [RF BLANK].
Press [POWER LEVEL] [-] [1] [dBm].
4. Set frequency meter to 18.5 GHz. Adjust oscilloscope horizontal trace position to center marker on CRT, then set channel B to 0.1 V/DIV.
Press [TIME] [8] [0] [0] [ms] [SAVE_n] [1]
5. Adjust A7R69 (DLY OFS) for a minimum shift of the marker while changing sweep time to 10 msec. Refer to Figure 5-13.
6. Connect the power supply as shown in Figure 5-12 and adjust it to 10V.
7. Set frequency meter to 26 GHz. Adjust oscilloscope horizontal position to center marker.
8. On the sweep oscillator/RF plug-in:
Press [RECALL_n] [1].
9. Adjust A7R70 (DLY SL) for minimum shift of the marker while changing sweep time to 10 msec. Refer to Figure 5-13.
10. On the sweep oscillator/RF plug-in:
Press SWEEP [TIME] [1] [0] [0] [ms]
Press [SAVE_n] [2].
11. Adjust A7R70 (DLY SL) for minimum shift of the marker while changing sweep time to 10 msec.
12. Set the frequency meter to 18.1 GHz, then 21.6 GHz while alternating between sweep times 800 msec (RECALL_n 1) and 100 msec (RECALL_n 2). Compromise the adjustment A7R69 (OFS) to distribute the error (marker shift) so it is ≤ 25 MHz between these two frequencies. If A7R69 (DLY OFS) is adjusted, it may be necessary to readjust A7R70 (DLY SL) at 26.0 GHz.

5-5. Delay Compensation (Cont'd)

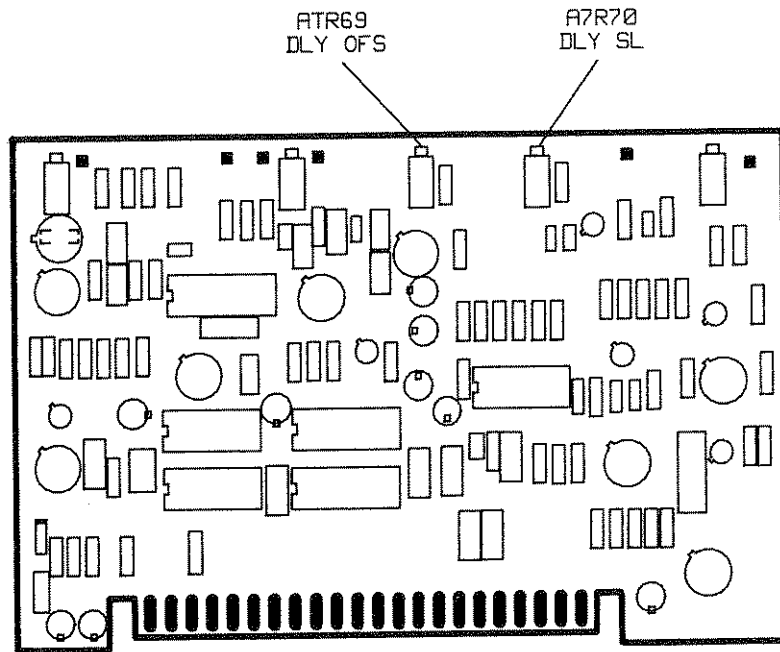

Figure 5-13. Delay Compensation Adjustment Location

5-6. ALC Adjustment

NOTE: Complete adjustment of the leveling loop requires several procedures to be performed in the order prescribed, from Adjustments 5-6 through 5-9. Deviation from this routine may cause improper leveling and/or flatness problems.

DESCRIPTION

Adjustments compensate for DC offsets in the detected RF path and the main ALC Amplifier. Power is roughly calibrated.

EQUIPMENT

Sweep Oscillator Mainframe	HP 8350
Digital Voltmeter	HP 3456A
Power Meter	HP 436A
Power Sensor	HP 8485A
Adapter	HP K281C
Extender Board	HP 08350-60031

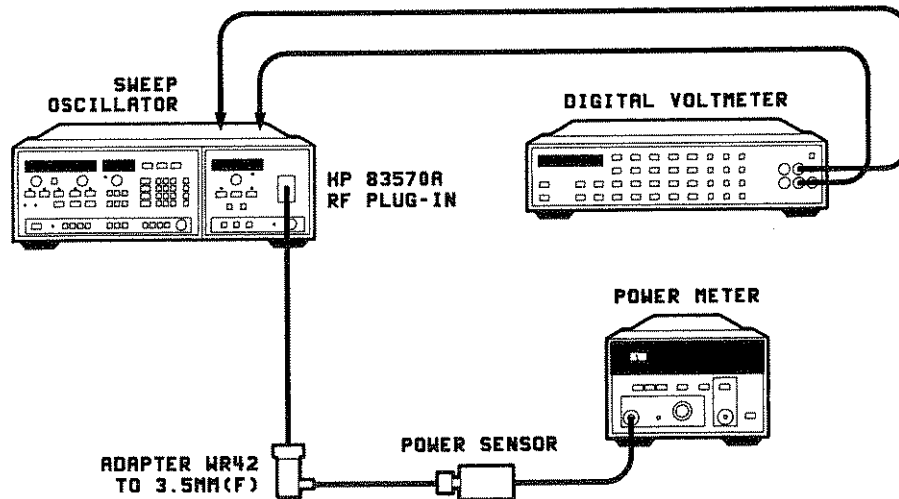

Figure 5-14. ALC Adjustment Test Setup

5-6. ALC Adjustment (Cont'd)

PROCEDURE



Turn AC power OFF when removing or installing PC boards.

1. Connect the equipment as shown in Figure 5-14. Allow the equipment to warm up for 30 minutes.
2. Turn HP 8350 AC power off and remove the A5 FM Driver board. Put the A4 assembly on an extender board.
3. On the sweep oscillator/RF plug-in:

Turn AC power on.

Press **[INSTR PRESET]**.

Sweep the full range of the plug-in at any leveled power.

4. Preset the following adjustments as indicated (Refer to figure 5-15):

A4R81 (OFS 1)	Mid-range
A4R82 (OFS 2)	Mid-range
A4R78 (OFS 3)	Mid-range
A4R15 (GAIN)	Mid-range
A4R8 (1 HI)	Fully CW

5. Float the ground on the digital voltmeter and measure the voltage between A4TP9 and A4TP10. Adjust A4R81 (OFS 1) for $0.000 \pm 0.001V$.
6. Attach jumper from A4TP11 to ground. Connect DVM LO to chassis ground. Connect DVM HI to A4TP4. Adjust A4R82 (OFS 2) for $0.000 \pm 0.001V$. Remove jumper.
7. Connect DVM HI to A4TP12 and DVM LO to A4TP9. Adjust A4R78 (OFS 3) for a DVM reading of $0.000 \pm 0.001V$.
8. Turn the HP 8350 AC power off and remove the A4 assembly from the extender board and reinsert A4 directly into the instrument.
9. Turn the HP 8350 AC power on.
10. Connect power meter sensor to RF OUTPUT as shown in Figure 5-14.

11. On the sweep oscillator/RF plug-in:

Press **[CW] [1] [8] [GHz]**.

Press **[POWER LEVEL]** and adjust rotary knob for a -1 dBm reading on the front panel display. Compensate for the calibration factor of the power sensor by checking the chart on the power sensor label and setting the CAL FACTOR % dial on the power meter accordingly.

5-6. ALC Adjustment (Cont'd)

12. Adjust A4R12 (1 LO) for a power meter reading of $-1 \text{ dBm} \pm 0.1 \text{ dB}$.
13. On the sweep oscillator/RF plug-in:

Press **[POWER LEVEL]** and adjust the rotary knob for a $+5 \text{ dBm}$ reading on the front panel display.
14. Adjust A4R10 (1 MD) for a power meter reading of $+5 \text{ dBm} \pm 0.1 \text{ dB}$.
15. Iterate steps 11 through 14 until both low and mid-power ranges are calibrated. (A4R10 and A4R12 are interactive adjustments.)
16. On the sweep oscillator/RF plug-in:

Press **[POWER LEVEL]** and adjust the rotary knob for a $+10 \text{ dBm}$ reading on the front panel display.
17. Adjust A4R8 (1 HI) for a power meter reading of $+10 \text{ dBm} \pm 0.1 \text{ dB}$. This roughly calibrates the RF power. A more accurate calibration is documented in a later procedure.
18. Turn HP 8350 AC power off and reinsert the A5 assembly directly into the instrument.
19. Turn HP 8350 AC power on.

5-6. ALC Adjustment (Cont'd)

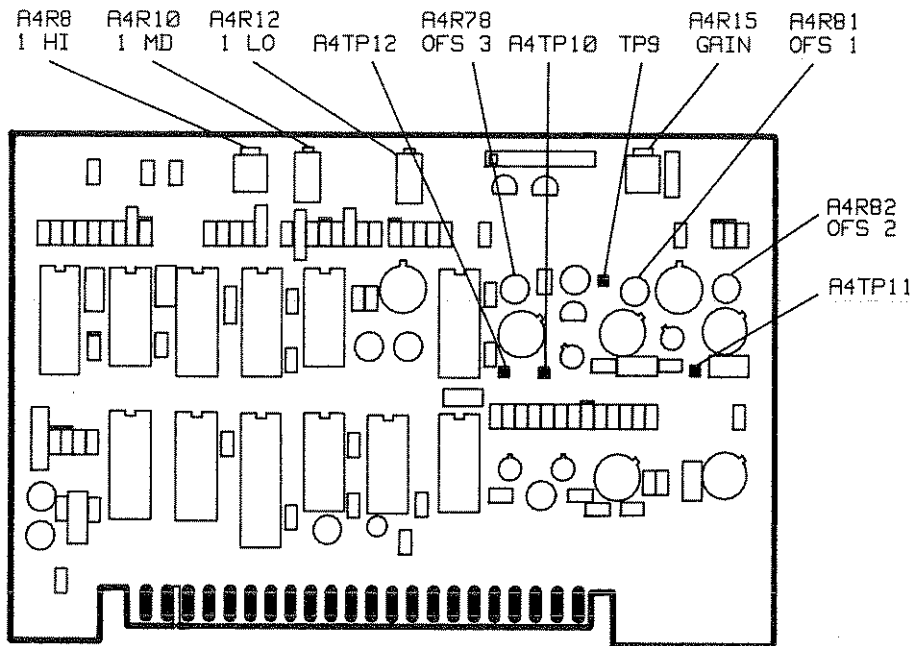

Figure 5-15. ALC Adjustment Location

5-7. Internal Levelled Flatness

NOTE: Complete adjustment of the leveling loop requires several procedures to be performed in the order prescribed, from Adjustments 5-6 through 5-9. Deviation from this routine may cause improper leveling and/or flatness problems.

DESCRIPTION

Four parallel circuits on the A5 assembly provide adjustments for ALC flatness. BP1 through BP4 and SL1 through SL4 determine the shape of the flatness compensation signal.

EQUIPMENT

Sweep Oscillator Mainframe	HP 8350
Scalar Network Analyzer	HP 8757A
Detector	HP 85025B
10 dB Attenuator	HP 8493C Option 010
Adapter	HP K281C

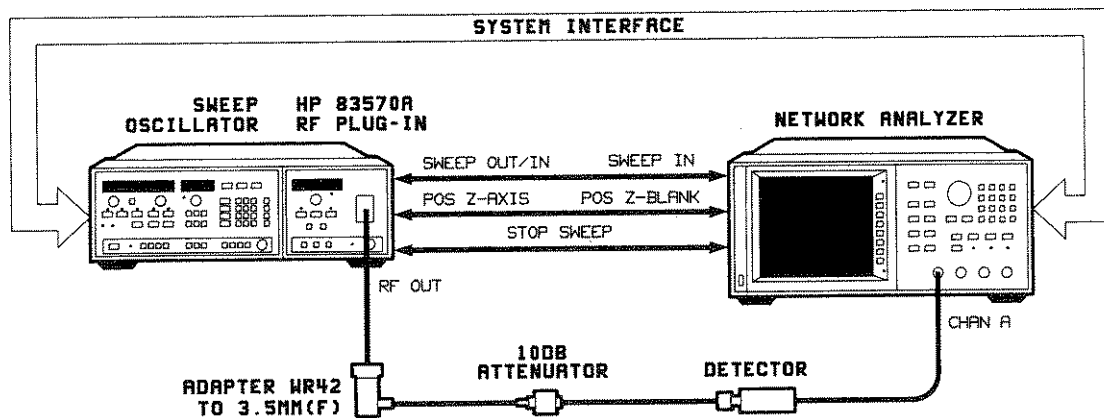

Figure 5-16. Internal Levelled Flatness Adjustment Test Setup

5-7. Internal Leveled Flatness (Cont'd)

PROCEDURE

1. Connect the equipment as shown in Figure 5-16. Allow 30 minutes for warm-up.
2. On the scalar network analyzer:
Press [PRESET]. Select [CHANNEL 2 OFF].
Press [SYSTEM]. Select [MODE DC].
Select [CAL] [DC DET ZERO] [MANUAL]. Before completing the detector zero, turn the plug-in's RF output power off.
Select [CONT].
3. On the sweep oscillator/RF plug-in:
Press [RF] to on.
After the scalar network analyzer preset, the oscillator should be in full sweep range, 18.0 to 26.5 GHz and the sweep time should be 0.2 seconds.

Preset the Adjustments

4. Set A5R34, A5R36, A5R38, and A5R40 (BP1 – BP4) fully CW. Set A5R41 through A5R44 (SL1 – SL4) to mid-range. Refer to Figure 5-17.

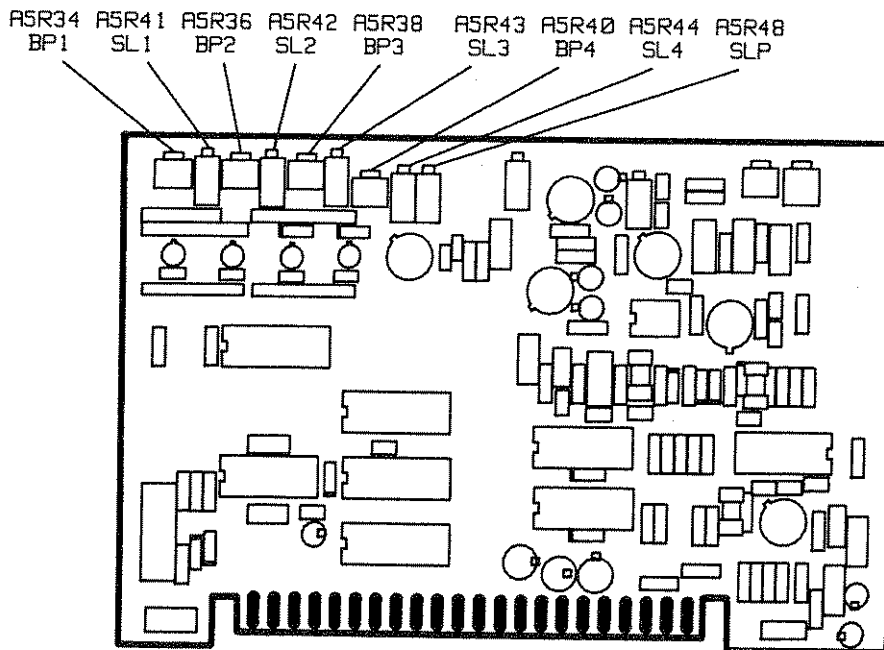

Figure 5-17. Internal Leveled Flatness Adjustment Location

5-7. Internal Levelled Flatness (Cont'd)

5. On the scalar network analyzer:

Press [SCALE] [1] [dB].

Press [REF], then select [REF LEVEL] and use the rotary knob to center the trace on the display. Adjust [REF POSN] to center the reference line. Refer to Figure 5-18.

6. On the sweep oscillator/RF plug-in:

Adjust the overall slope adjust, A5R48 (SLP), for the flattest display as shown on the scalar network analyzer. Refer to Figure 5-19.

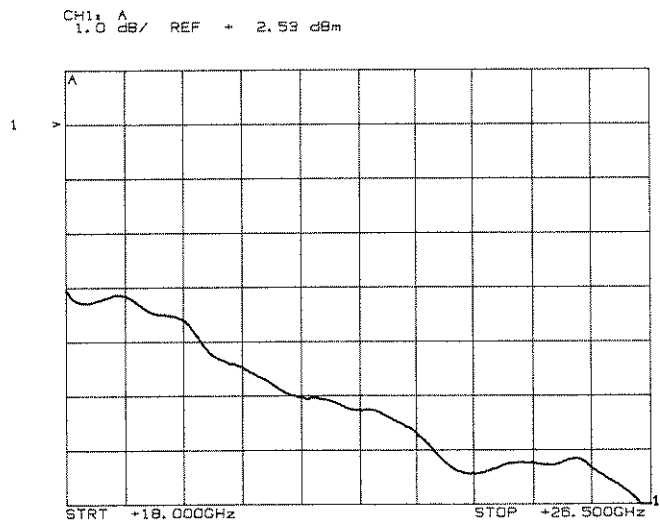

Figure 5-18. Trace Before Adjustments

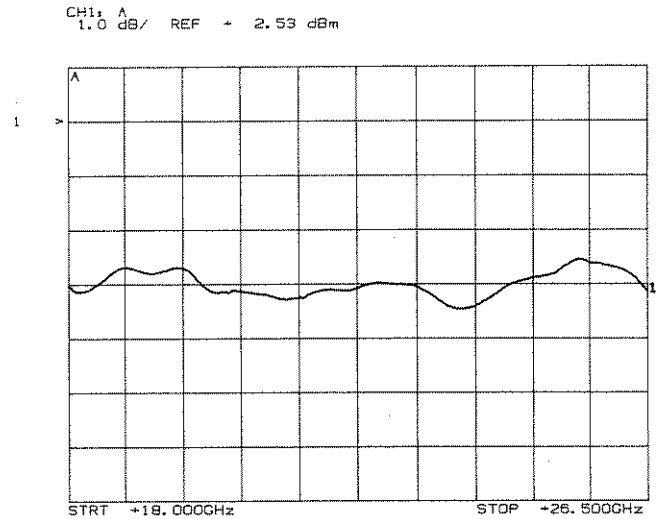

Figure 5-19. Trace After Main Slope Adjustment

7. The adjustments affect the displayed output from left to right, with A5R34 (BP1) and A5R41 (SL1) having the greatest effect. The breakpoint and slope adjustments are done in pairs. A5R34 (BP1) and A5R41 (SL1) will be adjusted before continuing to A5R36 (BP2) and A5R42 (SL2) and so on.
8. Identify the breakpoint, refer to Figure 5-20. Adjust A5R34 (BP1) so that the adjustment point lies on the breakpoint (as closely as possible).

Use the SCALE function of the scalar network analyzer to increase the displayed resolution if needed.

Adjust A5R41 (SL1) to rotate the slope and bring it closer to a flatter display, refer to Figure 5-21. Iterate between A5R34 (BP1) and A5R41 (SL1) for the flattest display.

5-7. Internal Levelled Flatness (Cont'd)

CH1: A
1.0 dB/ REF + 2.53 dBm

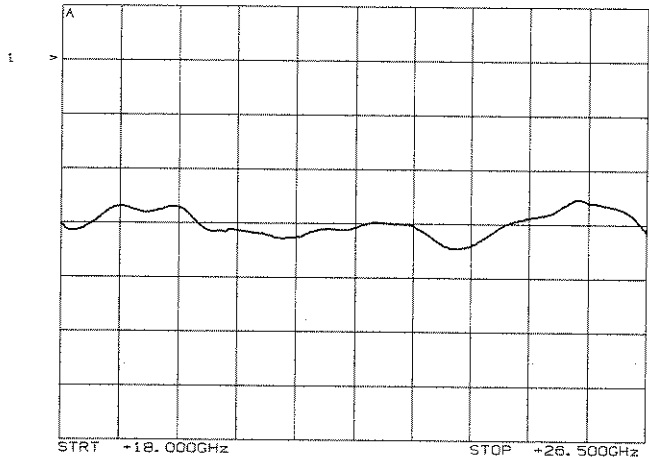

Figure 5-20. Identifying Breakpoint

CH1: A
1.0 dB/ REF + 2.53 dBm

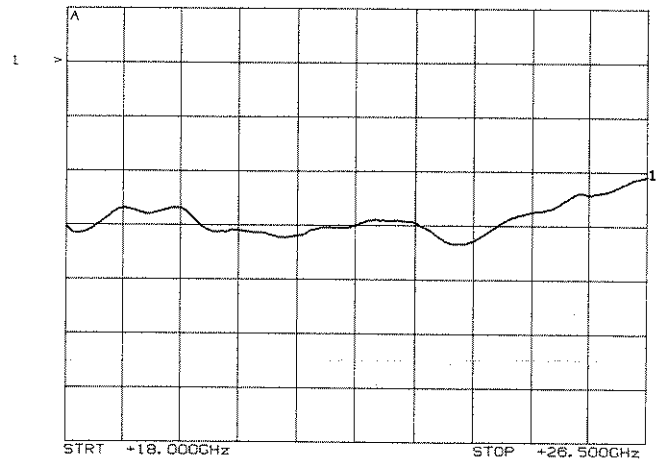

Figure 5-21. Trace After First Breakpoint and Slope Adjusted

9. Repeat step 8 for the following adjustment pairs:

A5R36 (BP2) and A5R42 (SL2)

A5R38 (BP3) and A5R43 (SL3)

A5R40 (BP4) and A5R44 (SL4)

The final properly adjusted trace should be similar to Figure 5-22. If the trace is not adjusted properly, return to the preset conditions of the potentiometers. Do not attempt to begin readjustment from the middle of the procedure.

CH1: A
1.0 dB/ REF + 2.53 dBm

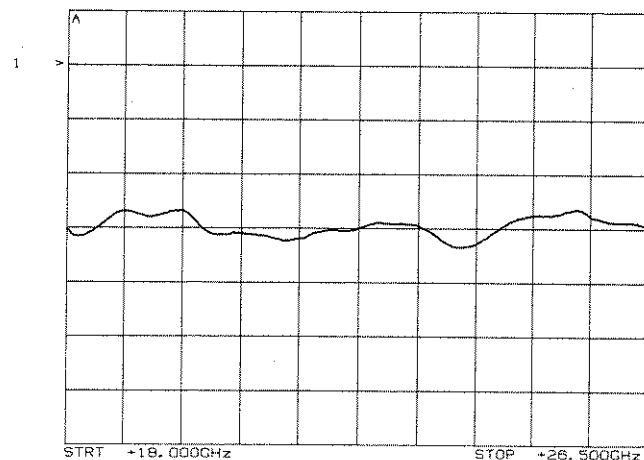

Figure 5-22. Properly Adjusted Power

5-8. Power Calibration

NOTE: Complete adjustment of the leveling loop requires several procedures to be performed in the order prescribed, from Adjustments 5-6 through 5-9. Deviation from this routine may cause improper leveling and/or flatness problems.

DESCRIPTION

Power is calibrated at a CW frequency which falls in the middle of the power variation range. Adjustments are made at three points over the leveled power range, -1 dBm, $+5$ dBm and $+10$ dBm.

EQUIPMENT

Sweep Oscillator Mainframe	HP 8350
Power Meter	HP 436A
Power Sensor	HP 8485A
Adapter	HP K281C

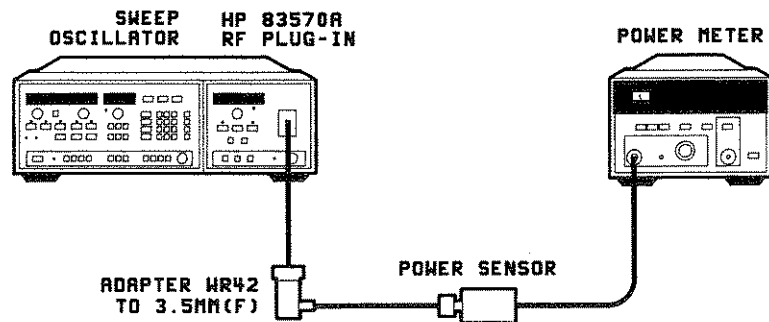

Figure 5-23. Power Calibration Adjustment Test Setup

5-8. Power Calibration (Cont'd)

PROCEDURE

1. Connect the equipment as shown in Figure 5-23. Allow 30 minutes for warm-up.
2. On the sweep oscillator/RF plug-in:
Ensure that MOD button is off.
Press **[MAN]** sweep.
Manually sweep through the band and select a frequency where the power is approximately in the center of the power variation range. Press **[CW]** at that frequency.
3. Press **[POWER LEVEL]** and adjust the rotary knob for a front panel reading of -1 dBm.
4. Adjust A4R12 (1 LO) for a power meter reading of -1 dBm ± 0.1 dB. Refer to Figure 5-24.
5. On the sweep oscillator/RF plug-in:
Press **[POWER LEVEL]** and adjust the rotary knob for a front panel reading of $+5$ dBm.
6. Adjust A4R10 (1 MD) for a power meter reading of $+5$ dBm ± 0.1 dB.
7. Recheck the -1 dBm level and readjust A4R12 if necessary.
8. On the sweep oscillator/RF plug-in:
Press **[POWER LEVEL]** and adjust the rotary knob for a front panel reading of $+10$ dBm.
Adjust A4R8 (1 HI) for a power meter reading of $+10$ dBm ± 0.1 dB.
Press **[STEP SIZE] [1] [dB]** and use the **[▲]** key to step up the power level in 1 dB steps from -1 to $+10$ dBm. The power meter reading should match the front panel power setting within ± 0.2 dB at each 1 dB step.

5-9. ALC Gain Adjustment

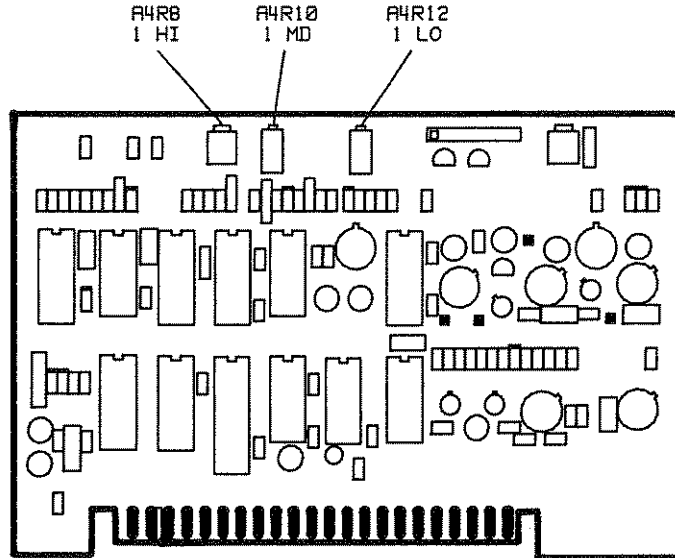

Figure 5-24. Power Calibration Adjustment Location

NOTE: Complete adjustment of the leveling loop requires several procedures to be performed in the order prescribed, from Adjustments 5-6 through 5-9. Deviation from this routine may cause improper leveling and/or flatness problems.

DESCRIPTION

A4R15 (GAIN) at the inverting input of A4U9, adjusts the gain of the main ALC amplifier. A4R15 (GAIN) is adjusted for maximum possible gain without producing ALC loop oscillations.

EQUIPMENT

Sweep Oscillator Mainframe	HP 8350
Oscilloscope	HP 1741A
Crystal Detector	HP 8473C
Function Generator	HP 3325A
Adapter	HP K281C
10 dB Attenuator	HP 8493C Option 010
50 Ohm Feedthru Termination	HP 10100C

5-9. ALC Gain Adjustment (Cont'd)

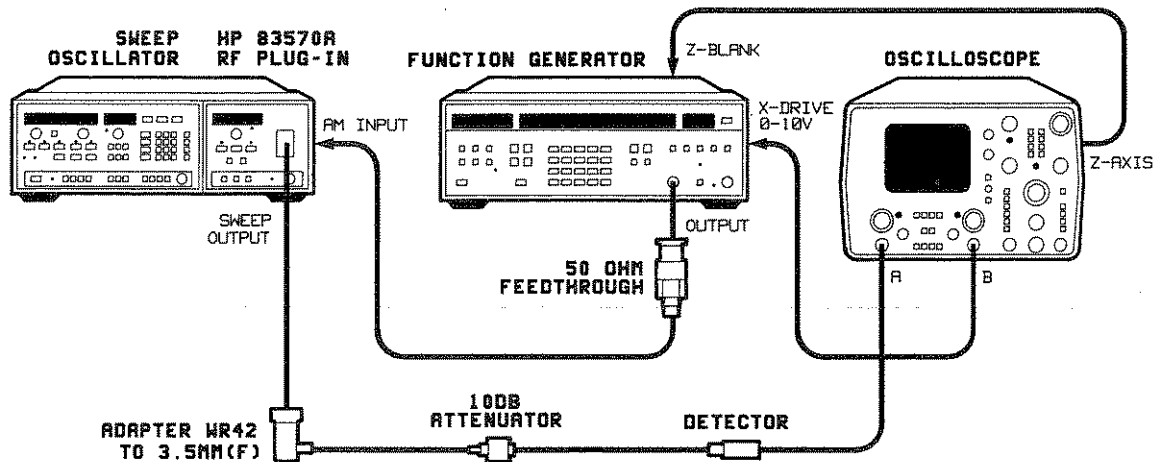

Figure 5-25. ALC Gain Adjustment Test Setup

PROCEDURE

1. Connect equipment as shown in Figure 5-25. Allow 30 minutes for warm-up.
2. On the sweep oscillator/RF plug-in:
Press **[INSTR PRESET] [CW]**.
Press **[POWER LEVEL] [1] [0] [dB]**.
3. On the oscilloscope:
Select A vs.B mode to display a frequency versus amplitude plot.
Set CHAN A for 0.05 VOLTS/DIV and AC coupling.
Set CHAN B for 1 VOLT/DIV.
Adjust horizontal POSITION and CHAN A vertical POSN controls for a stable display at mid-screen.

5-9. ALC Gain Adjustment (Cont'd)

4. Set the function generator as follows:

START FREQUENCY	100 Hz
STOP FREQUENCY	100 kHz
START CONTINUE	ON
FUNCTION	SINE
AMPLITUDE	1V p-p
OFFSET	0V
TIME	150 msec

5. Adjust the amplitude for a 4 division modulation trace on the oscilloscope.
6. Adjust A4R15 (GAIN) for a minimum variation from 4 divisions reference. The variations must be between 5.66 divisions (+3 dB) and 2.83 divisions (-3 dB) with no oscillations which appear as discontinuities in the trace. Refer to Figure 5-26.

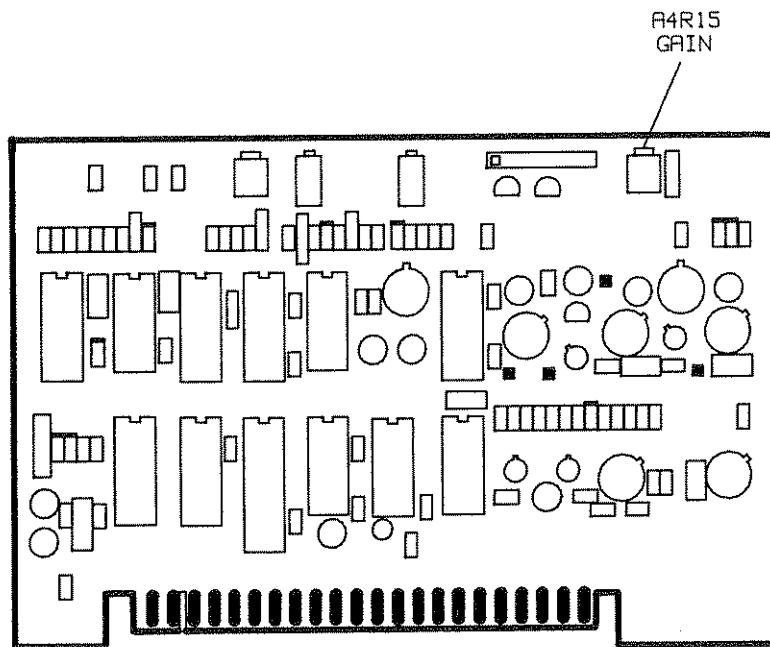

Figure 5-26. ALC Gain Adjustment Location

5-10. Power Sweep

DESCRIPTION

A 10 dB/sweep POWER SWEEP mode is selected and the result is displayed on the 8757A Scalar Network Analyzer. Output of the power sweep circuit is adjusted for the correct sweep.

EQUIPMENT

Sweep Oscillator Mainframe	HP 8350
Scalar Network Analyzer	HP 8757A
Detector	HP 85025B
10 dB Attenuator	HP 8493C Option 010
Adapter	HP K281C

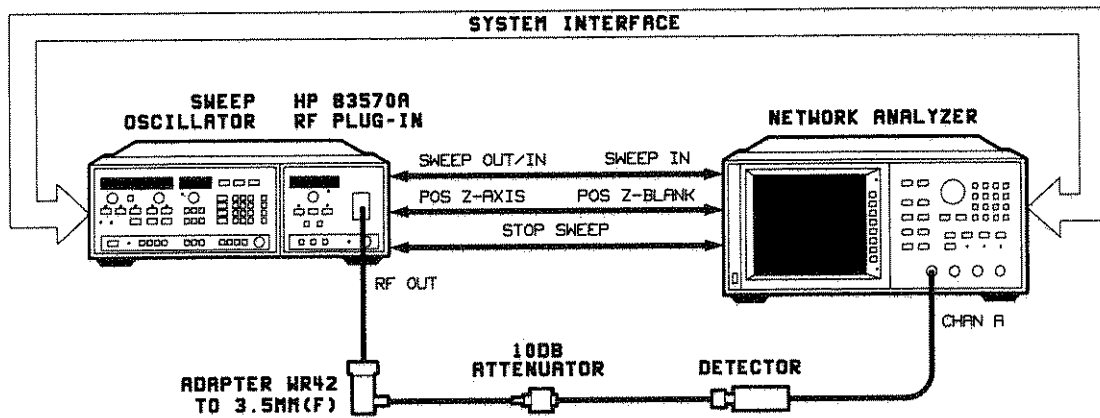

Figure 5-27. Power Sweep Adjustment Test Setup

5-10. Power Sweep (Cont'd)

PROCEDURE

1. Connect the equipment as shown in Figure 5-27. Allow 30 minutes for warm-up.
2. On the scalar network analyzer:
 - Press **[PRESET]**. Select **[CHANNEL 2 OFF]**.
 - Press **[SYSTEM]**. Select **[MODE DC]**.
 - Select **[CAL]** **[DC DET ZERO]** **[MANUAL]**. Before completing the detector zero, turn the plug-in's RF output power off.
 - Select **[CONT]**.
 - Press **[REF]**, then select **[REF POSN]**. Adjust the trace with the rotary knob to the bottom horizontal graticule.
3. On the sweep oscillator/RF plug-in:
 - Press **[RF]** to on.
 - Press **[SHIFT]** **[CW]** **[POWER LEVEL]** **[0]** **[dB]**.
4. On the scalar network analyzer:
 - Press **[SCALE]** **[5]** **[dB]**
 - Press **[REF]**, then select **[REF LEVEL]**.
 - Adjust the trace with the rotary knob to one division below the center horizontal graticule.
5. On the sweep oscillator/RF plug-in:
 - Press **[POWER SWEEP]** **[1]** **[0]** **[dB]**.
6. While observing the HP 8757A display of the POWER SWEEP output, adjust A5R50 (PWSP) (See Figure 5-28 for adjustment location) for 10 dB/sweep (two major divisions). Refer to Figure 5-29 for properly adjusted power sweep.

5-10. Power Sweep (Cont'd)

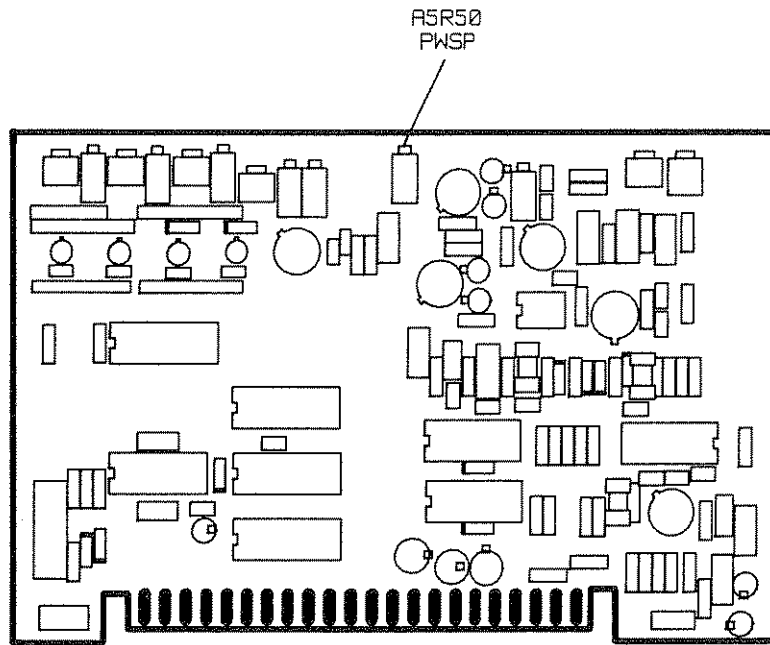

Figure 5-28. Power Sweep Adjustment Location

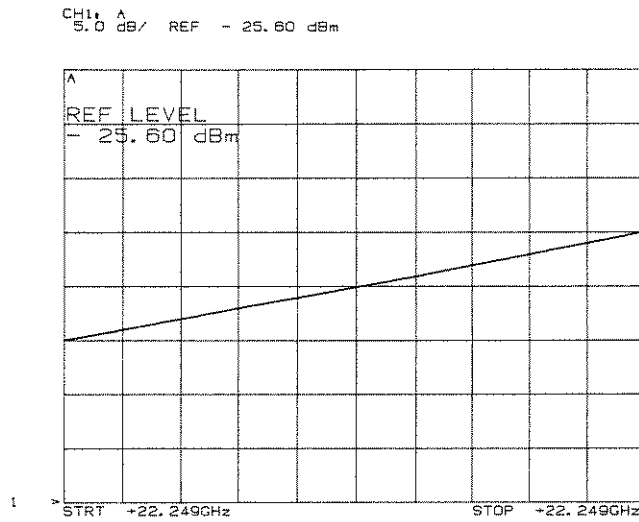

Figure 5-29. Power Sweep After Adjustment

5-11. FM Driver

DESCRIPTION

The FM Driver high frequency offset is adjusted for a zero volt drive with no FM applied. A delay-line discriminator is used to detect and display FM on an oscilloscope. Adjustments are made for best overall frequency response from 100 Hz to 10 MHz. Compliance to a specification of ± 3 dB is checked between 100 Hz and 2 MHz.

EQUIPMENT

Sweep Oscillator Mainframe	HP 8350
Digital Voltmeter	HP 3456A
Oscilloscope	HP 1741A
Function Generator	HP 3325A
Delay Line Discriminator	Refer to Figure 1-3 (General Information)
Frequency Counter	HP 5343A
Adapter	HP K281C
50 Ohm Feedthru Termination	HP 10100C

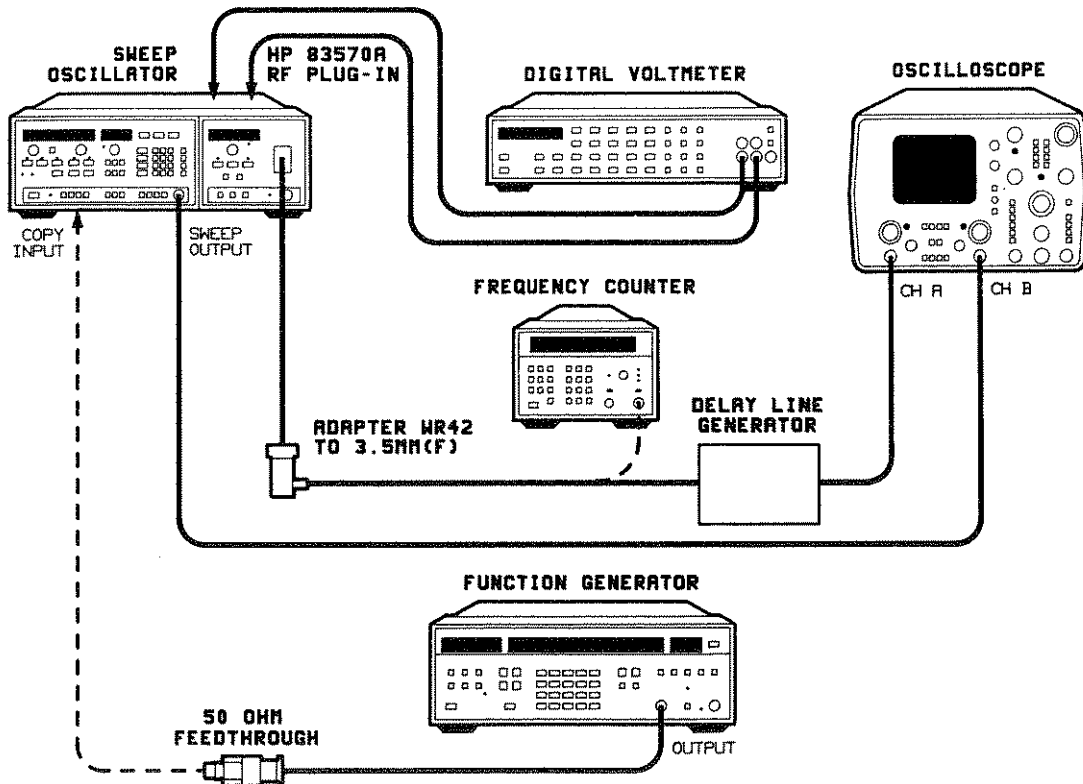

Figure 5-30. FM Adjustment Test Setup

5-11. FM Driver (Cont'd)

PROCEDURE



Turn off AC power when removing or installing PC boards.

1. The equipment in Figure 5-30 will be configured in the following procedure. In the interim, allow 30 minutes for warm-up for each instrument.

FM Offset

2. Turn the HP 8350 AC power off and place A5 FM Driver assembly on extender board.
3. Turn the HP 8350 AC power on and connect DVM HI to A5 board connector pin 21 and DVM LO to A5TP7 (Ground). Adjust A5R19 (FM OFFSET) for $0.00 \pm 0.0001V$. Refer to Figure 5-31.
4. Turn the HP 8350 AC power off and disconnect the DVM from test points. Remove the extender board, and reinstall the A5 FM Driver board in the instrument.

5. On the sweep oscillator/RF plug-in:

Turn AC power on.

Set the sweep oscillator as follows:

FREQUENCY Sweep Mode	[SHIFT] [CW]
CW FREQUENCY	Mid-band (22.25 GHz)
CW VERNIER	ON
SWEEP TRIGGER	INT
RF BLANK	OFF

Set the RF plug-in as follows:

POWER LEVEL	Any leveled power
CW FILTER	OFF
ALC MODE	INT

6. Set the oscilloscope as follows:

MODE	A vs.B
CHAN A	
INPUT	50
VOLTS/DIV	0.005
CHAN B	
INPUT	DC
VOLTS/DIV	1

5-11. FM Driver (Cont'd)

- Set the function generator as follows:

FREQUENCY 10 MHz
 FUNCTION SINE
 AMPLITUDE Adjust the amplitude for a 100 mV p-p display on the oscilloscope screen.

Flatness

- Connect the frequency counter to the HP 83570A RF OUTPUT. Apply +1V DC to the rear panel FM INPUT with the function generator. A shift in frequency of approximately -20 MHz should occur on the frequency counter. This displays a correct FM sensitivity. If a frequency shift of -6 MHz is indicated, reset switch 5 on A3S1 to 0. (Refer to Figure 3-3 for A3S1 switch configuration.)
- Connect the equipment as shown in Figure 5-30 with the delay line discriminator connected to the RF OUTPUT and the function generator connected to the rear panel FM INPUT connector.
- Set ground reference on the oscilloscope to center line. Adjust the sweep oscillator CW FREQUENCY and CW VERNIER for a waveform at the center of the oscilloscope CRT.
- Adjust CHAN A CAL (sensitivity) for a trace 4 divisions p-p, centered on the screen. (This sets up a 100% amplitude reference.)
- Sweep the function generator frequency from 100 Hz to 100 kHz. Select resistor A5R31 (See Figure 5-31) so the amplitude at 100 Hz and at 100 kHz are the same ± 0.2 divisions on the screen.

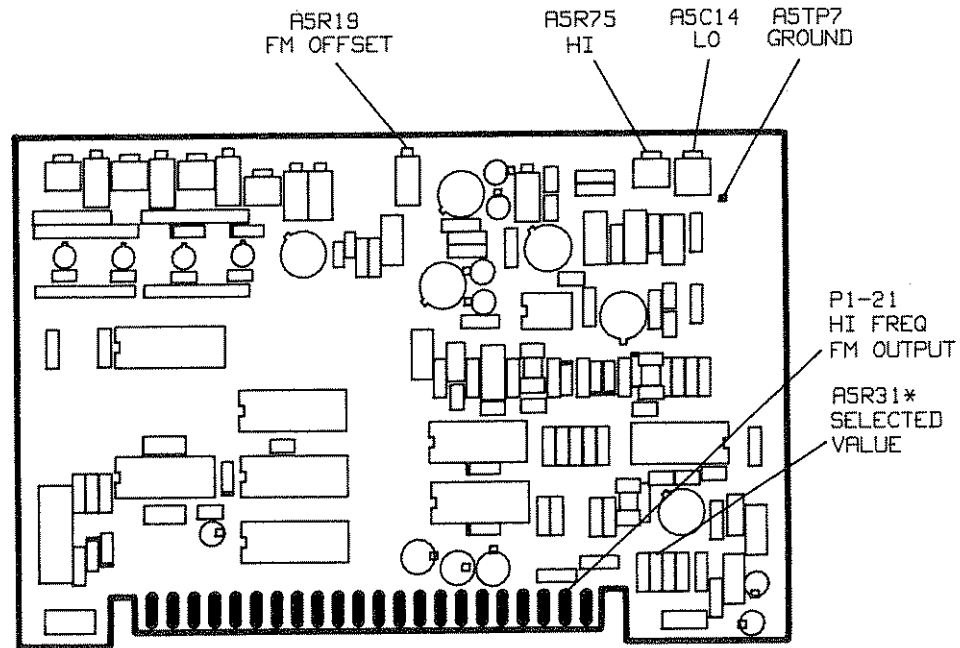

Figure 5-31. FM Driver Adjustment Location

5-11. FM Driver (Cont'd)

13. Sweep the function generator frequency from 100 Hz to 10 MHz. Iterate between adjustments A5C14 (LO) and A5R75 (HI) to obtain the most constant overall response from 100 Hz to 10 MHz.
14. Check that the +3 dB flatness specification is met between 100 Hz and 2 MHz as follows. Sweep the function generator frequency between 100 Hz and 2 MHz. On the oscilloscope, note the maximum point (+3.0 dB) can be up to 5.6 divisions, and the minimum point (-3.0 dB) which can be down to 2.8 divisions. Refer to Figure 5-32.

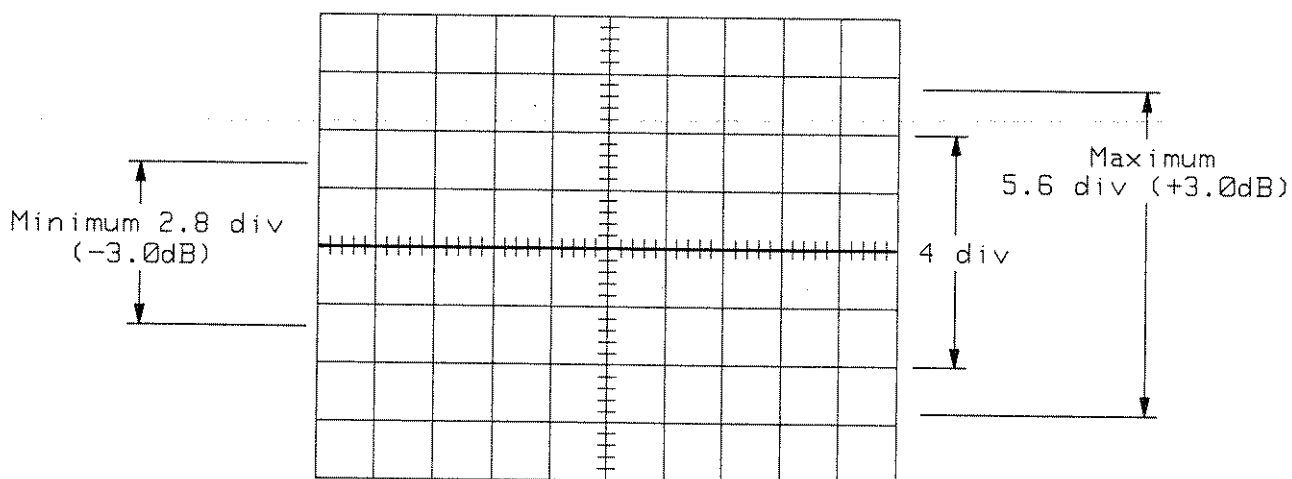

Figure 5-32. Flatness Response

15. If the flatness response in step 14 is not met, repeat steps 12 and 13 and make compromise adjustments in the 100 Hz to 2 MHz range to meet the flatness requirements.

Section VI. Replaceable Parts

INTRODUCTION

This section contains information for ordering parts. Table 6-1 lists the assemblies that are available for exchange or are under two-year warranty. Table 6-2 lists abbreviations used in the parts list and the names and addresses that correspond to the manufacturer's code numbers. Table 6-3 lists all replaceable parts in reference designator order.

TWO YEAR WARRANTY AND RESTORED EXCHANGE PARTS

A two-year warranty applies to both an original component and to one that is purchased as a replacement part either new or restored through the support life of the instrument. The restored exchange parts program allows a defective component to be exchanged for a factory-restored part that provides a substantial reduction in replacement cost. In addition, if the original component is covered by a two-year warranty, the exchanged component will also have a two-year warranty from the date of purchase. Table 6-1 identifies the components within the instrument that have a two-year warranty as well as those that are available as restored exchange parts.

ABBREVIATIONS

Table 6-2 contains three major sections:

- Reference Designations explain the designators used in the parts list.
- Abbreviations define all abbreviations used in the descriptions of replaceable parts.
- Manufacturer's Code List references the name and address of a typical manufacturer with the code number provided in the parts list.

REPLACEABLE PARTS LIST

Table 6-3 is the list of replaceable parts and is organized as follows:

- Electrical assemblies and their components in alpha-numerical order by reference designation.
- Chassis-mounted parts in alpha-numerical order by reference designation.
- Miscellaneous parts.

The information given for each part consists of the following:

- a. The Hewlett-Packard part number.
- b. Part number check digit (CD).
- c. The total quantity (Qty) in the instrument.
- d. The description of the part.
- e. A typical manufacturer of the part in a five-digit code.
- f. The manufacturer's number for the part.

The total quantity for each part is given only once — at the first appearance of the part number in the list.

ILLUSTRATIONS

Figures 6-1 (1 through 3) and 6-2 (1 through 4), Replaceable Parts, provide the location of front and back panel and exterior frame replaceable mechanical parts. These parts are numbered for reference and are listed in Table 6-3.

ORDERING INFORMATION

To order a part listed in the replaceable Parts List, quote the Hewlett-Packard part number with its check digit (CD), indicate the quantity, and address the order to the nearest Hewlett-Packard office. The check digit will ensure accurate and timely processing of your order.

To order a part that is not listed in the Replaceable Parts List, include the instrument model number, instrument serial number, description and function of the part, and the number of parts required. Address the order to the nearest Hewlett-Packard office.

SPARE PARTS KIT

Stocking spare parts for an instrument is often done to ensure quick return to service after a malfunction occurs. Hewlett-Packard has a "Spare Parts Kit" available for this purpose. The kit consists of selected replaceable assemblies and components for this instrument. The contents of the kit and the "Recommended Spares" list for this instrument may be obtained on request and the "Spares Parts Kit" may be ordered through your nearest Hewlett-Packard office.

Table 6-1. Two-Year Warranty and Restored Exchange Parts

Reference Designation	New Part Number	Rebuilt-Exchange Part Number	Description
A2	5086-7300	5086-6300	Doubler Assembly
A9	5086-7315	5086-6315	Oscillator Assembly

NOTE: For module exchange procedure, see Section VIII, Service.

Table 6-2. Reference Designations, Abbreviations, and Manufacturer's Code List (1 of 3)

REFERENCE DESIGNATIONS

A	Assembly	FL	Filter	S	Switch
AT	Attenuator, Isolator, Limiter, Termination	H	Hardware	T	Transformer
B	Fan, Motor	J	Electrical Connector (Stationary Portion), Jack	TB	Terminal Board
C	Capacitor	K	Relay	TP	Test Point
CP	Coupler	L	Coil, Inductor	U	Integrated Circuit, Microcircuit
CR	Diode, Diode Thyristor, Step Recovery Diode (SCR), Varactor	M	Meter	V	Electron Tube
DC	Directional Coupler	MP	Miscellaneous Mechanical Part	VR	Breakdown Diode (Zener), Voltage Regulator
DS	Annunciator, Lamp, Light Emitting Diode (LED), Signaling Device (Audible or Visible)	P	Electrical Connector (Movable Portion), Plug	W	Cable, Transmission Path, Wire
E	Miscellaneous Electrical Part	Q	Silicon Controlled Rectifier (SCR), Transistor, Triode Thyristor	X	Socket
F	Fuse	R	Resistor	Y	Crystal Unit (Piezoelectric, Quartz)
		RT	Thermistor	Z	Tuned Cavity, Tuned Circuit

ABBREVIATIONS

A		CBL	Cable	E	
A	Across Flats, Acrylic, Air (Dry Method), Ampere	CER	Ceramic	E	Enamel (Insulation, Enhancement, Extension)
ADJ	Adjust, Adjustment	CH	Center Hole	E-MODE	Enhancement Mode
AL	Aluminum	CHAM	Chamfer	EPROM	Eraseable Programmable Read Only Memory
ALC	Alcohol, Automatic Level Control	CHAN	Channel	EXCL	Excluding, Exclusive
AMP	Amperage	COAX	Coaxial	EXT	Extended, Extension, External, Extinguish
AMPL	Amplifier	COM	Commercial, Common		
ANDZ	Anodized	CONN	Connect, Connection, Connector		
ANLG	Analog	CONT	Contact, Continuous, Control, Controller		
ASSY	Assembly	CONV	Converter		
ASTBL	Astable	CP	Cadmium Plate, Candle Power, Centipoise, Conductive Plastic, Cone Point		
ATTEN	Attenuation, Attenuator	CRP	Crepe, Crimp		
AWG	American Wire Gauge	CTR	Center		
		CURRNT	Current		
B		D			
BCKT	Bracket	D	Deep, Depletion, Depth, Diameter, Direct Current	F	Fahrenheit, Farad, Female, Film, (Resistor), Fixed, Flange, Flint, Flourine, Frequency
BD	Board, Bundle	D/A	Digital-to-Analog	FDTHRU	Feed Through
BE	Baume, Beryllium	DAP	Diallyl Phthalate	FEM	Female
BFR	Before, Buffer	DB	Decibel, Double Break	FF	Flange, Female Connection; Flip Flop
BLK	Black, Blank, Block	DC	Direct Current, Double Contact	FL	Flash, Flat, Fluid
BNC	Type of Connector	DBL	Double	FLEX	Flexible
BSC	Basic	DCDR	Decoder	FLG	Flange
BVR	Reverse, Breakdown Voltage	DEG	Degree	FLTR	Filter, Floater
		DIA	Diameter	FT	Current Gain Bandwidth
C		DIFF	Differential	FM	Flange, Male Connection; Foam, Frequency Modulation Product (Transition Frequency); Feet, Foot
C	Capacitance, Capacitor, Center Tapped, Centistoke, Ceramic, Cermet, Circular Mil Foot, Closed Cup, Cold, Compression	DIP	Dual In-Line Package	FXD	Fixed
		DO	Package Type Designation		
		DRVR	Driver		
				G	
				GEN	General, Generator
				GHZ	Gigahertz
				GP	General Purpose Group
				GL	Glass
				GRN	Green
				GRV	Grooved

Table 6-2. Reference Designations, Abbreviations, and Manufacturer's Code List (2 of 3)

H		
H	Henry, Hermaphrodite, High, Hole Diameter, Hot, Hub Inside Diameter, Hydrogen	
HD	Hand, Hard, Head, Heavy Duty	
HEX	Hexadecimal, Hexagon, Hexagonal	
HGT	Height	
I		
IC	Collector Current, Integrated Circuit	
ID	Identification, Inside Diameter	
IF	Forward Current, Intermediate Frequency	
IMPD	Impedance	
IN	Inch, Indium	
INP	Input	
INS	Insert, Inside, Insulation, Insulator	
INT	Integral, Intensity, Internal	
INTL	Internal, International	
INV	Invert, Inverter	
J		
JFET	Effect Transistor	
K		
K	Kelvin, Key, Kilo, Potassium	
KB	Knob	
L		
LED	Light Emitting Diode	
LG	Length, Long	
LIN	Linear, Linear Taper, Linearity	
LK	Link, Lock	
LKG	Leakage, Locking	
LKWR	Lockwasher	
LS	Loudspeaker, Low Power Schottky, Series Inductance	
LUM	Luminous	
M		
M	Male, Maximum, Mega, Mil, Milli, Mode, Momentary, Mounting Hole Centers, Mounting Hole Diameter	
MA	Milliampere	
MACH	Machined	
MAX	Maximum	
MCD	Millacandela	
MICPROC	Microprocessor	
MIN	Miniature, Minimum, Minor, Minute	
MLD	Mold, Molded	
MM	Magnetized Material (Restricted Articles Code), Millimeter	
MO	Metal Oxide, Milliounce, Molybdenum	
MOD	Model, Modified Modular, Modulated, Modulator	
MOM	Momentary, Motherboard	
MTG	Mounting	
MTLC	Metallic	
MTR	Meter	
MULTIPLXR	Multiplexer	
MULTR	Multiplier	
MUW	Music Wire	
MW	Milliwatt	
N		
N-CHAN	N-Channel Metal Oxide Semiconductor	
NB	Niobium	
NCH	Notched	
NEG	Negative	
NH	Nanohenry	
NM	Nanometer, Nonmetallic	
NO	Normally Open, Number	
NPN	Negative Positive Negative (Transistor)	
NS	Nanosecond, Non-Shorting, Nose	
NYL	Nylon (Polyamide)	
O		
OCTL	Octal	
OD	Olive Drab, Outside Diameter	
OP	Operational	
OPT	Optical, Option, Optional	
OXD	Oxide	
P		
PAN-HD	Pan Head	
PC	Picocoulomb, Piece, Printed Circuit	
P.C.	Printed Circuit	
PCB	Printed Circuit Board	
PD	Pad, Palladium, Pitch Diameter, Power Dissipation	
PF	Picofarad; Pipe, Female Connection; Power Factor	
PKG	Package	
PL	Phase Lock, Plain, Plate, Plug	
PL-MTG	Plate Mounting	
PLSTC	Plastic	
PN	Part Number	
PNP	Positive Negative Positive (Transistor)	
POLYC	Polycarbonate	
POLYE	Polyester	
POLYI	Polyimide	
POS	Position, Positive	
POZI	Pozidrive Recess	
PRCN	Precision	
PRIM	Primary	
PRL	Parallel	
PRP	Purple, Purpose	
P/S	Power Supply	
PT	Part, Pint, Platinum, Point, Pulse Time	
PVC	Polyvinyl Chloride	
PW	Power Wirewound, Pulse Width	
Q		
QUAD	Set of Four	
R		
RBN	Ribbon	
RCVR	Receiver	
RECT	Rectangle, Rectangular, Rectifier	
RES	Research, Resistance, Resistor, Resolution	
RET	Retaining	
RF	Radio Frequency	
RFI	Radio Frequency Interference	
RFLTR	Regulator	
RKR	Rocker	
RND	Round	
RPG	Rotary Pulse Generator	
RR	Rear	
RVT	Rivet, Riveted	
S		
SCR	Screw, Scrub, Silicon Controlled Rectifier	
SEC	Secondary	
SER	Serial, Series	
SGL	Single	
SHFT	Shaft	
SHLDR	Shoulder	
SI	Silicon, Square Inch	
SIG	Signal, Significant	
SIP	Single In-Line Package	
SKT	Skirt, Socket	
SLDR	Solder	
SM	Samarium, Seam, Small, Square Meter, Sub Modular, Subminiature	
SMB	Subminiature, B Type (Snap-On Connector)	

Table 6-2. Reference Designations, Abbreviations, and Manufacturer's Code List (3 of 3)

SNP Snap	TO Package Type	W
SPCL Special	TPL Triple	W Watt, Wattage, White,
SQ Square	TRIG Trigger, Triggerable, Triggering, Trigonometry	WB Wide Band
SST Stainless Steel	TRMR Trimmer	WD Width, Wire
STDF Standoff	TRN Turn, Turns	
SZ Size	TTL Tan Translucent, Transistor, Transistor Logic	
T		X
T Tab Width, Taper, Teeth, Temperature, Tera, Tesla, Thermoplastic (Insulation), Thickness, Time, Timed, Tooth, Turns Ratio, Typical	U	XSTR Transistor
TA Ambient Temperature, Tantalum	UCD Microcandela	
TC Thermoplastic	UNCT Undercut	Y
TFE Polytetrafluoro - ethylene, Teflon	UF Microfarad	YIG Yttrium-iron-garnet
THD Thread, Threaded	V	YTM YIG Tuned Multiplier
THK Thick	V Vanadium, Variable, Violet, Volt, Voltage	
	VA Volt Ampere	Z
	VDC Volts, Direct Current	ZN-P Zinc Plate
	VID Video	ZNR Zener

MANUFACTURER'S CODE LIST

Mfr Code	Manufacturer Name	Address	Zip Code
00000	Any Satisfactory Supplier		
00779	AMP Inc	Harrisburg	PA 17111
01121	Allen-Bradley Co Inc	El Paso	TX 79935
01295	Texas Instruments Inc	Dallas	TX 75265
01417	Chrysler Corp Defense Opn Div	Detroit	MI 48203
02610	Samsonite Corp	Denver	CO 80217
02886	Dodge-Wasmund Mfg Inc	Pico Rivera	CA 90660
03888	K D I Pyrofilm Corp	Whippany	NJ 07981
04213	Caddell-Burns Mfg Co Inc	Mineola	NY 11501
04713	Motorola Inc Semi-Cond Prod	Phoenix	AX 85008
04835	Colt Ind Inc Crucible Inc Div	Pittsburgh	PA 15230
06665	Precision Monolithics Inc	Santa Clara	CA 95050
06915	Richco Plastic Co	Chicago	IL 60646
07263	Fairchild Corp	Mountain View	CA 94042
11236	CTS Corp Berne Div	Berne	IN 46711
13606	Sprague Electric Semicon Div	Concord	NH 03301
15454	Ametek Inc Rodan Div	Anaheim	CA 92806
17856	Siliconix Inc	Santa Clara	CA 95054
18324	Signetics Corp	Sunnyvale	CA 94086
19701	Mepco/Electra Inc	Mineral Wells	TX 76067
24546	Corning Electronics	Santa Clara	CA 95050
27014	National Semiconductor Corp	Santa Clara	CA 95052
27167	Corning Glass Works (Wilmington)	Wilmington	NC 28401
28480	Hewlett-Packard Co Corporate HQ	Palo Alto	CA 94304
3L585	RCA Corp Solid State Div	Somerville	NJ
32997	Bourns Inc	Riverside	CA 92507
34649	Intel Corp	Santa Clara	CA 95054
56289	Sprague Electric Co	North Adams	MA 01247
9D949	Allied Amphenol Products	Lisle	IL 60532
9N171	Unitrode Corp	Lexington	MA 02173
91637	Dale Electronics Inc	El Paso	TX 79936

Table 6-3. HP 83570A Replaceable Parts

Reference Designation	HP Part Number	C D	Qty	Description	Mfr Code	Mfr Part Number
A1	83570-60071	0	1	FRONT PANEL	28480	83570-60071
A1C1	0160-4084	8	1	CAPACITOR-FXD .1UF ± 20% 50VDC CER	28480	0160-4084
A1C2	0160-3879	7	3	CAPACITOR-FXD .01UF ± 20% 100VDC CER	28480	0160-3879
A1C3	0160-3879	7		CAPACITOR-FXD .01UF ± 20% 100VDC CER	28480	0160-3879
A1C4	0160-3879	7		CAPACITOR-FXD .01UF ± 20% 100VDC CER	28480	0160-3879
A1DS1	1990-0670	0	5	LED-LAMP LUM-INT=1MCD IF=20MA-MAX BVR=5V	28480	1990-0670
A1DS2	1990-0670	0		LED-LAMP LUM-INT=1MCD IF=20MA-MAX BVR=5V	28480	1990-0670
A1DS3	1990-0670	0		LED-LAMP LUM-INT=1MCD IF=20MA-MAX BVR=5V	28480	1990-0670
A1DS4	1990-0487	7	2	LED-LAMP LUM-INT=2MCD BVR=5V	28480	HLMP-1401
A1DS5	1990-0487	7		LED-LAMP LUM-INT=2MCD BVR=5V	28480	HLMP-1401
A1DS6	1990-0670	0		LED-LAMP LUM-INT=1MCD IF=20MA-MAX BVR=5V	28480	1990-0670
A1DS7	1990-0670	0		LED-LAMP LUM-INT=1MCD IF=20MA-MAX BVR=5V	28480	1990-0670
A1DS8	1990-0486	6	1	LED-LAMP LUM-INT=2MCD IF=25MA-MAX BVR=5V	28480	HLMP-1301
A1DS9	1990-0699	3	3	LED-LIGHT BAR MODULE LUM-INT=7MCD	28480	1LM1-2350
A1DS10	1990-0699	3		LED-LIGHT BAR MODULE LUM-INT=7MCD	28480	1LM1-2350
A1DS11	1990-0699	3		LED-LIGHT BAR MODULE LUM-INT=7MCD	28480	1LM1-2350
A1J1	1251-4736	1	1	CONN-POST TYPE .100-PIN-SPCG 26-CONT	28480	1251-4736
A1MP1	0380-1233	9	3	SPACER-SPECIALTY .450 IN LG; .175 IN OD	00000	ORDER BY DESCRIPTION
A1MP2	2190-0067	4	1	WASHER-LK INTL T 1/4 IN .256-IN-ID	28480	2190-0067
A1MP3	2950-0006	3	1	NUT-HEX-DBL-CHAM 1/4-32-THD .094-IN-THK	00000	ORDER BY DESCRIPTION
A1MP4	0890-0052	9	1	TUBING-HS 1-IN-D/5-IN-RCVD .035-IN-WALL	28480	0890-0052
A1MP5				NOT ASSIGNED		
A1MP6	2190-0016	3	2	WASHER-LK INTL T 3/8 IN .377-IN-ID	28480	2190-0016
A1MP7	2950-0001	8	1	NUT-HEX-DBL-CHAM 3/8-32-THD .094-IN-THK	00000	ORDER BY DESCRIPTION
A1Q1	1854-0019	3	1	TRANSISTOR NPN SI TO-18 PD=360MW	28480	1854-0019
A1R1	2100-4022	0	1	RESISTOR-VAR CONTROL CP 10K 10% LIN	28480	2100-4022
A1R2				NOT ASSIGNED		
A1R3	0698-3440	7	1	RESISTOR 196 1% .125W F TC=0 ± 100	24546	CT4-1/8-TO-196R-F
A1R4	0757-0398	4	3	RESISTOR 75 1% .125W F TC=0 ± 100	24546	CT4-1/8-TO-75R0-F
A1R5	0757-0398	4		RESISTOR 75 1% .125W F TC=0 ± 100	24546	CT4-1/8-TO-75R0-F
A1R6	0757-0398	4		RESISTOR 75 1% .125W F TC=0 ± 100	24546	CT4-1/8-TO-75R0-F
A1R7	0698-7236	7	1	RESISTOR 1K 1% .05W F TC=0 ± 100	24546	C3-1/8-TO-1001-F
A1R8	0698-7224	3	7	RESISTOR 316 1% .05W F TC=0 ± 100	24546	C3-1/8-TO-316R-F
A1R9	0698-7224	3		RESISTOR 316 1% .05W F TC=0 ± 100	24546	C3-1/8-TO-316R-F
A1R10	0698-7224	3		RESISTOR 316 1% .05W F TC=0 ± 100	24546	C3-1/8-TO-316R-F
A1R11	0698-7224	3		RESISTOR 316 1% .05W F TC=0 ± 100	24546	C3-1/8-TO-316R-F
A1R12	0698-7224	3		RESISTOR 316 1% .05W F TC=0 ± 100	24546	C3-1/8-TO-316R-F
A1R13	0698-7224	3		RESISTOR 316 1% .05W F TC=0 ± 100	24546	C3-1/8-TO-316R-F
A1R14	0698-7224	3		RESISTOR 316 1% .05W F TC=0 ± 100	24546	C3-1/8-TO-316R-F
A1RPG1	0960-0683	1	1	ROTARY PULSE GENERATOR INPUT POWER: 5VDC	28480	0960-0683
A1S1	5060-9436	7	8	PUSHBUTTON SWITCH P.C. MOUNT	28480	5060-9436
A1S2	5060-9436	7		PUSHBUTTON SWITCH P.C. MOUNT	28480	5060-9436
A1S3	5060-9436	7		PUSHBUTTON SWITCH P.C. MOUNT	28480	5060-9436
A1S4	5060-9436	7		PUSHBUTTON SWITCH P.C. MOUNT	28480	5060-9436
A1S5	5060-9436	7		PUSHBUTTON SWITCH P.C. MOUNT	28480	5060-9436
A1S6	5060-9436	7		PUSHBUTTON SWITCH P.C. MOUNT	28480	5060-9436
A1S7	5060-9436	7		PUSHBUTTON SWITCH P.C. MOUNT	28480	5060-9436
A1S8	5060-9436	7		PUSHBUTTON SWITCH P.C. MOUNT	28480	5060-9436
A1U1	1858-0047	5	2	TRANSISTOR ARRAY 16-PIN PLSTC DIP	13606	ULN-2003A
A1U2	1810-0124	9	1	NETWORK-RES 16-DIP 200.0 OHM X 8	28480	1810-0124
A1U3	1990-0738	1	1	DISPLAY-NUM-SEG 5-CHAR .152-H RED	28480	1990-0738
A1U4	1858-0047	5		TRANSISTOR ARRAY 16-PIN PLSTC DIP	13606	ULN-2003A
A1U5	1820-1416	5	1	IC SCHMITT-TRIG TTL LS INV HEX 1-INP	01295	SN74LS14N

Table 6-3. HP 83570A Replaceable Parts

Reference Designation	HP Part Number	C D	Qty	Description	Mfr Code	Mfr Part Number
A1U6	1820-2150	6	1	IC MICPROC-ACCESS NMOS	34649	D8279-5
A1U7				NOT ASSIGNED		
A1U8	1820-1196	8	1	IC FF TTL LS D-TYPE POS-EDGE-TRIG COM	01295	SN74LS174N
A1U9	1820-1730	6	1	IC FF TTL LS D-TYPE POS-EDGE-TRIG COM	01295	SN74LS273N
A1XU1 TO A1XU2				NOT ASSIGNED		
A1XU3	1251-5928	5	1	CONNECTOR 15-PIN M POST TYPE	28480	1251-5928
A1XU4 TO A1XU8				NOT ASSIGNED		
A1XU9	1200-0901	7	3	SOCKET-STRP 8-CONT SIP DIP-SLDR	28480	1200-0901
A1XU10	1200-0901	7		SOCKET-STRP 8-CONT SIP DIP-SLDR	28480	1200-0901
A1XU11	1200-0901	7		SOCKET-STRP 8-CONT SIP DIP-SLDR	28480	1200-0901

Table 6-3. HP 83570A Replaceable Parts

Reference Designation	HP Part Number	C D	Qty	Description	Mfr Code	Mfr Part Number
A2	5086-6300	4	1	DOUBLER ASSEMBLY INCLUDES A2A1 PULSE BOARD ASSEMBLY AND A2A2 DOUBLER MICROCIRCUIT ASSEMBLY (MUST BE REPLACED TOGETHER) *THESE FACTORY SELECTED RESISTORS ARE NOT INCLUDED WITH THE A2A1 PULSE ASSEMBLY. THEY ARE MOUNTED ON A HEADER INCLUDED WITH THE A2A2 DOUBLER MICROCIRCUIT ASSEMBLY.	28480	5086-6300
A2	5086-6300	2		EXCHANGE 5086-7300 DOUBLER ASSEMBLY	28480	5086-6300
A2MP1	83570-20027	2	1	HEAT SINK	28480	83570-20027
A2A1	83570-60064	1	1	PULSE NOT ASSIGNED	28480	83570-60064
A2A1C1				NOT ASSIGNED		
A2A1C2				NOT ASSIGNED		
A2A1C3	0160-0575	4	3	CAPACITOR-FXD .047UF ±20% 50VDC CER	28480	0160-0575
A2A1C4	0160-0575	4		CAPACITOR-FXD .047UF ±20% 50VDC CER	28480	0160-0575
A2A1C5	0160-2055	9	7	CAPACITOR-FXD .01UF +80-20% 100VDC CER	28480	0160-2055
A2A1C6	0160-2055	9		CAPACITOR-FXD .01UF +80-20% 100VDC CER	28480	0160-2055
A2A1C7	0160-2055	9		CAPACITOR-FXD .01UF +80-20% 100VDC CER	28480	0160-2055
A2A1C8	0160-2055	9		CAPACITOR-FXD .01UF +80-20% 100VDC CER	28480	0160-2055
A2A1C9	0160-2055	9		CAPACITOR-FXD .01UF +80-20% 100VDC CER	28480	0160-2055
A2A1C10	0160-0575	4		CAPACITOR-FXD .047UF ±20% 50VDC CER	28480	0160-0575
A2A1C11	0140-0205	5	1	CAPACITOR-FXD 62PF ±5% 300VDC MICA	72136	DM15E620J0300WV1CR
A2A1C12	0180-0116	1	2	CAPACITOR-FXD 6.8UF ±10% 35VDC TA	56289	150D685X9035B2
A2A1C13	0180-0116	1		CAPACITOR-FXD 6.8UF ±10% 35VDC TA	56289	150D685X9035B2
A2A1C14	0160-2055	9		CAPACITOR-FXD .01UF +80-20% 100VDC CER	28480	0160-2055
A2A1C15	0160-2055	9		CAPACITOR-FXD .01UF +80-20% 100VDC CER	28480	0160-2055
A2A1C16	0160-0572	1	3	CAPACITOR-FXD 2200PF ±20% 100VDC CER	28480	0160-0572
A2A1C17	0160-0572	1		CAPACITOR-FXD 2200PF ±20% 100VDC CER	28480	0160-0572
A2A1C18	0160-0572	1		CAPACITOR-FXD 2200PF ±20% 100VDC CER	28480	0160-0572
A2A1CR1	1901-0040	1	2	DIODE-SWITCHING 30V 50MA 2NS DO-35	9N171	1N4148
A2A1CR2	1901-0040	1		DIODE-SWITCHING 30V 50MA 2NS DO-35	9N171	1N4148
A2A1CR3	1901-0033	2	13	DIODE-GEN PRP 180V 200MA DO-35	9N171	1N645
A2A1CR4	1901-0033	2		DIODE-GEN PRP 180V 200MA DO-35	9N171	1N645
A2A1CR5	1901-0033	2		DIODE-GEN PRP 180V 200MA DO-35	9N171	1N645
A2A1CR6	1901-0033	2		DIODE-GEN PRP 180V 200MA DO-35	9N171	1N645
A2A1CR7	1901-0033	2		DIODE-GEN PRP 180V 200MA DO-35	9N171	1N645
A2A1CR8	1901-0033	2		DIODE-GEN PRP 180V 200MA DO-35	9N171	1N645
A2A1CR9	1901-0033	2		DIODE-GEN PRP 180V 200MA DO-35	9N171	1N645
A2A1CR10	1901-0033	2		DIODE-GEN PRP 180V 200MA DO-35	9N171	1N645
A2A1CR11	1901-0033	2		DIODE-GEN PRP 180V 200MA DO-35	9N171	1N645
A2A1CR12	1901-0033	2		DIODE-GEN PRP 180V 200MA DO-35	9N171	1N645
A2A1CR13	1901-0033	2		DIODE-GEN PRP 180V 200MA DO-35	9N171	1N645
A2A1CR14	1901-0033	2		DIODE-GEN PRP 180V 200MA DO-35	9N171	1N645
A2A1CR15	1901-0179	7	1	DIODE-SWITCHING 15V 50MA 750PS DO-7	07263	FD777
A2A1CR16	1901-0050	3	1	DIODE-SWITCHING 80V 200MA 2NS DO-35	9N171	1N4150
A2A1CR17	1901-0518	8	2	DIODE-SM SIG SCHOTTKY	28480	1901-0518
A2A1CR18	1901-0518	8		DIODE-SM SIG SCHOTTKY	28480	1901-0518
A2A1CR19	1901-0033	2		DIODE-GEN PRP 180V 200MA DO-35	9N171	1N645
A2A1J1	1250-0257	1	1	CONNECTOR-RF SMB M PC 50-OHM	28480	1250-0257
A2A1J2	1251-5618	0	1	CONNECTOR 8-PIN M POST TYPE	28480	1251-5618
A2A1J3	1251-6343	0	1	CONNECTOR 18-PIN M POST TYPE	28480	1251-6343

Table 6-3. HP 83570A Replaceable Parts

Reference Designation	HP Part Number	C D	Qty	Description	Mfr Code	Mfr Part Number
A2A1L1	9100-1788	6	1	CORE-FERRITE CHOKE-WIDEBAND;IMP:>680	28480	9100-1788
A2A1MP1	1251-3172	7	12	CONNECTOR-SGL CONT SKT .03-IN-BSC-SZ RND	28480	1251-3172
A2A1MP2	0380-1104	3	4	SPACER-RVT-ON .094-IN-LG .152-IN-ID	28480	0380-1104
A2A1MP3	1205-0095	0	3	HEAT SINK SGL TO-5/TO-39-CS	30161	3225B
A2A1MP4	1200-0173	5	3	INSULATOR-XSTR DAP-GL	28480	1200-0173
A2A1Q1	1854-0637	1	3	TRANSISTOR NPN 2N2219A SI TO-5 PD=800MW	01295	2N2219A
A2A1Q2	1853-0281	9	1	TRANSISTOR PNP 2N2907A SI TO-18 PD=400MW	04713	2N2907A
A2A1Q3	1854-0404	0	1	TRANSISTOR NPN SI TO-18 PD=360MW	28480	1854-0404
A2A1Q4	1854-0637	1		TRANSISTOR NPN 2N2219A SI TO-5 PD=800MW	01295	2N2219A
A2A1Q5	1854-0023	9	1	TRANSISTOR NPN SI TO-18 PD=360MW	28480	1854-0023
A2A1Q6	1854-0477	7	2	TRANSISTOR NPN 2N2222A SI TO-18 PD=500MW	04713	2N2222A
A2A1Q7	1853-0405	9	1	TRANSISTOR PNP SI PD=300MW FT=850MHZ	04713	2N4209
A2A1Q8	1854-0019	3	1	TRANSISTOR NPN SI TO-18 PD=360MW	28480	1854-0019
A2A1Q9	1854-0637	1		TRANSISTOR NPN 2N2219A SI TO-5 PD=800MW	01295	2N2219A
A2A1Q10	1854-0477	7		TRANSISTOR NPN 2N2222A SI TO-18 PD=500MW	04713	2N2222A
A2A1R1 TO A2A1R14				FACTORY SELECTED-NOT FIELD REPLACEABLE		
A2A1R15	0757-0401	0	4	RESISTOR 100 1% .125W F TC=0±100	24546	CT4-1/8-TO-101-F
A2A1R16	0698-7253	8	9	RESISTOR 5.11K 1% .05W F TC=0±100	24546	C3-1/8-TO-5111-F
A2A1R17	0698-7260	7	11	RESISTOR 10K 1% .05W F TC=0±100	24546	C3-1/8-TO-1002-F
A2A1R18	0698-7260	7		RESISTOR 10K 1% .05W F TC=0±100	24546	C3-1/8-TO-1002-F
A2A1R19	0698-7253	8		RESISTOR 5.11K 1% .05W F TC=0±100	24546	C3-1/8-TO-5111-F
A2A1R20	0698-7260	7		RESISTOR 10K 1% .05W F TC=0±100	24546	C3-1/8-TO-1002-F
A2A1R21	2100-3749	6	2	RESISTOR-TRMR 5K 10% C SIDE-ADJ 17-TRN	28480	2100-3749
A2A1R22	0698-7257	2	2	RESISTOR 7.5K 1% .05W F TC=0±100	24546	C3-1/8-TO-7501-F
A2A1R23	0698-7270	9	2	RESISTOR 26.1K 1% .05W F TC=0±100	24546	C3-1/8-TO-2612-F
A2A1R24	0698-7284	5	5	RESISTOR 100K 1% .05W F TC=0±100	24546	C3-1/8-TO-1003-F
A2A1R25	0698-7270	9		RESISTOR 26.1K 1% .05W F TC=0±100	24546	C3-1/8-TO-2612-F
A2A1R26	0698-7253	8		RESISTOR 5.11K 1% .05W F TC=0±100	24546	C3-1/8-TO-5111-F
A2A1R27	0698-7260	7		RESISTOR 10K 1% .05W F TC=0±100	24546	C3-1/8-TO-1002-F
A2A1R28	0698-7229	8	4	RESISTOR 511 1% .05W F TC=0±100	24546	C3-1/8-TO-511R-F
A2A1R29	0698-7258	3	3	RESISTOR 8.25K 1% .05W F TC=0±100	24546	C3-1/8-TO-8251-F
A2A1R30	0698-7261	8	1	RESISTOR 11K 1% .05W F TC=0±100	24546	C3-1/8-TO-1102-F
A2A1R31	0698-7236	7	3	RESISTOR 1K 1% .05W F TC=0±100	24546	C3-1/8-TO-1001-F
A2A1R32	0698-7260	7		RESISTOR 10K 1% .05W F TC=0±100	24546	C3-1/8-TO-1002-F
A2A1R33	0698-7253	8		RESISTOR 5.11K 1% .05W F TC=0±100	24546	C3-1/8-TO-5111-F
A2A1R34	0698-7284	5		RESISTOR 100K 1% .05W F TC=0±100	24546	C3-1/8-TO-1003-F
A2A1R35	0698-7257	2		RESISTOR 7.5K 1% .05W F TC=0±100	24546	C3-1/8-TO-7501-F
A2A1R36	0698-7258	3		RESISTOR 8.25K 1% .05W F TC=0±100	24546	C3-1/8-TO-8251-F
A2A1R37	0698-7284	5		RESISTOR 100K 1% .05W F TC=0±100	24546	C3-1/8-TO-1003-F
A2A1R38	0698-7229	8		RESISTOR 511 1% .05W F TC=0±100	24546	C3-1/8-TO-511R-F
A2A1R39	0698-3601	2	1	RESISTOR 10 5% 2W MO TC=0±200	27167	FP42-2-T00-10R0-J
A2A1R40	0698-7253	8		RESISTOR 5.11K 1% .05W F TC=0±100	24546	C3-1/8-TO-5111-F
A2A1R41	0698-7253	8		RESISTOR 5.11K 1% .05W F TC=0±100	24546	C3-1/8-TO-5111-F
A2A1R42	0698-7253	8		RESISTOR 5.11K 1% .05W F TC=0±100	24546	C3-1/8-TO-5111-F
A2A1R43	2100-3749	6		RESISTOR-TRMR 5K 10% C SIDE-ADJ 17-TRN	28480	2100-3749
A2A1R44	0698-7258	3		RESISTOR 8.25K 1% .05W F TC=0±100	24546	C3-1/8-TO-8251-F
A2A1R45	0698-7284	5		RESISTOR 100K 1% .05W F TC=0±100	24546	C3-1/8-TO-1003-F
A2A1R46	0698-7229	8		RESISTOR 511 1% .05W F TC=0±100	24546	C3-1/8-TO-511R-F
A2A1R47	0757-0401	0		RESISTOR 100 1% .125W F TC=0±100	24546	CT4-1/8-TO-101-F
A2A1R48	0757-0401	0		RESISTOR 100 1% .125W F TC=0±100	24546	CT4-1/8-TO-101-F
A2A1R49	0757-0401	0		RESISTOR 100 1% .125W F TC=0±100	24546	CT4-1/8-TO-101-F
A2A1R50	0698-3605	6	1	RESISTOR 15 5% 2W MO TC=0±200	27167	FP42-2-T00-15R0-J
A2A1R51	0698-7260	7		RESISTOR 10K 1% .05W F TC=0±100	24546	C3-1/8-TO-1002-F
A2A1R52	0698-7253	8		RESISTOR 5.11K 1% .05W F TC=0±100	24546	C3-1/8-TO-5111-F

Table 6-3. HP 83570A Replaceable Parts

Reference Designation	HP Part Number	C D	Qty	Description	Mfr Code	Mfr Part Number
A2A1R53	0698-3609	0	1	RESISTOR 22 5% 2W MO TC=0±200	27167	FP42-2-T00-22R0-J
A2A1R54	0698-7284	5		RESISTOR 100K 1% .05W F TC=0±100	24546	C3-1/8-T0-1003-F
A2A1R55	2100-0544	3	2	RESISTOR-TRMR 100K 10% C SIDE-ADJ 17-TRN	28480	2100-0544
A2A1R56	2100-0544	3		RESISTOR-TRMR 100K 10% C SIDE-ADJ 17-TRN	28480	2100-0544
A2A1R57	0698-7229	8		RESISTOR 511 1% .05W F TC=0±100	24546	C3-1/8-T0-511R-F
A2A1R58	0698-7244	7	1	RESISTOR 2.15K 1% .05W F TC=0±100	24546	C3-1/8-T0-2151-F
A2A1R59	0698-7236	7		RESISTOR 1K 1% .05W F TC=0±100	24546	C3-1/8-T0-1001-F
A2A1R60	0698-7253	8		RESISTOR 5.11K 1% .05W F TC=0±100	24546	C3-1/8-T0-5111-F
A2A1R61	0698-7260	7		RESISTOR 10K 1% .05W F TC=0±100	24546	C3-1/8-T0-1002-F
A2A1R62	0698-7260	7		RESISTOR 10K 1% .05W F TC=0±100	24546	C3-1/8-T0-1002-F
A2A1R63	0698-7236	7		RESISTOR 1K 1% .05W F TC=0±100	24546	C3-1/8-T0-1001-F
A2A1R64	0698-7260	7		RESISTOR 10K 1% .05W F TC=0±100	24546	C3-1/8-T0-1002-F
A2A1R65	0698-7260	7		RESISTOR 10K 1% .05W F TC=0±100	24546	C3-1/8-T0-1002-F
A2A1R66	0698-7260	7		RESISTOR 10K 1% .05W F TC=0±100	24546	C3-1/8-T0-1002-F
A2A1TP1 TO A2A1TP8				NOT ASSIGNED		
A2A1TP9	0360-0535	0	2	TERMINAL-TEST POINT .330IN ABOVE	28480	0360-0535
A2A1TP10	0360-0535	0		TERMINAL-TEST POINT .330IN ABOVE	28480	0360-0535
A2A1U1	1826-0557	5	2	IC OP AMP GP QUAD 14-DIP-C PKG	27014	LM348J
A2A1U2	1810-0037	3	1	NETWORK-RES 16-DIP 1.0K OHM X 8	11236	761-3-R1K
A2A1U3	1826-0557	5		IC OP AMP GP QUAD 14-DIP-C PKG	27014	LM348J
A2A1VR1				NOT ASSIGNED		
A2A1VR2	1902-0048	1	1	DIODE-ZNR 6.81V 5% DO-35 PD=.4W	28480	1902-0048
A2A1VR3	1902-0041	4	2	DIODE-ZNR 5.11V 5% DO-35 PD=.4W	07263	1N751A
A2A1VR4	1902-0041	4		DIODE-ZNR 5.11V 5% DO-35 PD=.4W	07263	1N751A
A2A1VR5	1902-0049	2	1	DIODE-ZNR 6.19V 5% DO-35 PD=.4W	28480	1902-0049
A2A1VR6	1902-3036	3	1	DIODE-ZNR 3.16V 5% DO-7 PD=.4W TC=-.064%	28480	1902-3036
A2A1VR7	1902-3104	6	1	DIODE-ZNR 5.62V 5% DO-35 PD=.4W	28480	1902-3104
A2A1VR8	1902-3094	3	1	DIODE-ZNR 5.11V 2% DO-35 PD=.4W	28480	1902-3094
A2A1XA4	1200-0553	5	1	SOCKET-IC 28-CONT DIP-SLDR	28480	1200-0553
A2A2				DOUBLER MICROCIRCUIT ASSEMBLY (NOT SEPARATELY REPLACEABLE)		

Table 6-3. HP 83570A Replaceable Parts

Reference Designation	HP Part Number	C D	Qty	Description	Mfr Code	Mfr Part Number
A3	83525-60080	6	1	DIGITAL INTERFACE	28480	83525-60080
A3C1	0160-0127	2	4	CAPACITOR-FXD 1UF ± 20% 50VDC CER	28480	0160-0127
A3C2	0160-0127	2		CAPACITOR-FXD 1UF ± 20% 50VDC CER	28480	0160-0127
A3C3	0160-0127	2		CAPACITOR-FXD 1UF ± 20% 50VDC CER	28480	0160-0127
A3C4	0160-0127	2		CAPACITOR-FXD 1UF ± 20% 50VDC CER	28480	0160-0127
A3C5	0160-3537	4	1	CAPACITOR-FXD 680PF ± 5% 100VDC MICA	28480	0160-3537
A3C6	0180-0500	7	1	CAPACITOR-FXD 47UF ± 20% 20VDC TA	28480	0180-0500
A3J1	1251-5926	3	1	CONNECTOR 50-PIN M POST TYPE	28480	1251-5926
A3MP1	5040-6852	3	1	BD EXTR ORANGE	28480	5040-6852
A3MP2	5000-9043	6	1	PIN	28480	5000-9043
A3R1	0757-0428	1	1	RESISTOR 1.62K 1% .125W F TC=0± 100	24546	CT4-1/8-T0-1621-F
A3R2	0698-3153	9	2	RESISTOR 3.83K 1% .125W F TC=0± 100	24546	CT4-1/8-T0-3831-F
A3R3	0698-3153	9		RESISTOR 3.83K 1% .125W F TC=0± 100	24546	CT4-1/8-T0-3831-F
A3R4	0698-7212	9	1	RESISTOR 100 1% .05W F TC=0± 100	24546	C3-1/8-T0-100R-F
A3S1	3101-2243	6	1	SWITCH-RKR DIP-RKR-ASSY 8-1A .05A 30VDC	28480	3101-2243
A3U1 TO A3U2				NOT ASSIGNED		
A3U3	1826-0180	0	1	IC TIMER TTL MONO/ASTBL 18324 NE555N		
A3U4	1820-2081	2	1	IC NMOS	04713	MC68A21P
A3U5	1820-3093	8	1	IC-8000-SERIES PROGRAMMABLE TIMER	28480	1820-3093
A3U6	1820-1202	7	1	IC GATE TTL LS NAND TPL 3-INP	01295	SN74LS10N
A3U7	1820-1197	9	1	IC GATE TTL LS NAND QUAD 2-INP	01295	SN74LS00N
A3U8	1820-1416	5	4	IC SCHMITT-TRIG TTL LS INV HEX 1-INP	01295	SN74LS14N
A3U9	1820-1216	3	2	IC DCDR TTL LS 3-TO-8-LINE 3-INP	01295	SN74LS138N
A3U10	1820-1416	5		IC SCHMITT-TRIG TTL LS INV HEX 1-INP	01295	SN74LS14N
A3U11	1820-1416	5		IC SCHMITT-TRIG TTL LS INV HEX 1-INP	01295	SN74LS14N
A3U12	1810-0338	7	3	NETWORK-RES 16-DIP 100.0 OHM X 8	11236	761-3-R100
A3U13	1820-1216	3		IC DCDR TTL LS 3-TO-8-LINE 3-INP	01295	SN74LS138N
A3U14	1820-1491	6	1	IC BFR TTL LS NON-INV HEX 1-INP	01295	SN74LS367AN
A3U15	1820-1416	5		IC SCHMITT-TRIG TTL LS INV HEX 1-INP	01295	SN74LS14N
A3U16	1810-0338	7		NETWORK-RES 16-DIP 100.0 OHM X 8	11236	761-3-R100
A3U17	1820-2075	4	2	IC TRANSCEIVER TTL LS BUS OCTL	01295	SN74LS245N
A3U18	1820-2075	4		IC TRANSCEIVER TTL LS BUS OCTL	01295	SN74LS245N
A3U19	1810-0338	7		NETWORK-RES 16-DIP 100.0 OHM X 8	11236	761-3-R100
A3XU1	1200-0541	1	2	SOCKET-IC 24-CONT DIP DIP-SLDR	28480	1200-0541
A3XU2	1200-0541	1		SOCKET-IC 24-CONT DIP DIP-SLDR	28480	1200-0541

Table 6-3. HP 83570A Replaceable Parts

Reference Designation	HP Part Number	C D	Qty	Description	Mfr Code	Mfr Part Number
A4	83570-60098	6	1	ALC	28480	83570-60077
A4C1	0160-3879	7	3	CAPACITOR-FXD .01UF ± 20% 100VDC CER	28480	0160-3879
A4C2				NOT ASSIGNED		
A4C3	0180-2617	1	1	CAPACITOR-FXD 6.8UF ± 10% 35VDC TA	25088	D6R8GS1B35K
A4C4	0160-0945	2	1	CAPACITOR-FXD 910PF ± 5% 100VDC MICA	28480	0160-0945
A4C5				NOT ASSIGNED		
A4C6				NOT ASSIGNED		
A4C7	0160-3874	2	2	CAPACITOR-FXD 10PF ± .5PF 200VDC CER	28480	0160-3874
A4C8	0160-4084	8	6	CAPACITOR-FXD .1UF ± 20% 50VDC CER	28480	0160-4084
A4C9	0160-4084	8		CAPACITOR-FXD .1UF ± 20% 50VDC CER	28480	0160-4084
A4C10	0180-2697	7	4	CAPACITOR-FXD 10UF ± 10% 25VDC TA	28480	0180-2697
A4C11	0160-3879	7		CAPACITOR-FXD .01UF ± 20% 100VDC CER	28480	0160-3879
A4C12	0160-3879	7		CAPACITOR-FXD .01UF ± 20% 100VDC CER	28480	0160-3879
A4C13	0160-4084	8		CAPACITOR-FXD .1UF ± 20% 50VDC CER	28480	0160-4084
A4C14	0160-0127	2	1	CAPACITOR-FXD 1UF ± 20% 50VDC CER	28480	0160-0127
A4C15	0180-2697	7		CAPACITOR-FXD 10UF ± 10% 25VDC TA	28480	0180-2697
A4C16	0180-2697	7		CAPACITOR-FXD 10UF ± 10% 25VDC TA	28480	0180-2697
A4C17	0180-2697	7		CAPACITOR-FXD 10UF ± 10% 25VDC TA	28480	0180-2697
A4C18	0180-2661	5	1	CAPACITOR-FXD 1UF ± 10% 50VDC TA	25088	D1R0GS1A50K
A4C19	0160-4084	8		CAPACITOR-FXD .1UF ± 20% 50VDC CER	28480	0160-4084
A4C20	0160-4084	8		CAPACITOR-FXD .1UF ± 20% 50VDC CER	28480	0160-4084
A4C21	0160-0573	2	1	CAPACITOR-FXD 4700PF ± 20% 100VDC CER	28480	0160-0573
A4C22	0160-3874	2		CAPACITOR-FXD 10PF ± .5PF 200VDC CER	28480	0160-3874
A4C23	0121-0448	8	1	CAPACITOR-V TRMR-CER 2.5-5PF 63V PC-MTG	28480	0121-0448
A4C24				NOT ASSIGNED		
A4C25	0160-4084	8		CAPACITOR-FXD .1UF ± 20% 50VDC CER	28480	0160-4084
A4C26 TO A4C28				NOT ASSIGNED		
A4C29	0160-3873	1	2	CAPACITOR-FXD 4.7PF ± .5PF 200VDC CER	28480	0160-3873
A4C30	0160-3873	1		CAPACITOR-FXD 4.7PF ± .5PF 200VDC CER	28480	0160-3873
A4CR1	1901-1098	1	1	DIODE-SWITCHING 1N415050V 200MA 4NS	15818	1N4150
A4CR2				NOT ASSIGNED		
A4CR3	1901-0535	9	3	DIODE-SM SIG SCHOTTKY	28480	1901-0535
A4CR4				NOT ASSIGNED		
A4CR5				NOT ASSIGNED		
A4CR6	1901-0050	3	2	DIODE-SWITCHING 80V 200MA 2NS DO-35	9N171	1N4150
A4CR7	1901-0535	9		DIODE-SM SIG SCHOTTKY	28480	1901-0535
A4CR8				NOT ASSIGNED		
A4CR9	1901-0535	9		DIODE-SM SIG SCHOTTKY	28480	1901-0535
A4CR10 TO A4CR12				NOT ASSIGNED		
A4CR13	1901-0050	3		DIODE-SWITCHING 80V 200MA 2NS DO-35	9N171	1N4150
A4J1	1258-0124	7	1	SHUNT-PROGRAMMABLE 1 DBL PIN SET; .100	28480	1258-0124
A4L1	9140-0210	1	1	INDUCTOR RF-CH-MLD 100UH 5%	28480	9140-0210
A4MP1	5040-6848	7	1	BOARD EXTR YELLO	28480	5040-6848
A4MP2	5000-9043	6	1	PIN	28480	5000-9043
A4MP3	1251-4932	9	2	CONNECTOR-SGL CONT SKT .021-IN-BSC-SZ	91506	LSG-1A14-1
A4MP4	7121-1152	0	1	LBL IN 83570	28480	7121-1152
A4MP5	1251-5177	6	2	CONNECTOR-SGL CONT PIN .031-IN-BSC-SZ	28480	1251-5177
A4Q1				NOT ASSIGNED		
A4Q2				NOT ASSIGNED		
A4Q3	1854-0295	7	2	TRANSISTOR-DUAL NPN PD=400MW	28480	1854-0295
A4Q4				NOT ASSIGNED		
A4Q5	1855-0386	9	2	TRANSISTOR J-FET 2N4392 N-CHAN D-MODE	04713	2N4392

Table 6-3. HP 83570A Replaceable Parts

Reference Designation	HP Part Number	C D	Qty	Description	Mfr Code	Mfr Part Number
A4Q6	1855-0386	9		TRANSISTOR J-FET 2N4392 N-CHAN D-MODE	04713	2N4392
A4Q7	1855-0423	5	3	TRANSISTOR MOSFET N-CHAN E-MODE TO-237	17856	VN10KM
A4Q8	1855-0423	5		TRANSISTOR MOSFET N-CHAN E-MODE TO-237	17856	VN10KM
A4Q9	1854-0295	7		TRANSISTOR-DUAL NPN PD=400MW	28480	1854-0295
A4Q10	1853-0316	1	2	TRANSISTOR-DUAL PNP PD=500MW	28480	1853-0316
A4Q11	1853-0316	1		TRANSISTOR-DUAL PNP PD=500MW	28480	1853-0316
A4Q12 TO A4Q15				NOT ASSIGNED		
A4Q16	1855-0423	5		TRANSISTOR MOSFET N-CHAN E-MODE TO-237	17856	VN10KM
A4R1 TO A4R4				NOT ASSIGNED		
A4R5	0698-7273	2	1	RESISTOR 34.8K 1% .05W F TC=0±100	24546	C3-1/8-T0-3482-F
A4R6				NOT ASSIGNED		
A4R7				NOT ASSIGNED		
A4R8	2100-2515	2	1	RESISTOR-TRMR 200K 10% C SIDE-ADJ 1-TRN	73138	82PAR200K
A4R9				NOT ASSIGNED		
A4R10	2100-0670	6	1	RESISTOR-TRMR 10K 10% C SIDE-ADJ 17-TRN	28480	2100-0670
A4R11				NOT ASSIGNED		
A4R12	2100-3611	1	1	RESISTOR-TRMR 50K 10% C SIDE-ADJ 17-TRN	28480	2100-3611
A4R13				NOT ASSIGNED		
A4R14				NOT ASSIGNED		
A4R15	2100-2489	9	1	RESISTOR-TRMR 5K 10% C SIDE-ADJ 1-TRN	73138	82PAR5K
A4R16	0698-7253	8	2	RESISTOR 5.11K 1% .05W F TC=0±100	24546	C3-1/8-T0-5111-F
A4R17	0698-7253	8		RESISTOR 5.11K 1% .05W F TC=0±100	24546	C3-1/8-T0-5111-F
A4R18	0698-7257	2	3	RESISTOR 7.5K 1% .05W F TC=0±100	24546	C3-1/8-T0-7501-F
A4R19	0698-7257	2		RESISTOR 7.5K 1% .05W F TC=0±100	24546	C3-1/8-T0-7501-F
A4R20	0698-7258	3	1	RESISTOR 8.25K 1% .05W F TC=0±100	24546	C3-1/8-T0-8251-F
A4R21	0698-7261	8	1	RESISTOR 11K 1% .05W F TC=0±100	24546	C3-1/8-T0-1102-F
A4R22	0698-7264	1	5	RESISTOR 14.7K 1% .05W F TC=0±100	24546	C3-1/8-T0-1472-F
A4R23	0757-0464	5	1	RESISTOR 90.9K 1% .125W F TC=0±100	24546	CT4-1/8-T0-9092-F
A4R24				NOT ASSIGNED		
A4R25	0698-7257	2		RESISTOR 7.5K 1% .05W F TC=0±100	24546	C3-1/8-T0-7501-F
A4R26	0698-7260	7	9	RESISTOR 10K 1% .05W F TC=0±100	24546	C3-1/8-T0-1002-F
A4R27	0698-7227	6	1	RESISTOR 422 1% .05W F TC=0±100	24546	C3-1/8-T0-422R-F
A4R28	0698-7254	9	1	RESISTOR 5.62K 1% .05W F TC=0±100	24546	C3-1/8-T0-5621-F
A4R29				NOT ASSIGNED		
A4R30	0837-0119	7	1	THERMISTOR TUB WITH AXL LEADS 5K-OHM	28480	0837-0119
A4R31	0698-7279	8	1	RESISTOR 61.9K 1% .05W F TC=0±100	24546	C3-1/8-T0-6192-F
A4R32	0698-7264	1		RESISTOR 14.7K 1% .05W F TC=0±100	24546	C3-1/8-T0-1472-F
A4R33	0698-7248	1	2	RESISTOR 3.16K 1% .05W F TC=0±100	24546	C3-1/8-T0-3161-F
A4R34	0698-3457	6	1	RESISTOR 316K 1% .125W F TC=0±100	28480	0698-3457
A4R35	0698-7260	7		RESISTOR 10K 1% .05W F TC=0±100	24546	C3-1/8-T0-1002-F
A4R36	0698-7260	7		RESISTOR 10K 1% .05W F TC=0±100	24546	C3-1/8-T0-1002-F
A4R37				NOT ASSIGNED		
A4R38	0698-7243	6	4	RESISTOR 1.96K 1% .05W F TC=0±100	24546	C3-1/8-T0-1961-F
A4R39	0698-7282	3	1	RESISTOR 82.5K 1% .05W F TC=0±100	24546	C3-1/8-T0-8252-F
A4R40	0698-7264	1		RESISTOR 14.7K 1% .05W F TC=0±100	24546	C3-1/8-T0-1472-F
A4R41				NOT ASSIGNED		
A4R42	0698-7256	1	2	RESISTOR 6.81K 1% .05W F TC=0±100	24546	C3-1/8-T0-6811-F
A4R43 TO A4R50				NOT ASSIGNED		
A4R51	0698-7236	7	3	RESISTOR 1K 1% .05W F TC=0±100	24546	C3-1/8-T0-1001-F
A4R52	0698-7212	9	4	RESISTOR 100 1% .05W F TC=0±100	24546	C3-1/8-T0-100R-F
A4R53				NOT ASSIGNED		
A4R54				NOT ASSIGNED		
A4R55	0698-7236	7		RESISTOR 1K 1% .05W F TC=0±100	24546	C3-1/8-T0-1001-F
A4R56	0698-7260	7		RESISTOR 10K 1% .05W F TC=0±100	24546	C3-1/8-T0-1002-F
A4R57	0698-7243	6		RESISTOR 1.96K 1% .05W F TC=0±100	24546	C3-1/8-T0-1961-F
A4R58	0698-7256	1		RESISTOR 6.81K 1% .05W F TC=0±100	24546	C3-1/8-T0-6811-F
A4R59	0698-7229	8	1	RESISTOR 511 1% .05W F TC=0±100	24546	C3-1/8-T0-511R-F

Table 6-3. HP 83570A Replaceable Parts

Reference Designation	HP Part Number	C D	Qty	Description	Mfr Code	Mfr Part Number
A4R60	0698-7247	0	1	RESISTOR 2.87K 1% .05W F TC=0±100	24546	C3-1/8-T0-2871-F
A4R61	0698-7219	6	1	RESISTOR 196 1% .05W F TC=0±100	24546	C3-1/8-T0-196R-F
A4R62	0698-7212	9		RESISTOR 100 1% .05W F TC=0±100	24546	C3-1/8-T0-100R-F
A4R63	0698-7243	6		RESISTOR 1.96K 1% .05W F TC=0±100	24546	C3-1/8-T0-1961-F
A4R64 TO A4R67				NOT ASSIGNED		
A4R68	0698-7222	1	1	RESISTOR 261 1% .05W F TC=0±100	24546	C3-1/8-T0-261R-F
A4R69	0698-7277	6	1	RESISTOR 51.1K 1% .05W F TC=0±100	24546	C3-1/8-T0-5112-F
A4R70	0698-7249	2	1	RESISTOR 3.48K 1% .05W F TC=0±100	24546	C3-1/8-T0-3481-F
A4R71	0698-7268	5	1	RESISTOR 21.5K 1% .05W F TC=0±100	24546	C3-1/8-T0-2152-F
A4R72	0698-7212	9		RESISTOR 100 1% .05W F TC=0±100	24546	C3-1/8-T0-100R-F
A4R73	0698-7212	9		RESISTOR 100 1% .05W F TC=0±100	24546	C3-1/8-T0-100R-F
A4R74	0698-7243	6		RESISTOR 1.96K 1% .05W F TC=0±100	24546	C3-1/8-T0-1961-F
A4R75	0698-7274	3	1	RESISTOR 38.3K 1% .05W F TC=0±100	24546	C3-1/8-T0-3832-F
A4R76	0698-7260	7		RESISTOR 10K 1% .05W F TC=0±100	24546	C3-1/8-T0-1002-F
A4R77	0698-7260	7		RESISTOR 10K 1% .05W F TC=0±100	24546	C3-1/8-T0-1002-F
A4R78	2100-1986	9	1	RESISTOR-TRMR 1K 10% C TOP-ADJ 1-TRN	73138	82PR1K
A4R79	0698-7260	7		RESISTOR 10K 1% .05W F TC=0±100	24546	C3-1/8-T0-1002-F
A4R80	0698-7197	9	1	RESISTOR 23.7 1% .05W F TC=0±100	24546	C3-1/8-T0-23R7-F
A4R81	2100-2030	6	2	RESISTOR-TRMR 20K 10% C TOP-ADJ 1-TRN	73138	82PR20K
A4R82	2100-2030	6		RESISTOR-TRMR 20K 10% C TOP-ADJ 1-TRN	73138	82PR20K
A4R83	0698-7234	5	1	RESISTOR 825 1% .05W F TC=0±100	24546	C3-1/8-T0-825R-F
A4R84	0698-7232	3	1	RESISTOR 681 1% .05W F TC=0±100	24546	C3-1/8-T0-681R-F
A4R85	0698-7260	7		RESISTOR 10K 1% .05W F TC=0±100	24546	C3-1/8-T0-1002-F
A4R86				NOT ASSIGNED		
A4R87	0698-7236	7		RESISTOR 1K 1% .05W F TC=0±100	24546	C3-1/8-T0-1001-F
A4R88	0698-7264	1		RESISTOR 14.7K 1% .05W F TC=0±100	24546	C3-1/8-T0-1472-F
A4R89	0698-7263	0	1	RESISTOR 13.3K 1% .05W F TC=0±100	24546	C3-1/8-T0-1332-F
A4R90	0698-7264	1		RESISTOR 14.7K 1% .05W F TC=0±100	24546	C3-1/8-T0-1472-F
A4R91	0698-7240	3	1	RESISTOR 1.47K 1% .05W F TC=0±100	24546	C3-1/8-T0-1471-F
A4R92				NOT ASSIGNED		
A4R93	0698-7260	7		RESISTOR 10K 1% .05W F TC=0±100	24546	C3-1/8-T0-1002-F
A4R94	0698-7248	1		RESISTOR 3.16K 1% .05W F TC=0±100	24546	C3-1/8-T0-3161-F
A4R95				NOT ASSIGNED		
A4R96	0698-7251	6	1	RESISTOR 4.22K 1% .05W F TC=0±100	24546	C3-1/8-T0-4221-F
A4R97				NOT ASSIGNED		
A4R98				NOT ASSIGNED		
A4R99	2100-1738	9	1	RESISTOR-TRMR 10K 10% C TOP-ADJ 1-TRN	73138	82PR10K
A4R100 TO A4R107				NOT ASSIGNED		
A4R108	0698-7332	4	1	RESISTOR 1M 1% .125W F TC=0±100	28480	0698-7332
A4TP1	1251-5618	0	8	CONNECTOR 8-PIN M POST TYPE	28480	1251-5618
A4TP2	1251-5618	0		CONNECTOR 8-PIN M POST TYPE	28480	1251-5618
A4TP3	1251-5618	0		CONNECTOR 8-PIN M POST TYPE	28480	1251-5618
A4TP4	1251-5618	0		CONNECTOR 8-PIN M POST TYPE	28480	1251-5618
A4TP5	1251-5618	0		CONNECTOR 8-PIN M POST TYPE	28480	1251-5618
A4TP6	1251-5618	0		CONNECTOR 8-PIN M POST TYPE	28480	1251-5618
A4TP7	1251-5618	0		CONNECTOR 8-PIN M POST TYPE	28480	1251-5618
A4TP8	1251-5618	0		CONNECTOR 8-PIN M POST TYPE	28480	1251-5618
A4TP9	0360-0535	0	4	TERMINAL-TEST POINT .330IN ABOVE	28480	0360-0535
A4TP10	0360-0535	0		TERMINAL-TEST POINT .330IN ABOVE	28480	0360-0535
A4TP11	0360-0535	0		TERMINAL-TEST POINT .330IN ABOVE	28480	0360-0535
A4TP12	0360-0535	0		TERMINAL-TEST POINT .330IN ABOVE	28480	0360-0535
A4U1	1826-1186	8	2	ANALOG SWITCH 4 SPST 16 --CERDIP	06665	SW-06GQ
A4U2	1826-0616	7	2	IC OP AMP PRCN QUAD 14-DIP-C PKG	06665	OP-11EY
A4U3	1826-0610	1	2	IC MULTIPLXR 4-CHAN-ANLG DUAL 16-DIP-C	06665	MUX24FQ
A4U4	1826-1186	8		ANALOG SWITCH 4 SPST 16 --CERDIP	06665	SW-06GQ
A4U5	1826-0616	7		IC OP AMP PRCN QUAD 14-DIP-C PKG	06665	OP-11EY

Table 6-3. HP 83570A Replaceable Parts

Reference Designation	HP Part Number	C D	Qty	Description	Mfr Code	Mfr Part Number
A4U6	1826-0610	1		IC MULTIPLXR 4-CHAN-ANLG DUAL 16-DIP-C	06665	MUX24FQ
A4U7	1820-1197	9	1	IC GATE TTL LS NAND QUAD 2-INP	01295	SN74LS00N
A4U9	1826-0319	7	2	IC OP AMP LOW-BIAS-H-IMPD TO-99 PKG	04713	LF356G
A4U10	1826-0026	3	1	IC COMPARATOR PRCN TO-99 PKG	01295	LM311L
A4U11	1826-0752	2	1	D/A 12-BIT 16-CBRZ/SDR CMOS	24355	AD7542BD
A4U12	1820-1216	3	1	IC DCDR TTL LS 3-TO-8-LINE 3-INP	01295	SN74LS138N
A4U13	1820-1730	6	1	IC FF TTL LS D-TYPE POS-EDGE-TRIG COM	01295	SN74LS273N
A4U14	1820-1199	1	1	IC INV TTL LS HEX 1-INP	01295	SN74LS04N
A4U15	1820-1198	0	1	IC GATE TTL LS NAND QUAD 2-INP	01295	SN74LS03N
A4U16	1826-0021	8	1	IC OP AMP GP TO-99 PKG	27014	LM310H
A4U17	1826-0447	2	1	IC OP AMP WB TO-99 PKG	27014	LF257H
A4U18	1826-0319	7		IC OP AMP LOW-BIAS-H-IMPD TO-99 PKG	04713	LF356G
A4VR1	1902-0041	4	1	DIODE-ZNR 5.11V 5% DO-35 PD=.4W	07263	1N751A
A4VR2	1902-3139	7	1	DIODE-ZNR 8.25V 5% DO-35 PD=.4W	28480	1902-3139
A4VR3				NOT ASSIGNED		
A4VR4	1902-0049	2	2	DIODE-ZNR 6.19V 5% DO-35 PD=.4W	28480	1902-0049
A4VR5	1902-0049	2		DIODE-ZNR 6.19V 5% DO-35 PD=.4W	28480	1902-0049
A4W1	8159-0005	0	2	RESISTOR-ZERO OHMS 22 AWG LEAD DIA	28480	8159-0005
A4W2 TO A4W4				NOT ASSIGNED		
A4W5	8159-0005	0		RESISTOR-ZERO OHMS 22 AWG LEAD DIA	28480	8159-0005

Table 6-3. HP 83570A Replaceable Parts

Reference Designation	HP Part Number	C D	Qty	Description	Mfr Code	Mfr Part Number
A5	83570-60043	6	1	FM DRIVER	28480	83570-60043
A5C1	0160-0574	3	1	CAPACITOR-FXD .022UF ± 20% 100VDC CER	28480	0160-0574
A5C2	0160-0572	1	1	CAPACITOR-FXD 2200PF ± 20% 100VDC CER	28480	0160-0572
A5C3	0160-4084	8	5	CAPACITOR-FXD .1UF ± 20% 50VDC CER	28480	0160-4084
A5C4	0160-0945	2	1	CAPACITOR-FXD 910PF ± 5% 100VDC MICA	28480	0160-0945
A5C5	0160-0575	4	1	CAPACITOR-FXD .047UF ± 20% 50VDC CER	28480	0160-0575
A5C6	0160-2253	9	1	CAPACITOR-FXD 6.8PF ± .25PF 500VDC CER	28480	0160-2253
A5C7	0160-3879	7	10	CAPACITOR-FXD .01UF ± 20% 100VDC CER	28480	0160-3879
A5C8	0160-3879	7		CAPACITOR-FXD .01UF ± 20% 100VDC CER	28480	0160-3879
A5C9	0160-3879	7		CAPACITOR-FXD .01UF ± 20% 100VDC CER	28480	0160-3879
A5C10	0160-3879	7		CAPACITOR-FXD .01UF ± 20% 100VDC CER	28480	0160-3879
A5C11	0140-0198	5	1	CAPACITOR-FXD 200PF ± 5% 300VDC MICA	72136	DM15F201J0300WV1CR
A5C12	0160-2199	2	1	CAPACITOR-FXD 30PF ± 5% 300VDC MICA	28480	0160-2199
A5C13				NOT ASSIGNED		
A5C14	0121-0446	6	1	CAPACITOR-V TRMR .CER 4 5-20PF 160V	28480	0121-0446
A5C15	0160-3879	7		CAPACITOR-FXD .01UF ± 20% 100VDC CER	28480	0160-3879
A5C16	0160-3879	7		CAPACITOR-FXD .01UF ± 20% 100VDC CER	28480	0160-3879
A5C17	0160-3879	7		CAPACITOR-FXD .01UF ± 20% 100VDC CER	28480	0160-3879
A5C18	0160-3879	7		CAPACITOR-FXD .01UF ± 20% 100VDC CER	28480	0160-3879
A5C19				NOT ASSIGNED		
A5C20	0160-2249	3	2	CAPACITOR-FXD 4.7PF ± .25PF 500VDC CER	28480	0160-2249
A5C21				NOT ASSIGNED		
A5C22				NOT ASSIGNED		
A5C23	0160-4084	8		CAPACITOR-FXD .1UF ± 20% 50VDC CER	28480	0160-4084
A5C24	0160-4084	8		CAPACITOR-FXD .1UF ± 20% 50VDC CER	28480	0160-4084
A5C25	0160-3879	7		CAPACITOR-FXD .01UF ± 20% 100VDC CER	28480	0160-3879
A5C26	0160-3874	2	1	CAPACITOR-FXD 10PF ± .5PF 200VDC CER	28480	0160-3874
A5C27	0160-4084	8		CAPACITOR-FXD .1UF ± 20% 50VDC CER	28480	0160-4084
A5C28	0160-4084	8		CAPACITOR-FXD .1UF ± 20% 50VDC CER	28480	0160-4084
A5C29	0180-2617	1	4	CAPACITOR-FXD 6.8UF ± 10% 35VDC TA	25088	D6R8GS1B35K
A5C30	0180-2617	1		CAPACITOR-FXD 6.8UF ± 10% 35VDC TA	25088	D6R8GS1B35K
A5C31	0180-2617	1		CAPACITOR-FXD 6.8UF ± 10% 35VDC TA	25088	D6R8GS1B35K
A5C32	0180-2617	1		CAPACITOR-FXD 6.8UF ± 10% 35VDC TA	25088	D6R8GS1B35K
A5C33	0180-2207	5	1	CAPACITOR-FXD 100UF ± 10% 10VDC TA	56289	150D107X9010R2
A5C34	0180-0474	4	6	CAPACITOR-FXD 15UF ± 10% 20VDC TA	28480	0180-0474
A5C35	0180-0474	4		CAPACITOR-FXD 15UF ± 10% 20VDC TA	28480	0180-0474
A5C36	0180-0474	4		CAPACITOR-FXD 15UF ± 10% 20VDC TA	28480	0180-0474
A5C37	0180-0474	4		CAPACITOR-FXD 15UF ± 10% 20VDC TA	28480	0180-0474
A5C38	0180-0474	4		CAPACITOR-FXD 15UF ± 10% 20VDC TA	28480	0180-0474
A5C39	0180-0474	4		CAPACITOR-FXD 15UF ± 10% 20VDC TA	28480	0180-0474
A5C40	0160-3879	7		CAPACITOR-FXD .01UF ± 20% 100VDC CER	28480	0160-3879
A5C41	0160-2249	3		CAPACITOR-FXD 4.7PF ± .25PF 500VDC CER	28480	0160-2249
A5CR1	1901-0033	2	2	DIODE-GEN PRP 180V 200MA DO-35	9N171	1N645
A5CR2	1901-0033	2		DIODE-GEN PRP 180V 200MA DO-35	9N171	1N645
A5CR3	1901-0047	8	2	DIODE-SWITCHING 20V 75MA 10NS	28480	1901-0047
A5CR4	1901-0047	8		DIODE-SWITCHING 20V 75MA 10NS	28480	1901-0047
A5CR5	1901-1098	1	4	DIODE-SWITCHING 1N4150 50V 200MA 4NS	15818	1N4150
A5CR6	1901-1098	1		DIODE-SWITCHING 1N4150 50V 200MA 4NS	15818	1N4150
A5CR7	1901-1098	1		DIODE-SWITCHING 1N4150 50V 200MA 4NS	15818	1N4150
A5CR8	1901-1098	1		DIODE-SWITCHING 1N4150 50V 200MA 4NS	15818	1N4150
A5CR9	1901-0535	9	1	DIODE-SM SIG SCHOTTKY	28480	1901-0535
A5CR10	1901-0518	8	1	DIODE-SM SIG SCHOTTKY	28480	1901-0518
A5K1	0490-0916	6	1	RELAY-REED 1A 500MA 100VDC 5VDC-COIL	28480	0490-0916
A5K2	0490-1063	6	1	RELAY-REED 2A 500MA 50VDC 5VDC-COIL 10VA	28480	0490-1063

Table 6-3. HP 83570A Replaceable Parts

Reference Designation	HP Part Number	C D	Qty	Description	Mfr Code	Mfr Part Number
A5L1	9100-1630	7	1	INDUCTOR RF-CH-MLD 51UH 5%	28480	9100-1630
A5L2	9100-1619	2	4	INDUCTOR RF-CH-MLD 6.8UH 10%	28480	9100-1619
A5L3	9100-1619	2		INDUCTOR RF-CH-MLD 6.8UH 10%	28480	9100-1619
A5L4	08503-80001	9	1	COIL TOROID	28480	08503-80001
A5L5	9100-1619	2		INDUCTOR RF-CH-MLD 6.8UH 10%	28480	9100-1619
A5L6	9100-1619	2		INDUCTOR RF-CH-MLD 6.8UH 10%	28480	9100-1619
A5MP1	5000-9043	6	1	PIN	28480	5000-9043
A5MP2	4330-0145	9	1	INSULATOR-BEAD GLASS	28480	4330-0145
A5MP3	5040-6851	2	1	EXTRACTOR TAB	28480	5040-6851
A5MP4	7121-1152	0	1	LBL IN 83570	28480	7121-1152
A5MP5	1205-0011	0	1	HEAT SINK TO-5/TO-39-CS	28480	1205-0011
A5Q1	1854-0529	0	4	TRANSISTOR-DUAL NPN PD=750MW	28480	1854-0529
A5Q2	1854-0529	0		TRANSISTOR-DUAL NPN PD=750MW	28480	1854-0529
A5Q3	1854-0529	0		TRANSISTOR-DUAL NPN PD=750MW	28480	1854-0529
A5Q4	1854-0529	0		TRANSISTOR-DUAL NPN PD=750MW	28480	1854-0529
A5Q5	1854-0475	5	1	TRANSISTOR-DUAL NPN PD=750MW	28480	1854-0475
A5R1	0698-0083	8	4	RESISTOR 1.96K 1% .125W F TC=0±100	24546	CT4-1/8-TO-1961-F
A5R2	0757-0200	7	4	RESISTOR 5.62K 1% .125W F TC=0±100	24546	CT4-1/8-TO-5621-F
A5R3	0757-0200	7		RESISTOR 5.62K 1% .125W F TC=0±100	24546	CT4-1/8-TO-5621-F
A5R4	0757-0200	7		RESISTOR 5.62K 1% .125W F TC=0±100	24546	CT4-1/8-TO-5621-F
A5R5	0757-0200	7		RESISTOR 5.62K 1% .125W F TC=0±100	24546	CT4-1/8-TO-5621-F
A5R6	0757-0439	4	2	RESISTOR 6.81K 1% .125W F TC=0±100	24546	CT4-1/8-TO-6811-F
A5R7	0757-0439	4		RESISTOR 6.81K 1% .125W F TC=0±100	24546	CT4-1/8-TO-6811-F
A5R8	0698-3158	4	1	RESISTOR 23.7K 1% .125W F TC=0±100	24546	CT4-1/8-TO-2372-F
A5R9	0698-6360	6	2	RESISTOR 10K .1% .125W F TC=0±25	28480	0698-6360
A5R10	0698-3151	7	1	RESISTOR 2.87K 1% .125W F TC=0±100	24546	CT4-1/8-TO-2871-F
A5R11	0698-3155	1	2	RESISTOR 4.64K 1% .125W F TC=0±100	24546	CT4-1/8-TO-4641-F
A5R12	0698-0083	8		RESISTOR 1.96K 1% .125W F TC=0±100	24546	CT4-1/8-TO-1961-F
A5R13	0698-3446	3	1	RESISTOR 383 1% .125W F TC=0±100	24546	CT4-1/8-TO-383R-F
A5R14	0757-0394	0	2	RESISTOR 51.1 1% .125W F TC=0±100	24546	CT4-1/8-TO-51R1-F
A5R15	0757-0394	0		RESISTOR 51.1 1% .125W F TC=0±100	24546	CT4-1/8-TO-51R1-F
A5R16				NOT ASSIGNED		
A5R17	0757-0442	9	3	RESISTOR 10K 1% .125W F TC=0±100	24546	CT4-1/8-TO-1002-F
A5R18	0757-0442	9		RESISTOR 10K 1% .125W F TC=0±100	24546	CT4-1/8-TO-1002-F
A5R19	2100-3749	6	1	RESISTOR-TRMR 5K 10% C SIDE-ADJ 17-TRN	28480	2100-3749
A5R20	0757-0458	7	1	RESISTOR 51.1K 1% .125W F TC=0±100	24546	CT4-1/8-TO-5112-F
A5R21	0698-6360	6		RESISTOR 10K .1% .125W F TC=0±25	28480	0698-6360
A5R22	0698-3155	1		RESISTOR 4.64K 1% .125W F TC=0±100	24546	CT4-1/8-TO-4641-F
A5R23	0698-3152	8	1	RESISTOR 3.48K 1% .125W F TC=0±100	24546	CT4-1/8-TO-3481-F
A5R24				NOT ASSIGNED		
A5R25				NOT ASSIGNED		
A5R26	0698-0083	8		RESISTOR 1.96K 1% .125W F TC=0±100	24546	CT4-1/8-TO-1961-F
A5R27	0698-0083	8		RESISTOR 1.96K 1% .125W F TC=0±100	24546	CT4-1/8-TO-1961-F
A5R28	0757-0382	6	2	RESISTOR 16.2 1% .125W F TC=0±100	19701	5033R-1/8-TO-16R2-F
A5R29	0757-0382	6		RESISTOR 16.2 1% .125W F TC=0±100	19701	5033R-1/8-TO-16R2-F
A5R30	0757-0398	4	1	RESISTOR 75 1% .125W F TC=0±100	24546	CT4-1/8-TO-75R0-F
A5R31				NOT ASSIGNED		
A5R32	0757-0403	2	2	RESISTOR 121 1% .125W F TC=0±100	24546	CT4-1/8-TO-121R-F
A5R33	0698-7280	1	5	RESISTOR 68.1K 1% .05W F TC=0±100	24546	C3-1/8-TO-6812-F
A5R34	2100-2574	3	4	RESISTOR-TRMR 500 10% C SIDE-ADJ 1-TRN	73138	82PAR500
A5R35	0698-7280	1		RESISTOR 68.1K 1% .05W F TC=0±100	24546	C3-1/8-TO-6812-F
A5R36	2100-2574	3		RESISTOR-TRMR 500 10% C SIDE-ADJ 1-TRN	73138	82PAR500
A5R37	0698-7280	1		RESISTOR 68.1K 1% .05W F TC=0±100	24546	C3-1/8-TO-6812-F
A5R38	2100-2574	3		RESISTOR-TRMR 500 10% C SIDE-ADJ 1-TRN	73138	82PAR500
A5R39	0698-7280	1		RESISTOR 68.1K 1% .05W F TC=0±100	24546	C3-1/8-TO-6812-F
A5R40	2100-2574	3		RESISTOR-TRMR 500 10% C SIDE-ADJ 1-TRN	73138	82PAR500

Table 6-3. HP 83570A Replaceable Parts

Reference Designation	HP Part Number	C D	Qty	Description	Mfr Code	Mfr Part Number
A5R41	2100-3611	1	4	RESISTOR-TRMR 50K 10% C SIDE-ADJ 17-TRN	28480	2100-3611
A5R42	2100-3611	1		RESISTOR-TRMR 50K 10% C SIDE-ADJ 17-TRN	28480	2100-3611
A5R43	2100-3611	1		RESISTOR-TRMR 50K 10% C SIDE-ADJ 17-TRN	28480	2100-3611
A5R44	2100-3611	1		RESISTOR-TRMR 50K 10% C SIDE-ADJ 17-TRN	28480	2100-3611
A5R45	0757-0442	9		RESISTOR 10K 1% .125W F TC=0±100	24546	CT4-1/8-T0-1002-F
A5R46	0757-0420	3	2	RESISTOR 750 1% .125W F TC=0±100	24546	CT4-1/8-T0-751-F
A5R47	0757-0420	3		RESISTOR 750 1% .125W F TC=0±100	24546	CT4-1/8-T0-751-F
A5R48	2100-3759	8	1	RESISTOR-TRMR 2K 10% C SIDE-ADJ 17-TRN	28480	2100-3759
A5R49	0698-7280	1		RESISTOR 68.1K 1% .05W F TC=0±100	24546	C3-1/8-T0-6812-F
A5R50	2100-3750	9		RESISTOR-TRMR 20K 10% C SIDE-ADJ 17-TRN	28480	2100-3750
A5R51	0698-7278	7		RESISTOR 56.2K 1% .05W F TC=0±100	24546	C3-1/8-T0-5622-F
A5R52	0698-3160	8		RESISTOR 31.6K 1% .125W F TC=0±100	24546	CT4-1/8-T0-3162-F
A5R53	0757-0346	2	6	RESISTOR 10 1% .125W F TC=0±100	28480	0757-0346
A5R54	0757-0346	2		RESISTOR 10 1% .125W F TC=0±100	28480	0757-0346
A5R55	0757-0346	2		RESISTOR 10 1% .125W F TC=0±100	28480	0757-0346
A5R56	0757-0346	2	2	RESISTOR 10 1% .125W F TC=0±100	28480	0757-0346
A5R57	0757-0346	2		RESISTOR 10 1% .125W F TC=0±100	28480	0757-0346
A5R58	0757-0346	2		RESISTOR 10 1% .125W F TC=0±100	28480	0757-0346
A5R59 TO A5R66				NOT ASSIGNED		
A5R67	0698-3447	4	2	RESISTOR 422 1% .125W F TC=0±100	24546	CT4-1/8-T0-422R-F
A5R68	0698-3447	4		RESISTOR 422 1% .125W F TC=0±100	24546	CT4-1/8-T0-422R-F
A5R69 TO A5R72			4	NOT ASSIGNED		
A5R73	0757-0280	3		RESISTOR 1K 1% .125W F TC=0±100	24546	CT4-1/8-T0-1001-F
A5R74	0757-0280	3	1	RESISTOR 1K 1% .125W F TC=0±100	24546	CT4-1/8-T0-1001-F
A5R75	2100-2517	3		RESISTOR-TRMR 50K 10% C SIDE-ADJ 1-TRN	73138	82PAR50K
A5R76	0757-0280	4		RESISTOR 1K 1% .125W F TC=0±100	24546	CT4-1/8-T0-1001-F
A5R77	0757-0280	3		RESISTOR 1K 1% .125W F TC=0±100	24546	CT4-1/8-T0-1001-F
A5R78				NOT ASSIGNED		
A5R79	0757-0403	2	1	RESISTOR 121 1% .125W F TC=0±100	24546	CT4-1/8-T0-121R-F
A5R80	0698-0082	7		RESISTOR 464 1% .125W F TC=0±100	24546	CT4-1/8-T0-4640-F
A5TP1	0360-0535	0	11	TERMINAL-TEST POINT .330IN ABOVE	28480	0360-0535
A5TP2	0360-0535	0		TERMINAL-TEST POINT .330IN ABOVE	28480	0360-0535
A5TP3	0360-0535	0		TERMINAL-TEST POINT .330IN ABOVE	28480	0360-0535
A5TP4	0360-0535	0		TERMINAL-TEST POINT .330IN ABOVE	28480	0360-0535
A5TP5	0360-0535	0		TERMINAL-TEST POINT .330IN ABOVE	28480	0360-0535
A5TP6	0360-0535	0		TERMINAL-TEST POINT .330IN ABOVE	28480	0360-0535
A5TP7	0360-0535	0		TERMINAL-TEST POINT .330IN ABOVE	28480	0360-0535
A5TP8	0360-0535	0		TERMINAL-TEST POINT .330IN ABOVE	28480	0360-0535
A5TP9	0360-0535	0		TERMINAL-TEST POINT .330IN ABOVE	28480	0360-0535
A5TP10	0360-0535	0		TERMINAL-TEST POINT .330IN ABOVE	28480	0360-0535
A5TP11	0360-0535	0		28480	0360-0535	
A5U1	1810-0206	8	1	NETWORK-RES 8-SIP 10.0K OHM X 7	11236	750-81-R10K
A5U2	1810-0208	0		NETWORK-RES 8-SIP 68.0K OHM X 7	11236	750-81-R68K
A5U3	1826-0416	5		IC SWITCH ANLG QUAD 16-DIP-C PKG	27014	LF13331D
A5U4	1810-0205	7		NETWORK-RES 8-SIP 4.7K OHM X 7	11236	750-81-R4.7K
A5U5	1810-0321	8		NETWORK-RES 8-SIP 220.0K OHM X 7	11236	750-81-R220K

Table 6-3. HP 83570A Replaceable Parts

Reference Designation	HP Part Number	C D	Qty	Description	Mfr Code	Mfr Part Number
ASU6				NOT ASSIGNED		
ASU7	1826-0092	3	1	IC OP AMP GP DUAL TO-99 PKG	28480	1826-0092
ASU8	1826-0349	3	1	IC V RGLTR TO-39	07263	UA78M06HL
ASU9	1826-0558	6	1	IC 337 V RGLTR TO-39	27014	LM337H
ASU10	1826-0546	2	1	IC WIDEBAND AMPL VID TO-100 PKG	18324	NE592H
ASU11	1826-0476	7	1	IC SWITCH ANLG 8-DIP-P PKG	01295	TL601CP
ASU12				NOT ASSIGNED		
ASU13				NOT ASSIGNED		
ASU14	1826-0557	5	1	IC OP AMP GP QUAD 14-DIP-C PKG	27014	LM348J
ASU15				NOT ASSIGNED		
ASU16	1820-1196	8	1	IC FF TTL LS D-TYPE POS-EDGE-TRIG COM	01295	SN74LS174N
ASU17	1826-0699	6	1	D/A 8-BIT 16-CBRZ/SDR CMOS	24355	AD7524AD
ASU18	1820-1216	3	1	IC DCDR TTL LS 3-TO-8-LINE 3-INP	01295	SN74LS138N
ASU19	1826-0700	0	1	IC OP AMP WB 14-DIP-C PKG	34371	HA1-5195-5
ASU20	1820-0224	1	1	IC OP AMP SPCL TO-99 PKG	27014	LH0002CH
ASU21	1810-0366	1	1	NETWORK-RES 6-SIP 220.0 OHM X 5	11236	750-61-R220
A5VR1	1902-3002	3	2	DIODE-ZNR 2.37V 5% DO-7 PD=.4W TC=-.074%	28480	1902-3002
A5VR2	1902-3002	3		DIODE-ZNR 2.37V 5% DO-7 PD=.4W TC=-.074%	28480	1902-3002
A5W1	8159-0005	0	5	RESISTOR-ZERO OHMS 22 AWG LEAD DIA	28480	8159-0005
A5W2				NOT ASSIGNED		
A5W3				NOT ASSIGNED		
A5W4	8159-0005	0		RESISTOR-ZERO OHMS 22 AWG LEAD DIA	28480	8159-0005
A5W5	8159-0005	0		RESISTOR-ZERO OHMS 22 AWG LEAD DIA	28480	8159-0005
A5W6	8159-0005	0		RESISTOR-ZERO OHMS 22 AWG LEAD DIA	28480	8159-0005
A5W7				NOT ASSIGNED		
A5W8	8159-0005	0		RESISTOR-ZERO OHMS 22 AWG LEAD DIA	28480	8159-0005

Table 6-3. HP 83570A Replaceable Parts

Reference Designation	HP Part Number	C D	Qty	Description	Mfr Code	Mfr Part Number
A6	83545-60044	6	1	YO DRIVER	28480	83545-60044
A6C1	0160-3874	2	1	CAPACITOR-FXD 10PF ± .5PF 200VDC CER	28480	0160-3874
A6C2	0160-3878	6	3	CAPACITOR-FXD 1000PF ± 20% 100VDC CER	28480	0160-3878
A6C3	0160-3879	7	3	CAPACITOR-FXD .01UF ± 20% 100VDC CER	28480	0160-3879
A6C4	0160-4084	8	3	CAPACITOR-FXD .1UF ± 20% 50VDC CER	28480	0160-4084
A6C5	0160-3879	7		CAPACITOR-FXD .01UF ± 20% 100VDC CER	28480	0160-3879
A6C6	0160-4801	7	1	CAPACITOR-FXD 100PF ± 5% 100VDC CER	28480	0160-4801
A6C7	0180-3020	2	1	CAPACITOR-FXD 120UF ± 10% 50VDC TA	28480	0180-3020
A6C8	0180-2206	4	1	CAPACITOR-FXD 60UF ± 10% 6VDC TA	56289	150D606X9006B2
A6C9	0160-4084	8		CAPACITOR-FXD .1UF ± 20% 50VDC CER	28480	0160-4084
A6C10				NOT ASSIGNED		
A6C11	0160-3879	7		CAPACITOR-FXD .01UF ± 20% 100VDC CER	28480	0160-3879
A6C12				NOT ASSIGNED		
A6C13				NOT ASSIGNED		
A6C14	0180-2186	9	1	CAPACITOR-FXD 300UF ± 20% 30VDC TA	28480	0180-2186
A6C15	0160-3878	6		CAPACITOR-FXD 1000PF ± 20% 100VDC CER	28480	0160-3878
A6C16	0160-3878	6		CAPACITOR-FXD 1000PF ± 20% 100VDC CER	28480	0160-3878
A6C17	0180-0116	1	3	CAPACITOR-FXD 6.8UF ± 10% 35VDC TA	56289	150D685X9035B2
A6C18	0180-0116	1		CAPACITOR-FXD 6.8UF ± 10% 35VDC TA	56289	150D685X9035B2
A6C19	0180-2207	5	1	CAPACITOR-FXD 100UF ± 10% 10VDC TA	56289	150D107X9010R2
A6C20	0180-0116	1		CAPACITOR-FXD 6.8UF ± 10% 35VDC TA	56289	150D685X9035B2
A6C21	0180-0228	6	1	CAPACITOR-FXD 22UF ± 10% 15VDC TA	56289	150D226X9015B2
A6C22	0160-0574	3	1	CAPACITOR-FXD .022UF ± 20% 100VDC CER	28480	0160-0574
A6C23	0160-4084	8		CAPACITOR-FXD .1UF ± 20% 50VDC CER	28480	0160-4084
A6CR1	1901-0535	9	2	DIODE-SM SIG SCHOTTKY	28480	1901-0535
A6CR2	1901-0535	9		DIODE-SM SIG SCHOTTKY	28480	1901-0535
A6CR3	1901-0033	2	5	DIODE-GEN PRP 180V 200MA DO-35	9N171	1N645
A6CR4	1901-0033	2		DIODE-GEN PRP 180V 200MA DO-35	9N171	1N645
A6CR5	1901-0033	2		DIODE-GEN PRP 180V 200MA DO-35	9N171	1N645
A6CR6	1901-0033	2		DIODE-GEN PRP 180V 200MA DO-35	9N171	1N645
A6CR7	1901-0033	2		DIODE-GEN PRP 180V 200MA DO-35	9N171	1N645
A6K1	0490-0916	6	1	RELAY-REED 1A 500MA 100VDC 5VDC-COIL	28480	0490-0916
A6L1	9100-1666	9	2	INDUCTOR RF-CH-MLD 3.6MH 5%	28480	9100-1666
A6L2	9100-1666	9		INDUCTOR RF-CH-MLD 3.6MH 5%	28480	9100-1666
A6L3	08503-80001	9	1	COIL TOROID	28480	08503-80001
A6MP1	5040-6849	8	1	BD EXTR BLUE	28480	5040-6849
A6MP2	5000-9043	6	1	PIN	28480	5000-9043
A6MP3	1400-0774	6	1	CLIP-CMPNT .375-DIA .75-WD PVC	28480	1400-0774
A6Q1	1854-0477	7	1	TRANSISTOR NPN 2N2222A SI TO-18 PD=500MW	04713	2N2222A
A6Q2	1853-0044	2	2	TRANSISTOR PNP SI TO-39 PD=1W FT=200MHZ	28480	1853-0044
A6Q3	1853-0044	2		TRANSISTOR PNP SI TO-39 PD=1W FT=200MHZ	28480	1853-0044
A6R1				NOT ASSIGNED		
A6R2	0698-8484	9	4	RESISTOR 6.44K .1% .1W F TC=0+4	28480	0698-8484
A6R3				NOT ASSIGNED		
A6R4	0698-8484	9		RESISTOR 6.44K .1% .1W F TC=0+4	28480	0698-8484
A6R5	0698-8484	9		RESISTOR 6.44K .1% .1W F TC=0+4	28480	0698-8484
A6R6	0698-8484	9		RESISTOR 6.44K .1% .1W F TC=0+4	28480	0698-8484
A6R7	0698-6217	2	1	RESISTOR 200K .5% .125W F TC=0 ± 100	28480	0698-6217
A6R8	0698-6358	2	1	RESISTOR 100K .1% .125W F TC=0 ± 25	28480	0698-6358
A6R9	0698-3274	5	1	RESISTOR 10K 1% .125W F TC=0 ± 25	28480	0698-3274
A6R10	0698-3219	8	1	RESISTOR 300K .25% .125W F TC=0 ± 50	28480	0698-3219
A6R11	2100-3757	6	2	RESISTOR-TRMR 100 10% C SIDE-ADJ 17-TRN	28480	2100-3757
A6R12	0699-0517	5	1	RESISTOR 5.621K .1% .1W F TC=0+4	28480	0699-0517
A6R13	0698-3457	6	1	RESISTOR 316K 1% .125W F TC=0 ± 100	28480	0698-3457
A6R14	0757-0442	9	4	RESISTOR 10K 1% .125W F TC=0 ± 100	24546	CT4-1/8-TO-1002-F
A6R15	0757-0401	0	1	RESISTOR 100 1% .125W F TC=0 ± 100	24546	CT4-1/8-TO-101-F

Table 6-3. HP 83570A Replaceable Parts

Reference Designation	HP Part Number	C D	Qty	Description	Mfr Code	Mfr Part Number
A6R16	0698-0083	8	5	RESISTOR 1.96K 1% .125W F TC=0±100	24546	CT4-1/8-TO-1961-F
A6R17	0698-0083	8		RESISTOR 1.96K 1% .125W F TC=0±100	24546	CT4-1/8-TO-1961-F
A6R18	0698-6317	3	1	RESISTOR 500 .1% .125W F TC=0±25	03888	PME55-1/8-T9-500R-B
A6R19	0757-0280	3	3	RESISTOR 1K 1% .125W F TC=0±100	24546	CT4-1/8-TO-1001-F
A6R20	0698-8486	1	1	RESISTOR 9.84K .1% .1W F TC=0+4	28480	0698-8486
A6R21	2100-3750	9	1	RESISTOR-TRMR 20K 10% C SIDE-ADJ 17-TRN	28480	2100-3750
A6R22	0698-8479	2	1	RESISTOR 4.16K .1% .1W F TC=0+4	28480	0698-8479
A6R23	0757-0280	3		RESISTOR 1K 1% .125W F TC=0±100	24546	CT4-1/8-TO-1001-F
A6R24	0757-1094	9	1	RESISTOR 1.47K 1% .125W F TC=0±100	24546	CT4-1/8-TO-1471-F
A6R25	2100-3753	2	1	RESISTOR-TRMR 200K 10% C SIDE-ADJ 17-TRN	28480	2100-3753
A6R26	0698-6384	4	1	RESISTOR 330K 1% .125W F TC=0±25	28480	0698-6384
A6R27	0698-8489	4	2	RESISTOR 15K .1% .1W F TC=0+4	28480	0698-8489
A6R28	0698-6406	1	2	RESISTOR 8.54K .1% .1W F TC=0+4	28480	0698-6406
A6R29	0698-6406	1		RESISTOR 8.54K .1% .1W F TC=0+4	28480	0698-6406
A6R30	2100-3757	6		RESISTOR-TRMR 100 10% C SIDE-ADJ 17-TRN	28480	2100-3757
A6R31	0699-0518	6	1	RESISTOR 11.489K .1% .1W F TC=0+4	28480	0699-0518
A6R32	0698-8489	4		RESISTOR 15K .1% .1W F TC=0+4	28480	0698-8489
A6R33				NOT ASSIGNED		
A6R34	0757-0442	9		RESISTOR 10K 1% .125W F TC=0±100	24546	CT4-1/8-TO-1002-F
A6R35	0757-0470	3	1	RESISTOR 162K 1% .125W F TC=0±100	24546	CT4-1/8-TO-1623-F
A6R36	0757-0442	9		RESISTOR 10K 1% .125W F TC=0±100	24546	CT4-1/8-TO-1002-F
A6R37	0757-0274	5	1	RESISTOR 1.21K 1% .125W F TC=0±100	24546	CT4-1/8-TO-1211-F
A6R38 TO A6R41				NOT ASSIGNED		
A6R42	0698-3453	2	1	RESISTOR 196K 1% .125W F TC=0±100	24546	CT4-1/8-TO-1963-F
A6R43	0698-0083	8		RESISTOR 1.96K 1% .125W F TC=0±100	24546	CT4-1/8-TO-1961-F
A6R44	0757-0447	4	1	RESISTOR 16.2K 1% .125W F TC=0±100	24546	CT4-1/8-TO-1622-F
A6R45	2100-3732	7	1	RESISTOR-TRMR 500 10% C SIDE-ADJ 17-TRN	28480	2100-3732
A6R46	0757-0438	3	1	RESISTOR 5.11K 1% .125W F TC=0±100	24546	CT4-1/8-TO-5111-F
A6R47	0698-8825	2	1	RESISTOR 681K 1% .125W F TC=0±100	28480	0698-8825
A6R48	0698-0083	8		RESISTOR 1.96K 1% .125W F TC=0±100	24546	CT4-1/8-TO-1961-F
A6R49	0757-0421	4	2	RESISTOR 825 1% .125W F TC=0±100	24546	CT4-1/8-TO-825R-F
A6R50	0757-0421	4		RESISTOR 825 1% .125W F TC=0±100	24546	CT4-1/8-TO-825R-F
A6R51	0698-0083	8		RESISTOR 1.96K 1% .125W F TC=0±100	24546	CT4-1/8-TO-1961-F
A6R52	0757-0442	9		RESISTOR 10K 1% .125W F TC=0±100	24546	CT4-1/8-TO-1002-F
A6R53	0757-0280	3		RESISTOR 1K 1% .125W F TC=0±100	24546	CT4-1/8-TO-1001-F
A6R54	0698-7220	9	2	RESISTOR 215 1% .05W F TC=0±100	24546	C3-1/8-TO-215R-F
A6R55	0698-7220	9		RESISTOR 215 1% .05W F TC=0±100	24546	C3-1/8-TO-215R-F
A6S1	3101-0471	8	2	SWITCH-RKR DIP-RKR-ASSY 10-1A .05A 30VDC	28480	3101-0471
A6S2	3101-0471	8		SWITCH-RKR DIP-RKR-ASSY 10-1A .05A 30VDC	28480	3101-0471
A6TP1	1251-5924	1	16	CONNECTOR 16-PIN M POST TYPE	28480	1251-5924
A6TP2	1251-5924	1		CONNECTOR 16-PIN M POST TYPE	28480	1251-5924
A6TP3	1251-5924	1		CONNECTOR 16-PIN M POST TYPE	28480	1251-5924
A6TP4	1251-5924	1		CONNECTOR 16-PIN M POST TYPE	28480	1251-5924
A6TP5	1251-5924	1		CONNECTOR 16-PIN M POST TYPE	28480	1251-5924
A6TP6	1251-5924	1		CONNECTOR 16-PIN M POST TYPE	28480	1251-5924
A6TP7	1251-5924	1		CONNECTOR 16-PIN M POST TYPE	28480	1251-5924
A6TP8	1251-5924	1		CONNECTOR 16-PIN M POST TYPE	28480	1251-5924
A6TP9	1251-5924	1		CONNECTOR 16-PIN M POST TYPE	28480	1251-5924
A6TP10	1251-5924	1		CONNECTOR 16-PIN M POST TYPE	28480	1251-5924

Table 6-3. HP 83570A Replaceable Parts

Reference Designation	HP Part Number	C D	Qty	Description	Mfr Code	Mfr Part Number
A6TP11	1251-5924	1		CONNECTOR 16-PIN M POST TYPE	28480	1251-5924
A6TP12	1251-5924	1		CONNECTOR 16-PIN M POST TYPE	28480	1251-5924
A6TP13	1251-5924	1		CONNECTOR 16-PIN M POST TYPE	28480	1251-5924
A6TP14	1251-5924	1		CONNECTOR 16-PIN M POST TYPE	28480	1251-5924
A6TP15	1251-5924	1		CONNECTOR 16-PIN M POST TYPE	28480	1251-5924
A6TP16	1251-5924	1		CONNECTOR 16-PIN M POST TYPE	28480	1251-5924
A6U1	1810-0277	3	2	NETWORK-RES 10-SIP 2.2K OHM X 9	91637	CSC10A01-222G/MSP10A01
A6U2	1810-0277	3		NETWORK-RES 10-SIP 2.2K OHM X 9	91637	CSC10A01-222G/MSP10A01
A6U3	1820-2024	3	3	IC DRVR TTL LS LINE DRVR OCTL	01295	SN74LS244N
A6U4	1820-2024	3		IC DRVR TTL LS LINE DRVR OCTL	01295	SN74LS244N
A6U5	1826-0026	3	1	IC COMPARATOR PRCN TO-99 PKG	01295	LM311L
A6U6	1826-0477	8	2	IC SWITCH ANLG 8-DIP-P PKG	01295	TL610CP
A6U7	1820-2024	3		IC DRVR TTL LS LINE DRVR OCTL	01295	SN74LS244N
A6U8	1820-1730	6	4	IC FF TTL LS D-TYPE POS-EDGE-TRIG COM	01295	SN74LS273N
A6U9	1826-0684	9	2	D/A 12-BIT 18-CBRZ/SDR CMOS	24355	AD7541BD(SEL)
A6U9	1826-0797	5	2	D/A 12-BIT 18-CBRZ/SDR CMOS ALTERNATE	24355	AD7541BD(SEL)
A6U10	1826-0471	2	7	IC OP AMP LOW-DRIFT TO-99 PKG	06665	OP-07CJ SELECTED
A6U11	1826-0471	2		IC OP AMP LOW-DRIFT TO-99 PKG	06665	OP-07CJ SELECTED
A6U12	1820-1272	1	1	IC BFR TTL LS NOR QUAD 2-INP	01295	SN74LS33N
A6U13	1820-1730	6		IC FF TTL LS D-TYPE POS-EDGE-TRIG COM	01295	SN74LS273N
A6U14	1826-0471	2		IC OP AMP LOW-DRIFT TO-99 PKG	06665	OP-07CJ SELECTED
A6U15	1826-0471	2		IC OP AMP LOW-DRIFT TO-99 PKG	06665	OP-07CJ SELECTED
A6U16	1826-0471	2		IC OP AMP LOW-DRIFT TO-99 PKG	06665	OP-07CJ SELECTED
A6U17	1820-1112	8	1	IC FF TTL LS D-TYPE POS-EDGE-TRIG	01295	SN74LS74AN
A6U18	1820-1730	6		IC FF TTL LS D-TYPE POS-EDGE-TRIG COM	01295	SN74LS273N
A6U19	1826-0684	9		D/A 12-BIT 18-CBRZ/SDR CMOS	24355	AD7541BD(SEL)
A6U19	1826-0797	5		D/A 12-BIT 18-CBRZ/SDR CMOS ALTERNATE	24355	AD7541BD(SEL)
A6U20	1826-0471	2		IC OP AMP LOW-DRIFT TO-99 PKG	06665	OP-07CJ SELECTED
A6U21	1820-1211	8	1	IC GATE TTL LS EXCL-OR QUAD 2-INP	01295	SN74LS86AN
A6U22	1820-1730	6		IC FF TTL LS D-TYPE POS-EDGE-TRIG COM	01295	SN74LS273N
A6U23	1826-0330	2	1	V REF PRCN TO-46	27014	LM299H
A6U24	1826-0471	2		IC OP AMP LOW-DRIFT TO-99 PKG	06665	OP-07CJ SELECTED
A6U25	1820-1216	3	1	IC DCDR TTL LS 3-TO-8-LINE 3-INP	01295	SN74LS138N
A6U26	1826-0477	8		IC SWITCH ANLG 8-DIP-P PKG	01295	TL610CP
A6U27	1826-0512	2	1	IC V RGLTR-FXD-POS 14.4/15.6V TO-39 PKG	28480	1826-0512
A6VR1	1902-0197	1	1	DIODE-ZNR 82V 5% PD=1W IR=5UA	28480	1902-0197

Table 6-3. HP 83570A Replaceable Parts

Reference Designation	HP Part Number	C D	Qty	Description	Mfr Code	Mfr Part Number
A7	83570-60065	2	1	YO BIAS	28480	83570-60065
A7C1	0160-2055	9	13	CAPACITOR-FXD .01UF +80-20% 100VDC CER	28480	0160-2055
A7C2	0160-2055	9		CAPACITOR-FXD .01UF +80-20% 100VDC CER	28480	0160-2055
A7C3	0180-1743	2	3	CAPACITOR-FXD .1UF ± 10% 35VDC TA	56289	150D104X9035A2
A7C4	0160-3878	6	1	CAPACITOR-FXD 1000PF ± 20% 100VDC CER	28480	0160-3878
A7C5				NOT ASSIGNED		
A7C6	0160-4389	6	2	CAPACITOR-FXD 100PF ± 5PF 200VDC CER	28480	0160-4389
A7C7	0160-3879	7	1	CAPACITOR-FXD .01UF ± 20% 100VDC CER	28480	0160-3879
A7C8	0160-2055	9		CAPACITOR-FXD .01UF +80-20% 100VDC CER	28480	0160-2055
A7C9	0160-2055	9		CAPACITOR-FXD .01UF +80-20% 100VDC CER	28480	0160-2055
A7C10	0160-4389	6		CAPACITOR-FXD 100PF ± 5PF 200VDC CER	28480	0160-4389
A7C11	0160-2055	9		CAPACITOR-FXD .01UF +80-20% 100VDC CER	28480	0160-2055
A7C12	0160-2055	9		CAPACITOR-FXD .01UF +80-20% 100VDC CER	28480	0160-2055
A7C13	0160-2055	9		CAPACITOR-FXD .01UF +80-20% 100VDC CER	28480	0160-2055
A7C14	0160-2055	9		CAPACITOR-FXD .01UF +80-20% 100VDC CER	28480	0160-2055
A7C15	0160-0571	0	1	CAPACITOR-FXD 470PF ± 20% 100VDC CER	28480	0160-0571
A7C16	0160-2055	9		CAPACITOR-FXD .01UF +80-20% 100VDC CER	28480	0160-2055
A7C17	0160-2055	9		CAPACITOR-FXD .01UF +80-20% 100VDC CER	28480	0160-2055
A7C18	0160-2055	9		CAPACITOR-FXD .01UF +80-20% 100VDC CER	28480	0160-2055
A7C19	0180-0474	4	6	CAPACITOR-FXD 15UF ± 10% 20VDC TA	28480	0180-0474
A7C20	0160-2055	9		CAPACITOR-FXD .01UF +80-20% 100VDC CER	28480	0160-2055
A7C21	0180-1743	2		CAPACITOR-FXD .1UF ± 10% 35VDC TA	56289	150D104X9035A2
A7C22	0180-0474	4		CAPACITOR-FXD 15UF ± 10% 20VDC TA	28480	0180-0474
A7C23	0180-0474	4		CAPACITOR-FXD 15UF ± 10% 20VDC TA	28480	0180-0474
A7C24	0180-0474	4		CAPACITOR-FXD 15UF ± 10% 20VDC TA	28480	0180-0474
A7C25	0180-0474	4		CAPACITOR-FXD 15UF ± 10% 20VDC TA	28480	0180-0474
A7C26	0180-2617	1	3	CAPACITOR-FXD 6.8UF ± 10% 35VDC TA	25088	D6R8GS1B35K
A7C27	0180-2617	1		CAPACITOR-FXD 6.8UF ± 10% 35VDC TA	25088	D6R8GS1B35K
A7C28	0180-2617	1		CAPACITOR-FXD 6.8UF ± 10% 35VDC TA	25088	D6R8GS1B35K
A7C29	0160-2055	9		CAPACITOR-FXD .01UF +80-20% 100VDC CER	28480	0160-2055
A7C30	0180-1743	2		CAPACITOR-FXD .1UF ± 10% 35VDC TA	56289	150D104X9035A2
A7C31				NOT ASSIGNED		
A7C32	0180-0474	4		CAPACITOR-FXD 15UF ± 10% 20VDC TA	28480	0180-0474
A7C33	0160-3448	6	1	CAPACITOR-FXD 1000PF ± 10% 1KVDC CER	28480	0160-3448
A7CR1				NOT ASSIGNED		
A7CR2	1901-0518	8	1	DIODE-SM SIG SCHOTTKY	28480	1901-0518
A7L1	9100-1788	6	1	CORE-FERRITE CHOKE-WIDEBAND;IMP;>680	28480	9100-1788
A7L2	9100-1641	0	5	INDUCTOR RF-CH-MLD 240UH 5%	28480	9100-1641
A7L3	9100-1641	0		INDUCTOR RF-CH-MLD 240UH 5%	28480	9100-1641
A7L4	9100-1641	0		INDUCTOR RF-CH-MLD 240UH 5%	28480	9100-1641
A7L5	9100-1641	0		INDUCTOR RF-CH-MLD 240UH 5%	28480	9100-1641
A7L6	9100-1641	0		INDUCTOR RF-CH-MLD 240UH 5%	28480	9100-1641
A7MP1	5040-6853	4	1	EXTRACTR PC BRN	28480	5040-6853
A7MP2	5000-9043	6	1	PIN	28480	5000-9043
A7MP3	1200-0173	5	1	INSULATOR-XSTR DAP-GL	28480	1200-0173
A7MP4	1205-0011	0	1	HEAT SINK TO-5/TO-39-CS	28480	1205-0011
A7Q1	1854-0475	5	1	TRANSISTOR-DUAL NPN PD=750MW	28480	1854-0475
A7Q2				NOT ASSIGNED		
A7Q3	1854-0019	3	4	TRANSISTOR NPN SI TO-18 PD=360MW	28480	1854-0019
A7Q4	1854-0019	3		TRANSISTOR NPN SI TO-18 PD=360MW	28480	1854-0019
A7Q5	1854-0019	3		TRANSISTOR NPN SI TO-18 PD=360MW	28480	1854-0019

Table 6-3. HP 83570A Replaceable Parts

Reference Designation	HP Part Number	C D	Qty	Description	Mfr Code	Mfr Part Number
A7Q6	1853-0405	9	1	TRANSISTOR PNP SI PD=300MW FT=850MHZ	04713	2N4209
A7Q7	1854-0019	3		TRANSISTOR NPN SI TO-18 PD=360MW	28480	1854-0019
A7Q8	1854-0637	1	1	TRANSISTOR NPN 2N2219A SI TO-5 PD=800MW	01295	2N2219A
A7Q9	1854-0477	7	1	TRANSISTOR NPN 2N2222A SI TO-18 PD=500MW	04713	2N2222A
A7R1	0757-0442	9	10	RESISTOR 10K 1% .125W F TC=0±100	24546	CT4-1/8-T0-1002-F
A7R2	0757-0442	9		RESISTOR 10K 1% .125W F TC=0±100	24546	CT4-1/8-T0-1002-F
A7R3	0757-0438	3	3	RESISTOR 5.11K 1% .125W F TC=0±100	24546	CT4-1/8-T0-5111-F
A7R4	0757-0442	9		RESISTOR 10K 1% .125W F TC=0±100	24546	CT4-1/8-T0-1002-F
A7R5	0757-0442	9		RESISTOR 10K 1% .125W F TC=0±100	24546	CT4-1/8-T0-1002-F
A7R6	0698-0082	7	3	RESISTOR 464 1% .125W F TC=0±100	24546	CT4-1/8-T0-4640-F
A7R7	0757-0401	0	3	RESISTOR 100 1% .125W F TC=0±100	24546	CT4-1/8-T0-101-F
A7R8	0757-0280	3	10	RESISTOR 1K 1% .125W F TC=0±100	24546	CT4-1/8-T0-1001-F
A7R9	0698-3440	7	1	RESISTOR 196 1% .125W F TC=0±100	24546	CT4-1/8-T0-196R-F
A7R10	0698-3449	6	1	RESISTOR 28.7K 1% .125W F TC=0±100	24546	CT4-1/8-T0-2872-F
A7R11	0757-0442	9		RESISTOR 10K 1% .125W F TC=0±100	24546	CT4-1/8-T0-1002-F
A7R12	0757-0443	0	1	RESISTOR 11K 1% .125W F TC=0±100	24546	CT4-1/8-T0-1102-F
A7R13 TO A7R15				NOT ASSIGNED		
A7R16	0757-0442	9		RESISTOR 10K 1% .125W F TC=0±100	24546	CT4-1/8-T0-1002-F
A7R17	0757-0442	9		RESISTOR 10K 1% .125W F TC=0±100	24546	CT4-1/8-T0-1002-F
A7R18	0698-0083	8	4	RESISTOR 1.96K 1% .125W F TC=0±100	24546	CT4-1/8-T0-1961-F
A7R19	0698-0083	8		RESISTOR 1.96K 1% .125W F TC=0±100	24546	CT4-1/8-T0-1961-F
A7R20	0698-0083	8		RESISTOR 1.96K 1% .125W F TC=0±100	24546	CT4-1/8-T0-1961-F
A7R21	0683-4755	8	1	RESISTOR 4.7M 5% .25W CC TC=-900/+1100	01121	CB4755
A7R22	0698-0083	8		RESISTOR 1.96K 1% .125W F TC=0±100	24546	CT4-1/8-T0-1961-F
A7R23	0757-0416	7	2	RESISTOR 511 1% .125W F TC=0±100	24546	CT4-1/8-T0-511R-F
A7R24	0757-0428	1	1	RESISTOR 1.62K 1% .125W F TC=0±100	24546	CT4-1/8-T0-1621-F
A7R25	0698-3136	8	2	RESISTOR 17.8K 1% .125W F TC=0±100	24546	CT4-1/8-T0-1782-F
A7R26	2100-3611	1	2	RESISTOR-TRMR 50K 10% C SIDE-ADJ 17-TRN	28480	2100-3611
A7R27	0698-3457	6	1	RESISTOR 316K 1% .125W F TC=0±100	28480	0698-3457
A7R28	0757-0280	3		RESISTOR 1K 1% .125W F TC=0±100	24546	CT4-1/8-T0-1001-F
A7R29	0757-0280	3		RESISTOR 1K 1% .125W F TC=0±100	24546	CT4-1/8-T0-1001-F
A7R30	0698-8827	4	2	RESISTOR 1M 1% .125W F TC=0±100	28480	0698-8827
A7R31	0698-3155	1	1	RESISTOR 4.64K 1% .125W F TC=0±100	24546	CT4-1/8-T0-4641-F
A7R32				NOT ASSIGNED		
A7R33	0757-0442	9		RESISTOR 10K 1% .125W F TC=0±100	24546	CT4-1/8-T0-1002-F
A7R34	0698-0082	7		RESISTOR 464 1% .125W F TC=0±100	24546	CT4-1/8-T0-4640-F
A7R35	0757-0290	5	1	RESISTOR 6.19K 1% .125W F TC=0±100	19701	5033R-1/8-T0-6191-F
A7R36	0757-0442	9		RESISTOR 10K 1% .125W F TC=0±100	24546	CT4-1/8-T0-1002-F
A7R37	0698-8827	4		RESISTOR 1M 1% .125W F TC=0±100	28480	0698-8827
A7R38	0698-7253	8	1	RESISTOR 5.11K 1% .05W F TC=0±100	24546	C3-1/8-T0-5111-F
A7R39	0698-3160	8	2	RESISTOR 31.6K 1% .125W F TC=0±100	24546	CT4-1/8-T0-3162-F
A7R40	0757-0465	6	2	RESISTOR 100K 1% .125W F TC=0±100	24546	CT4-1/8-T0-1003-F
A7R41	0757-0420	3	1	RESISTOR 750 1% .125W F TC=0±100	24546	CT4-1/8-T0-751-F
A7R42	0698-3160	8		RESISTOR 31.6K 1% .125W F TC=0±100	24546	CT4-1/8-T0-3162-F
A7R43	0757-0439	4	1	RESISTOR 6.81K 1% .125W F TC=0±100	24546	CT4-1/8-T0-6811-F
A7R44	0698-3454	3	1	RESISTOR 215K 1% .125W F TC=0±100	24546	CT4-1/8-T0-2153-F
A7R45	0757-0280	3		RESISTOR 1K 1% .125W F TC=0±100	24546	CT4-1/8-T0-1001-F
A7R46	0757-0438	3		RESISTOR 5.11K 1% .125W F TC=0±100	24546	CT4-1/8-T0-5111-F
A7R47	2100-3749	6	1	RESISTOR-TRMR 5K 10% C SIDE-ADJ 17-TRN	28480	2100-3749
A7R48	0698-3136	8		RESISTOR 17.8K 1% .125W F TC=0±100	24546	CT4-1/8-T0-1782-F
A7R49	0757-0465	6		RESISTOR 100K 1% .125W F TC=0±100	24546	CT4-1/8-T0-1003-F
A7R50	0698-0082	7		RESISTOR 464 1% .125W F TC=0±100	24546	CT4-1/8-T0-4640-F
A7R51	0757-0416	7		RESISTOR 511 1% .125W F TC=0±100	24546	CT4-1/8-T0-511R-F

Table 6-3. HP 83570A Replaceable Parts

Reference Designation	HP Part Number	C D	Qty	Description	Mfr Code	Mfr Part Number
A7R52	0811-1675	8	1	RESISTOR 5.6 5% 2W PW TC=0±400	75042	BWH2-5R6-J
A7R53	0698-3157	3	1	RESISTOR 19.6K 1% .125W F TC=0±100	24546	CT4-1/8-T0-1962-F
A7R54	0757-0280	3		RESISTOR 1K 1% .125W F TC=0±100	24546	CT4-1/8-T0-1001-F
A7R55	0757-0458	7	1	RESISTOR 51.1K 1% .125W F TC=0±100	24546	CT4-1/8-T0-5112-F
A7R56	0757-0280	3		RESISTOR 1K 1% .125W F TC=0±100	24546	CT4-1/8-T0-1001-F
A7R57	0757-0401	0		RESISTOR 100 1% .125W F TC=0±100	24546	CT4-1/8-T0-101-F
A7R58	0757-0274	5	1	RESISTOR 1.21K 1% .125W F TC=0±100	24546	CT4-1/8-T0-1211-F
A7R59	0757-0438	3		RESISTOR 5.11K 1% .125W F TC=0±100	24546	CT4-1/8-T0-5111-F
A7R60	2100-0545	4	1	RESISTOR-TRMR 1K 10% C SIDE-ADJ 17-TRN	28480	2100-0545
A7R61	0757-0317	7	1	RESISTOR 1.33K 1% .125W F TC=0±100	24546	CT4-1/8-T0-1331-F
A7R62	0698-3442	9	1	RESISTOR 237 1% .125W F TC=0±100	24546	CT4-1/8-T0-237R-F
A7R63	0757-0280	3		RESISTOR 1K 1% .125W F TC=0±100	24546	CT4-1/8-T0-1001-F
A7R64	0757-0280	3		RESISTOR 1K 1% .125W F TC=0±100	24546	CT4-1/8-T0-1001-F
A7R65	0698-3452	1	1	RESISTOR 147K 1% .125W F TC=0±100	24546	CT4-1/8-T0-1473-F
A7R66	0757-0401	0		RESISTOR 100 1% .125W F TC=0±100	24546	CT4-1/8-T0-101-F
A7R67	0757-0280	3		RESISTOR 1K 1% .125W F TC=0±100	24546	CT4-1/8-T0-1001-F
A7R68	0757-0280	3		RESISTOR 1K 1% .125W F TC=0±100	24546	CT4-1/8-T0-1001-F
A7R69	2100-3611	1		RESISTOR-TRMR 50K 10% C SIDE-ADJ 17-TRN	28480	2100-3611
A7R70	2100-3753	2	1	RESISTOR-TRMR 200K 10% C SIDE-ADJ 17-TRN	28480	2100-3753
A7R71	0757-0442	9		RESISTOR 10K 1% .125W F TC=0±100	24546	CT4-1/8-T0-1002-F
A7RT1	0837-0085	6	1	THERMISTOR ROD 680-OHM TC=+.7%/C-DEG	28480	0837-0085
A7TP1	0360-0535	0	6	TERMINAL-TEST POINT .330IN ABOVE	28480	0360-0535
A7TP2	0360-0535	0		TERMINAL-TEST POINT .330IN ABOVE	28480	0360-0535
A7TP3	0360-0535	0		TERMINAL-TEST POINT .330IN ABOVE	28480	0360-0535
A7TP4	0360-0535	0		TERMINAL-TEST POINT .330IN ABOVE	28480	0360-0535
A7TP5	0360-0535	0		TERMINAL-TEST POINT .330IN ABOVE	28480	0360-0535
A7TP6	0360-0535	0		TERMINAL-TEST POINT .330IN ABOVE	28480	0360-0535
A7U1	1826-1349	5	3	IC OP AMP GP 8-DIP-C PKG	02187	OP-02CZ
A7U2	1826-0416	5	1	IC SWITCH ANLG QUAD 16-DIP-C PKG	27014	LF13331D
A7U3	1826-0758	8	1	IC MULTIPLIER ANLG TO-100 PKG	28480	1826-0758
A7U4	1826-0092	3	2	IC OP AMP GP DUAL TO-99 PKG	28480	1826-0092
A7U5				NOT ASSIGNED		
A7U6	1826-0180	0	1	IC TIMER TTL MONO/ASTBL	18324	NE555N
A7U7	1826-0753	3	1	IC OP AMP LOW-BIAS-H-IMPQ QUAD 14-DIP-C	04713	MC34004BL
A7U8	1826-1349	5		IC OP AMP GP 8-DIP-C PKG	02187	OP-02CZ
A7U9	1826-1349	5		IC OP AMP GP 8-DIP-C PKG	02187	OP-02CZ
A7U10	1820-1197	9	1	IC GATE TTL LS NAND QUAD 2-INP	01295	SN74LS00N
A7U11	1820-1216	3	1	IC DCDR TTL LS 3-TO-8-LINE 3-INP	01295	SN74LS138N
A7U12	1826-0092	3		IC OP AMP GP DUAL TO-99 PKG	28480	1826-0092
A7U13	1820-1202	7	1	IC GATE TTL LS NAND TPL 3-INP	01295	SN74LS10N
A7U14	1820-1196	8	1	IC FF TTL LS D-TYPE POS-EDGE-TRIG COM	01295	SN74LS174N
A7VR1	1902-0680	7	1	DIODE-ZNR 1N827 6.2V 5% DO-7 PD=.4W	04713	1N827

Table 6-3. HP 83570A Replaceable Parts

Reference Designation	HP Part Number	C D	Qty	Description	Mfr Code	Mfr Part Number
A8	83570-60070	9	1	MOTHERBOARD	28480	83570-60070
A8CR1	1901-0033	2	1	DIODE-GEN PRP 180V 200MA DO-35	9N171	1N645
A8J1	1251-4736	1	2	CONN-POST TYPE .100-PIN-SPCG 26-CONT	28480	1251-4736
A8J2	1250-0257	1	5	CONNECTOR-RF SMB M PC 50-OHM	28480	1250-0257
A8J3	1251-4736	1		CONN-POST TYPE .100-PIN-SPCG 26-CONT	28480	1251-4736
A8J4	1250-0257	1		CONNECTOR-RF SMB M PC 50-OHM	28480	1250-0257
A8J5	1250-0257	1		CONNECTOR-RF SMB M PC 50-OHM	28480	1250-0257
A8J6	1250-0257	1		CONNECTOR-RF SMB M PC 50-OHM	28480	1250-0257
A8J7	1250-0257	1		CONNECTOR-RF SMB M PC 50-OHM	28480	1250-0257
A8J8	1251-6343	0	1	CONNECTOR 18-PIN M POST TYPE	28480	1251-6343
A8MP1	1251-7481	9	2	CONNECTOR-SGL CONT QDISC-FEM	28480	1251-7481
A8MP2	0380-0884	4	2	STANDOFF-RVT-ON .156-IN-LG 4-40-THD	28480	0380-0884
A8VR1	1902-0197	1	1	DIODE-ZNR 82V 5% PD=1W IR=5UA	28480	1902-0197
A8W1	8159-0005	0	2	RESISTOR-ZERO OHMS 22 AWG LEAD DIA	28480	8159-0005
A8W2	8159-0005	0		RESISTOR-ZERO OHMS 22 AWG LEAD DIA	28480	8159-0005
A8XA3	1251-1365	6	5	CONNECTOR-PC EDGE 22-CONT/ROW 2-ROWS	28480	1251-1365
A8XA4	1251-1365	6		CONNECTOR-PC EDGE 22-CONT/ROW 2-ROWS	28480	1251-1365
A8XA5	1251-1365	6		CONNECTOR-PC EDGE 22-CONT/ROW 2-ROWS	28480	1251-1365
A8XA6	1251-1365	6		CONNECTOR-PC EDGE 22-CONT/ROW 2-ROWS	28480	1251-1365
A8XA7	1251-1365	6		CONNECTOR-PC EDGE 22-CONT/ROW 2-ROWS	28480	1251-1365
A9	5086-7315	1	1	OSCILLATOR-K/2 FET	28480	5086-7315
A9	5086-6315	9		REBUILT EXCHANGE OSCILLATOR	28480	5086-6315

Table 6-3. HP 83570A Replaceable Parts

Reference Designation	HP Part Number	C D	Qty	Description	Mfr Code	Mfr Part Number
CHASSIS-MOUNTED PARTS						
CR1	1901-0050	3	2	DIODE-SWITCHING 80V 200MA 2NS DO-35	9N171	1N4150
CR2	1901-0050	3		DIODE-SWITCHING 80V 200MA 2NS DO-35	9N171	1N4150
J1	83570-20078	3	1	BODY WAVE GUIDE	28480	83570-20078
J2	1250-0118	3	2	CONNECTOR-RF BNC FEM SGL-HOLE-FR 50-OHM	28480	1250-0118
J3	1250-0118	3		CONNECTOR-RF BNC FEM SGL-HOLE-FR 50-OHM	28480	1250-0118
J4	08694-60013	1	1	CONNECTOR ASSEMBLY	28480	08694-60013
MP1	83522-20028	5	1	WINDOW DISPLAY	28480	83522-20028
MP2	0370-3023	8	1	KNOB 3/4 JGK .25-IN-ID	28480	0370-3023
MP3	5041-1925	3	1	KEY H PWR SWEEP	28480	5041-1925
MP4	5041-1924	2	1	KEY H PWR LEVEL	28480	5041-1924
MP5	5041-1926	4	1	KEY H SLOPE	28480	5041-1926
MP6	5041-0285	6	2	KEY Q LT PIPE	28480	5041-0285
MP7	5041-0318	6	3	KEY LT PIPE Q	28480	5041-0318
MP8				NOT ASSIGNED		
MP9	83570-00012	3	1	DRESS PANEL	28480	83570-00012
MP10	83570-20068	1	1	FRONT PANEL MACH	28480	83570-20068
MP11	83525-20040	4	1	LATCH	28480	83525-20040
MP12	83570-00006	5	1	REAR PANEL	28480	83570-00006
MP13	0050-2032	9	1	METAL CASTING ALUM REAR FRAME	28480	0050-2032
MP14	7121-2380	8	1	LABEL-SERIAL NUMBER	28480	7121-2380
MP15	5040-0345	7	2	INSULATOR CONN	28480	5040-0345
MP16	1200-0043	8	1	INSULATOR-XSTR ALUMINUM	28480	1200-0043
MP17	1205-0431	8	1	HEAT SINK TO-3-CS	28480	1205-0431
MP18	83545-20015	7	1	OSC EXTR HT SINK	28480	83545-20015
MP19	83545-20028	2	1	OSC HT SINK CAP	28480	83545-20028
MP20	83570-00005	4	1	COVER-SCREEN BOX	28480	83570-00005
MP21	83570-00008	7	1	SUPPORT BRCKT	28480	83570-00008
MP22	5040-0357	1	1	FLANGE CAP PROTECTOR	28480	5040-0357
MP23	83570-20011	4	1	STRUT-RH UPR	28480	83570-20011
MP24	83570-20012	5	1	STRUT-RH LWR	28480	83570-20012
MP25	83570-20013	6	1	STRUT-LH UPR	28480	83570-20013
MP26	83570-20014	7	1	STRUT-LH LWR	28480	83570-20014
MP27	83570-20015	8	2	SHIELD	28480	83570-20015
MP28	83570-20024	9	6	SPACER-ROUND	28480	83570-20024
MP29	83570-20026	1	1	CHASSIS	28480	83570-20026
MP30	11869-20020	4	1	ALIGNMENT PIN	28480	11869-20020
MP31	0510-0089	8	1	RETAINER-RING BSC EXT .188-IN-DIA BE-CU	28480	0510-0089
MP32	83570-20079	4	1	BEZEL WAVE GDE (PROTECTIVE COVER)	28480	83570-20079
MP33	08694-60013	1	1	N-TYPE RF CONNECTOR	28480	08694-60013
Q1	1854-0080	8	1	TRANSISTOR NPN SI TO-3 PD=100W FT=3MHZ	28480	1854-0080
R1	0811-3492	1	2	RESISTOR 133 1% 12W PW TC=0±2	28480	0811-3492
W1	83570-60019	6	1	WAVEGUIDE ASSEMBLY	28480	83570-60019
W2	83570-60009	4	1	FRT PNL RIB AY	28480	83570-60009
W3	83570-60017	4	1	CX CBL AY EXT DT	28480	83570-60017
W4	83570-60016	3	1	CX CBL AY PLS-IN	28480	83570-60016
W5	83570-60015	2	1	CABLE ASSEMBLY-OSCILLATOR	28480	83570-60015
W6	83570-20017	0	1	CBL RF YIG/MULT	28480	83570-20017
W7	83570-20018	1	1	CBL CPL/OUTPUT	28480	83570-20018
W8	83570-60061	8	1	CBL AY DIG INTRF	28480	83570-60061
W9	83570-60010	7	1	CBL AY PWR	28480	83570-60010
W10	83570-60012	9	1	CBL AY COAX AM	28480	83570-60012
W11	83570-60013	0	1	CBL AY COAX FM	28480	83570-60013
W12	83570-60014	1	1	CBL AY TUNING V	28480	83570-60014
W13	83570-60021	0	1	CBL AY-DBLR INTC	28480	83570-60021

Table 6-3. HP 83570A Replaceable Parts

Reference Designation	HP Part Number	C D	Qty	Description	Mfr Code	Mfr Part Number
MISCELLANEOUS PARTS						
1	0340-0148	9	2	INSULATOR-FLG-BSHG NYLON	28480	0340-0148
2	0360-0268	6	1	TERMINAL-SLDR LUG LK-MTG FOR-#6-SCR	28480	0360-0268
3	0360-1190	5	2	TERMINAL-SLDR LUG PL-MTG FOR-#3/8-SCR	28480	0360-1190
4				NOT ASSIGNED		
5	0510-1267	6	4	RETAINER-PUSH ON TUB EXT SPR-STL OIL-DPD	04835	C 2733-040-4
6	0520-0127	6	2	SCREW-MACH 2-56 .188-IN-LG PAN-HD-POZI	00000	ORDER BY DESCRIPTION
7	0624-0099	1	12	SCREW-TPG 4-40 .375-IN-LG PAN-HD-POZI	00000	ORDER BY DESCRIPTION
8	1400-0053	4	1	CLMP-CA .187-DIA .375-WD NYL	28480	1400-0053
9	1400-1095	6	4	CLIP-FASTENER .400 X .300 X .090 HI; BE	28480	1400-1095
10	1460-1851	8	1	WIREFORM MUW BLK OXD	28480	1460-1851
11	1480-0337	5	1	PIN-ROLL .094-IN-DIA .188-IN-LG SST	28480	1480-0337
12	1600-1033	6	1	STAMPING-BE-CU CLIP-SPRING	28480	1600-1033
13	2190-0016	3	2	WASHER-LK INTL T 3/8 IN .377-IN-ID	28480	2190-0016
14	2190-0067	4	1	WASHER-LK INTL T 1/4 IN .256-IN-ID	28480	2190-0067
15	2200-0107	6	4	SCREW-MACH 4-40 .375-IN-LG PAN-HD-POZI	00000	ORDER BY DESCRIPTION
16	2200-0113	4	2	SCREW-MACH 4-40 .625-IN-LG PAN-HD-POZI	00000	ORDER BY DESCRIPTION
17	2260-0009	3	4	NUT-HEX-W/LKWR 4-40-THD .094-IN-THK	00000	ORDER BY DESCRIPTION
18	2360-0113	2	8	SCREW-MACH 6-32 .25-IN-LG PAN-HD-POZI	00000	ORDER BY DESCRIPTION
19	2360-0115	4	14	SCREW-MACH 6-32 .312-IN-LG PAN-HD-POZI	00000	ORDER BY DESCRIPTION
20				NOT ASSIGNED		
21	2360-0210	0	2	SCREW-MACH 6-32 .625-IN-LG 82 DEG	00000	ORDER BY DESCRIPTION
22	2360-0333	8	24	SCREW-MACH 6-32 .25-IN-LG 100 DEG	28480	2360-0333
23	2950-0001	8	2	NUT-HEX-DBL-CHAM 3/8-32-THD .094-IN-THK	00000	ORDER BY DESCRIPTION
24	2950-0004	1	1	NUT-HEX-DBL-CHAM 1/4-20-THD .188-IN-THK	00000	ORDER BY DESCRIPTION
25	2950-0079	0	1	NUT-HEX-DBL-CHAM 5/8-24-THD .125-IN-THK	28480	2950-0079
26	3030-0189	4	2	SCREW-SKT HD CAP 4-40 .25-IN-LG SST	00000	ORDER BY DESCRIPTION
27	3030-0349	8	8	SCREW-SKT HD CAP 4-40 .312-IN-LG SST	00000	ORDER BY DESCRIPTION
28	3050-0003	3	1	WASHER-FL NM NO. 6 .141-IN-ID .375-IN-OD	28480	3050-0003
29	3050-0227	3	4	WASHER-FL MTLC NO. 6 .149-IN-ID	28480	3050-0227
30	2190-0493	0	1	WASHER-FL MTLC 9/16 IN .625-IN-ID	28480	2190-0493
31	2190-0120	0	1	WASHER-LK INTL T 5/8 IN .64-IN-ID	28480	2190-0120
32	83525-20069	7	2	LATCH SCREW	28480	83525-20069
33				NOT ASSIGNED		
34	3050-0105	6	2	WASHER-FL MTLC NO. 4 .125-IN-ID	28480	3050-0105
35	3050-0010	2	2	WASHER-FL MTLC NO. 6 .147-IN-ID	28480	3050-0010
36	2190-0018	5	2	WASHER-LK HLCL NO. 6 .141-IN-ID	28480	2190-0018
37	2360-0236	0	1	SCREW-MACH 6-32 .812-IN-LG PAN-HD-POZI	00000	ORDER BY DESCRIPTION
38	2360-0199	4	2	SCREW-MACH 6-32 .438-IN-LG PAN-HD-POZI	00000	ORDER BY DESCRIPTION

FRONT PANEL

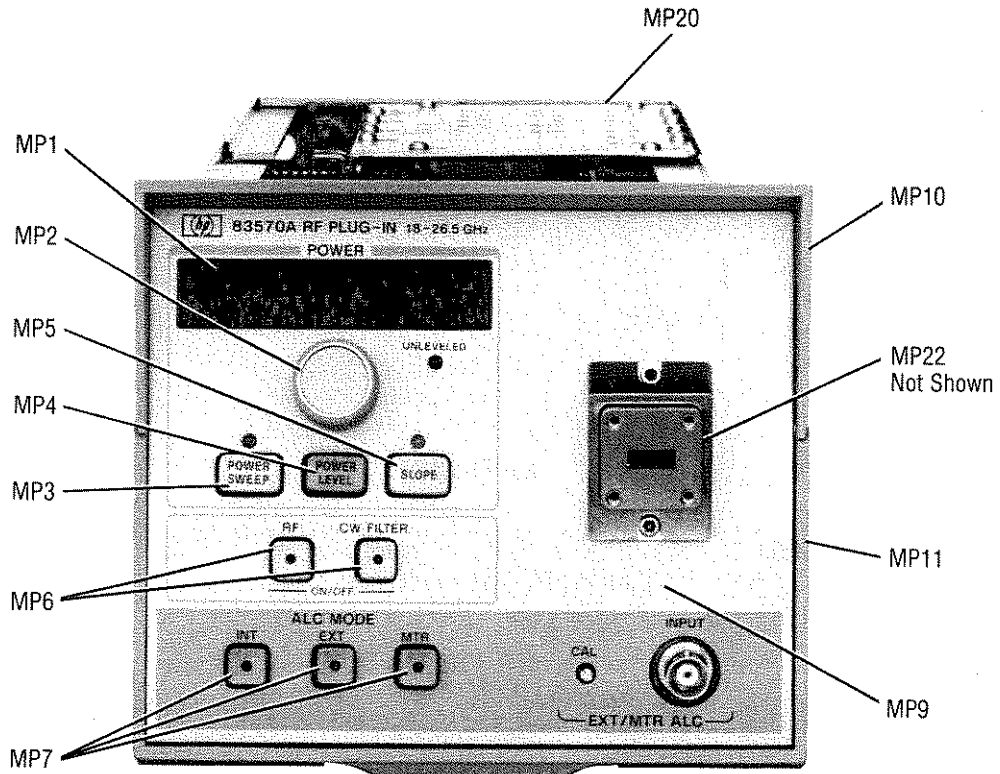

All chassis-mounted parts shown above are listed at the end of Table 6-3 (Replaceable Parts) under the column titled "CHASSIS-MOUNTED PARTS."

Figure 6-1. Chassis-Mounted Parts (1 of 3)

RIGHT SIDE

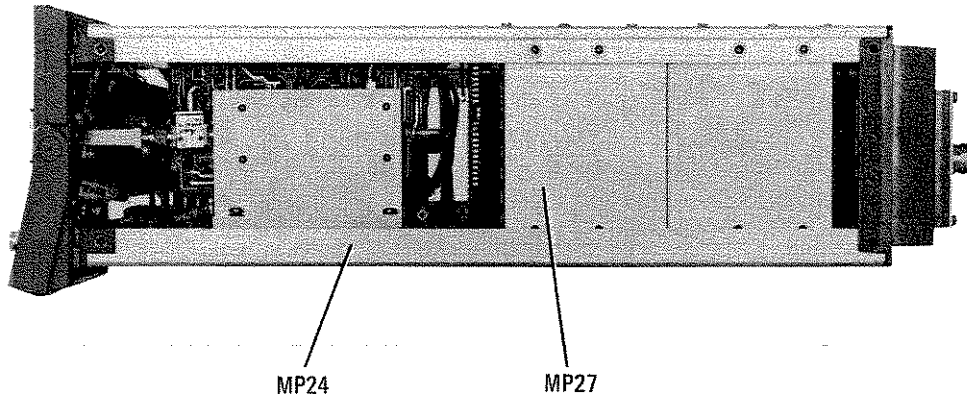

LEFT SIDE

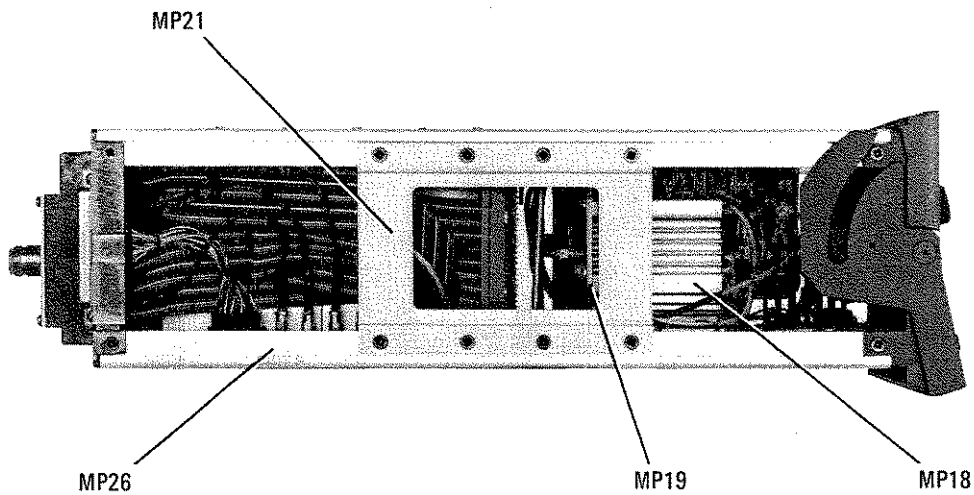

All chassis-mounted parts shown above are listed at the end of Table 6-3 (Replaceable Parts) under the column titled "CHASSIS-MOUNTED PARTS."

Figure 6-1. Chassis-Mounted Parts (2 of 3)

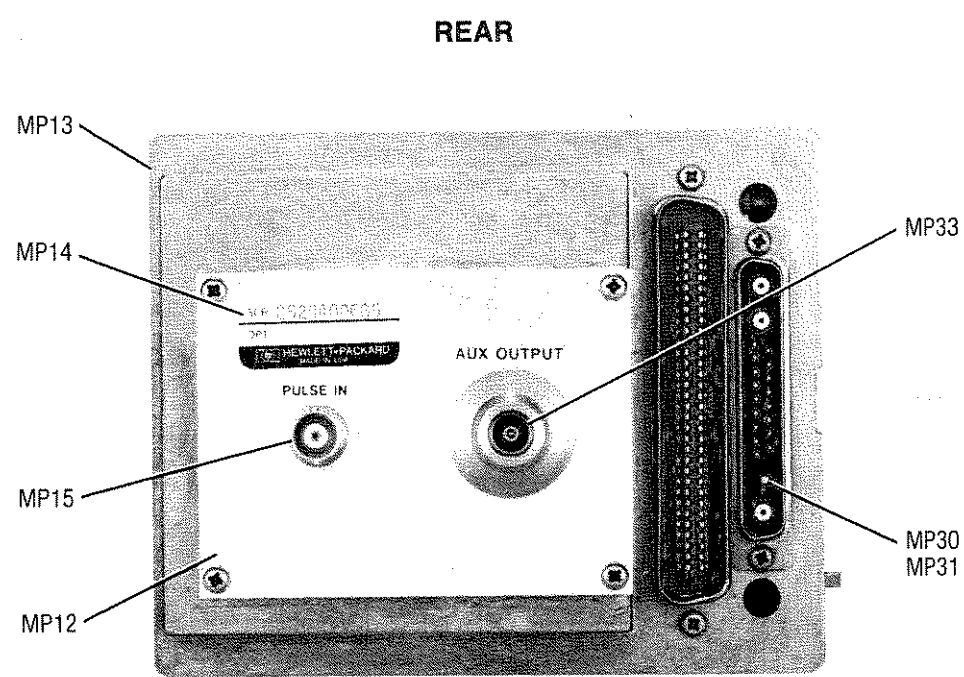
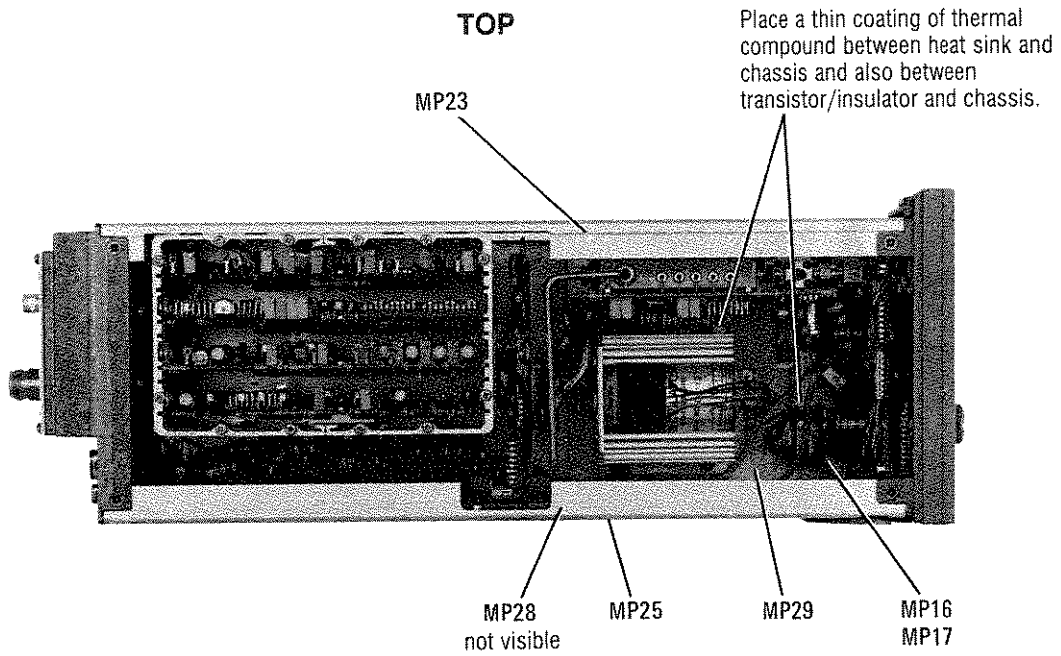

All chassis-mounted parts shown above are listed at the end of Table 6-3 (Replaceable Parts) under the column titled "CHASSIS-MOUNTED PARTS."

Figure 6-1. Chassis-Mounted Parts (3 of 3)

FRONT PANEL

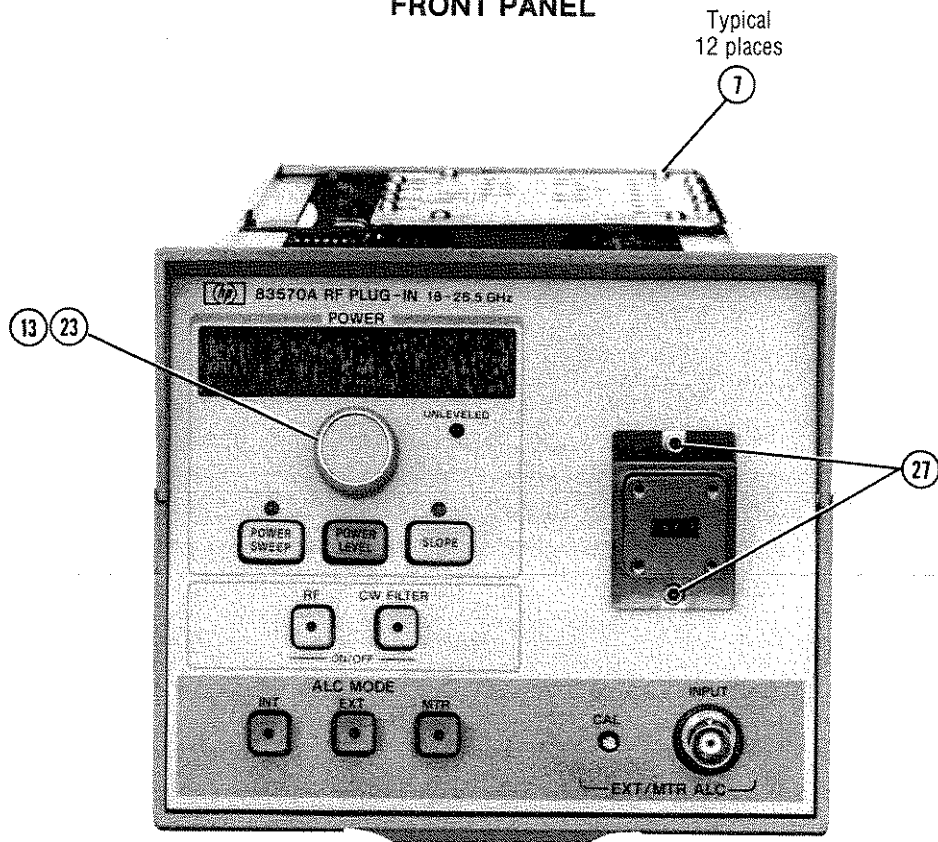

REAR VIEW OF FRONT PANEL

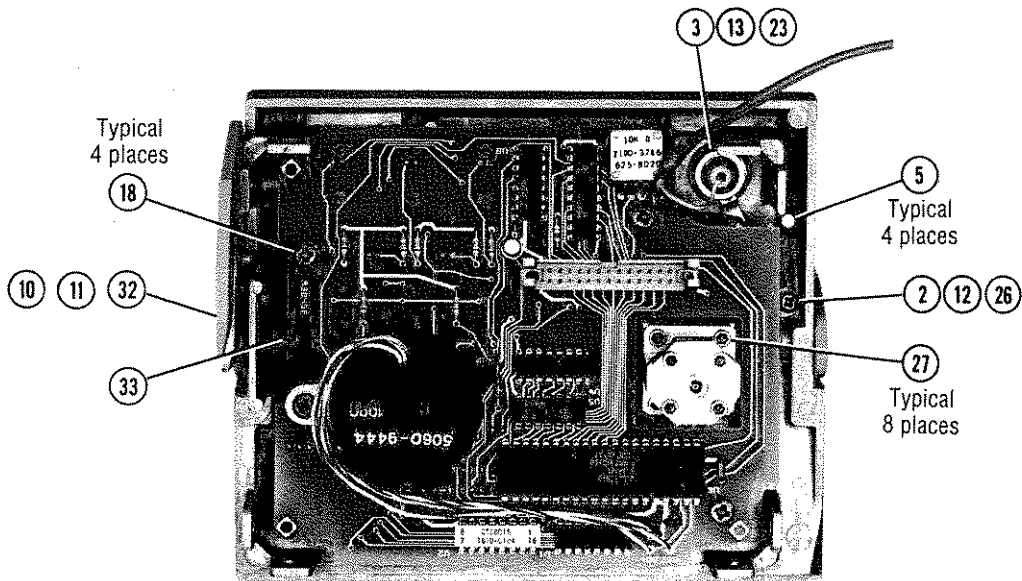

All miscellaneous parts shown above are listed at the end of Table 6-3 (Replaceable Parts) under the column titled "MISCELLANEOUS PARTS."

Figure 6-2. Miscellaneous Parts (1 of 4)

RIGHT SIDE

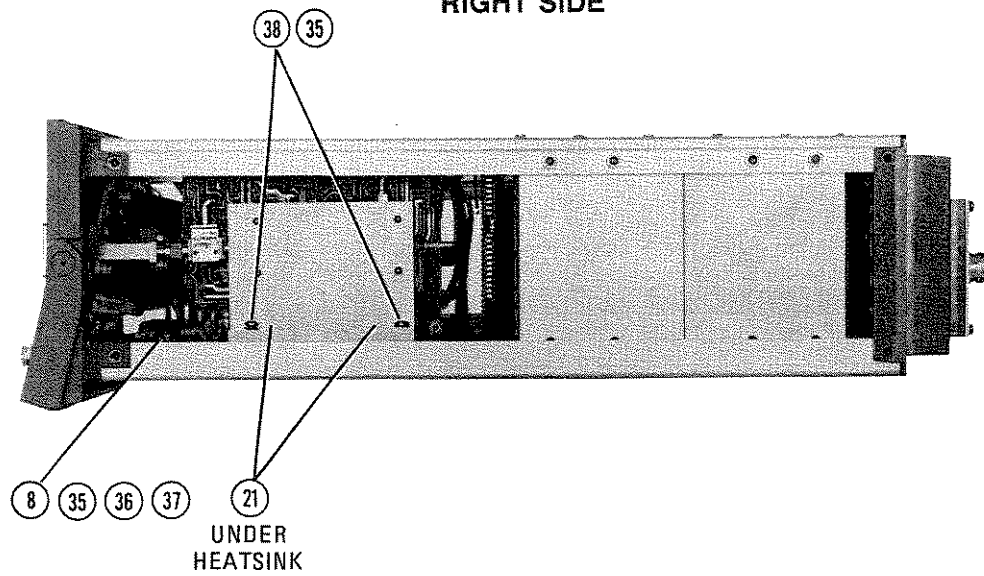

LEFT SIDE

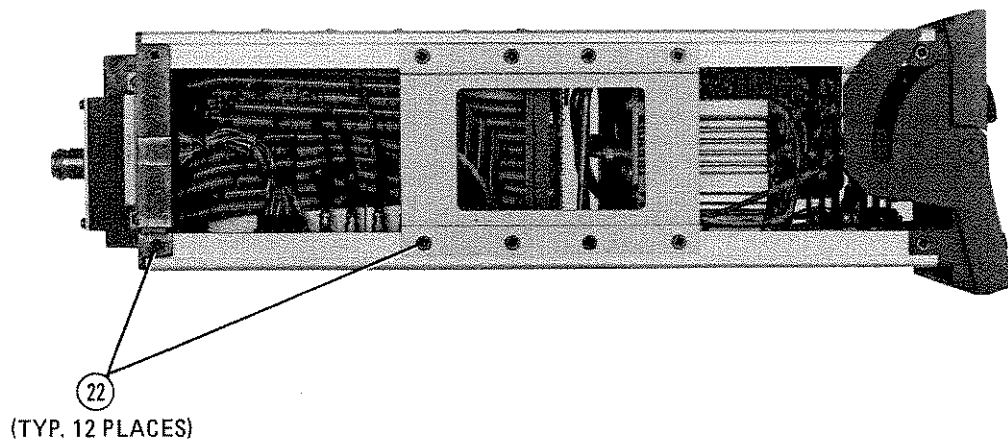

All miscellaneous parts shown above are listed at the end of Table 6-3 (Replaceable Parts) under the column titled "MISCELLANEOUS PARTS."

Figure 6-2. Miscellaneous Parts (2 of 4)

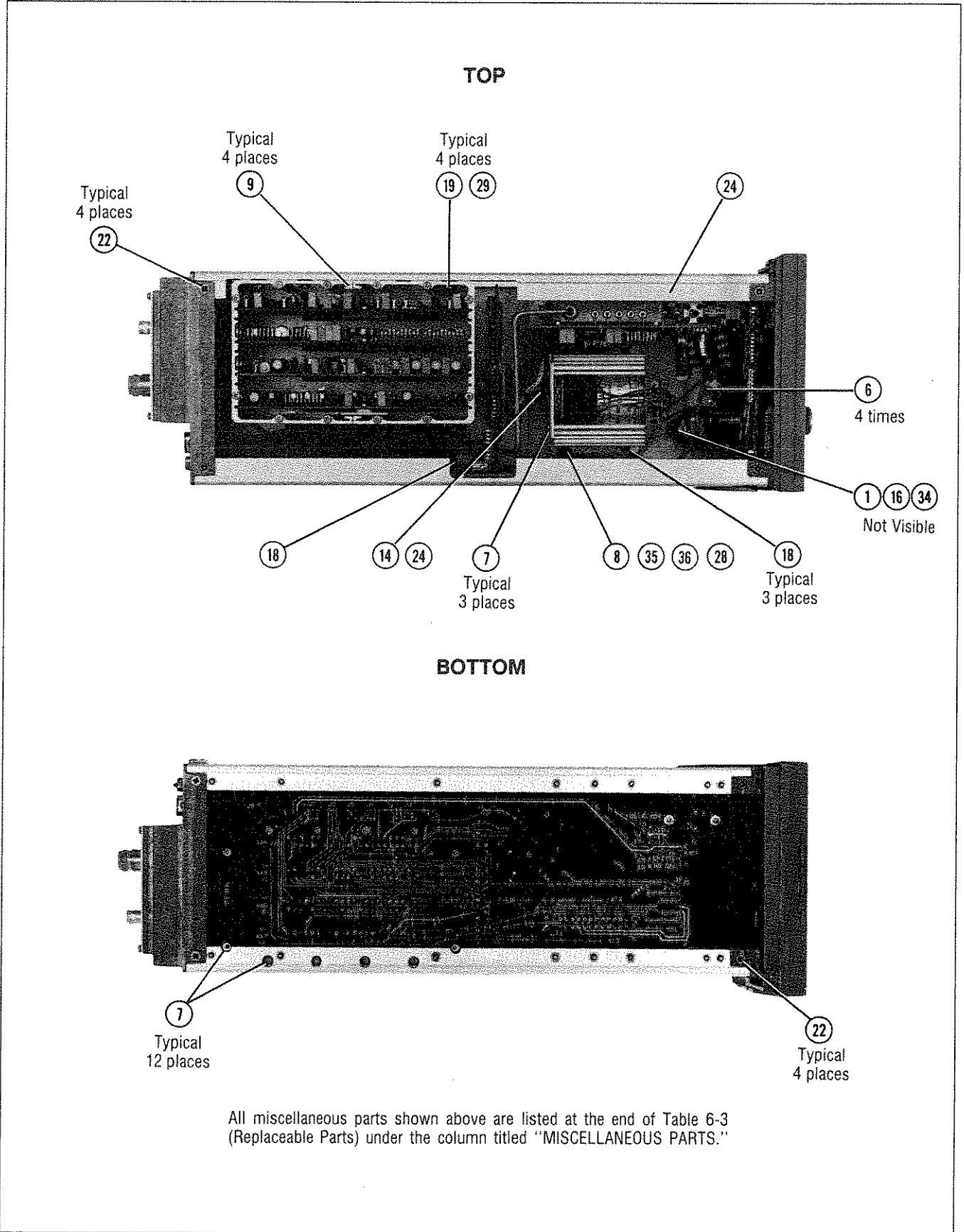
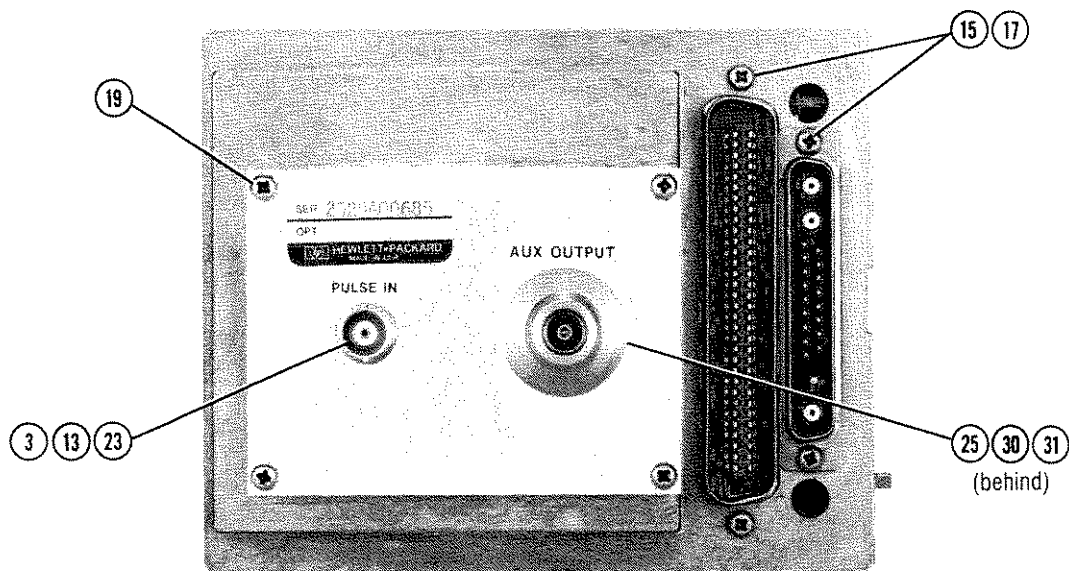

Figure 6-2. Miscellaneous Parts (3 of 4)

REAR PANEL



All miscellaneous parts shown above are listed at the end of Table 6-3 (Replaceable Parts) under the column titled "MISCELLANEOUS PARTS."

Figure 6-2. Miscellaneous Parts (4 of 4)

Section VII. Manual Backdating Changes

INTRODUCTION

This manual has been written to and applies directly to instruments with serial numbers prefixed as indicated on the title page. Earlier versions of the instrument (serial numbers prefixed lower than the ones indicated on the title page) may be slightly different in design or appearance. The purpose of this section of the manual is to document these differences.

With the information provided in this section, this manual can be corrected so that it applies to any earlier version or configuration of the instrument. Later versions of the instrument (serial numbers prefixed higher than the ones indicated on the title page) are documented in a yellow Manual Changes Supplement.

To adapt this instrument to an earlier instrument, refer to Table 7-1 and make the manual backdating changes listed opposite your instrument serial number or serial number prefix.

Table 7-2 provides a summary of changes by assembly.

For additional important information about serial number coverage, refer to INSTRUMENTS COVERED BY THE MANUAL in Section I.

Table 7-1. Manual Backdating Changes by Serial Number Prefix

Serial Prefix	Make Manual Changes
2520A	A
2440A, 2412A	A through B
2304A	A through G
2301A	A through H
2247A	A through J
2229A	A through K
2228A	A through L
2211A	A through M
2150A	A through N
2102A	A through O

CHANGE A

This change documents the deletion of a jumper to the ALC assembly, it does not change any electrical functions of the ALC.

Page 6-12, Table 6-3:

Change A4 ALC assembly to HP and Mfr. Part Number 83570-60077, CD 6.

Delete A4W6, HP and Mfr. Part Number 8159-0005, CD 0, RESISTOR-ZERO OHMS, 22 AWG LEAD DIA.

Page 8-35/8-36, Figure 8-31:

Replace Figure 8-31 with *Figure 8-31, A4 Component Locations (CHANGE A)* in this document.

A4

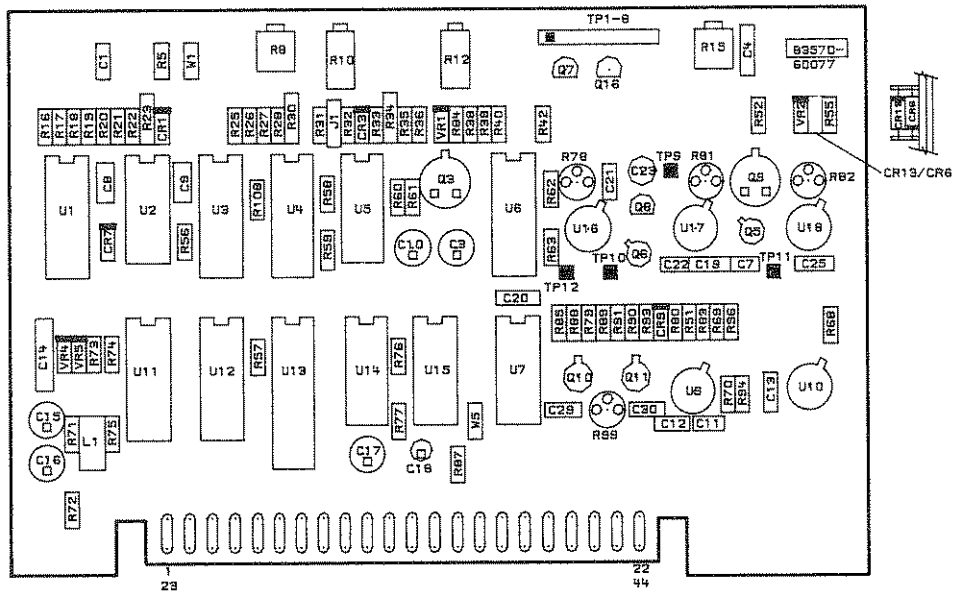

HP Part Number 83570-60077

Figure 8-31. A4 ALC Component Locations (CHANGE A)

CHANGE B

This change affects the Front Panel Casting and Dress Panel.

Page 6-27, Table 6-3:

Change MP9, Panel-Dress, to HP and Mfr. Part Number 83570-00001, CD 0.

Change MP10, Front Panel-Machine, to HP and Mfr. Part Number 83570-20010, CD 3.

Change item 5, Retainer, to HP and Mfr. Part Number 0510-1148, CD 2.

Change item 32, Screw-Latch, to HP and Mfr. Part Number 83525-20033, CD 5.

CHANGE C

This change affects the front panel board.

Page 6-6, Table 6-3:

Change A1 part number to 83570-60008, CD 3.

Delete A1C4, 0160-3879, CD 7, CAPACITOR-FXD .01UF \pm 20% 100VDC CER, Mfr. Code 28480,
Mfr. Part Number 0160-3879.

Page 8-32, Figure 8-12b:

Replace with *Figure 8-12b, A1 Component Location Diagram Circuit Side (CHANGE C)* from this Backdating Section.

Page 8-35/8-36, Figure 8-14:

On the A1 Front Panel Schematic Diagram, change part number in upper left hand corner from 83570-60071 to 83570-60008.

Replace the Block A Keyboard/Display Interface and Block G External Leveled Power Calibration Control with *P/O Figure 8-14, A1 Front Panel Schematic (CHANGE C)* from this Manual Backdating section.

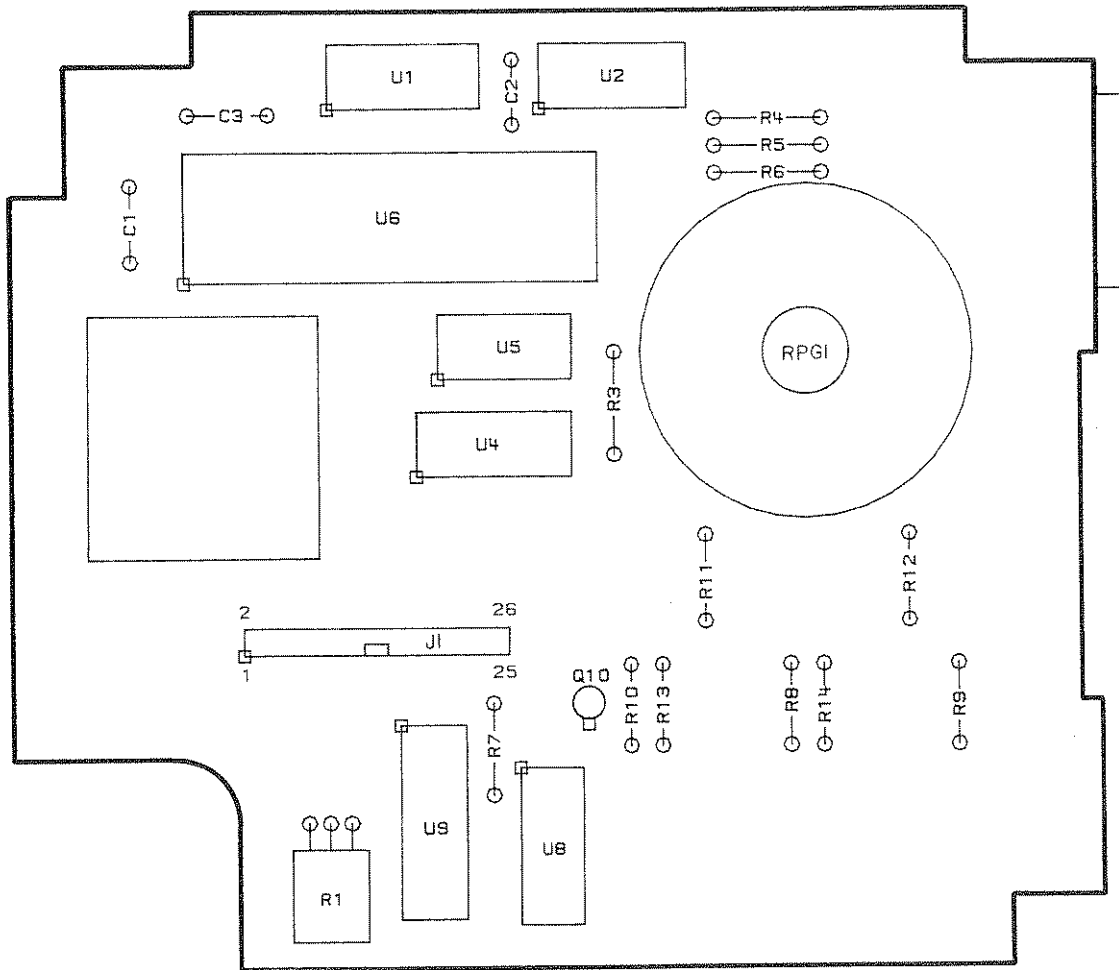

HP Part Number 83570-60008

Figure 8-12b. A1 Component Location Diagram Circuit Side (CHANGE C)

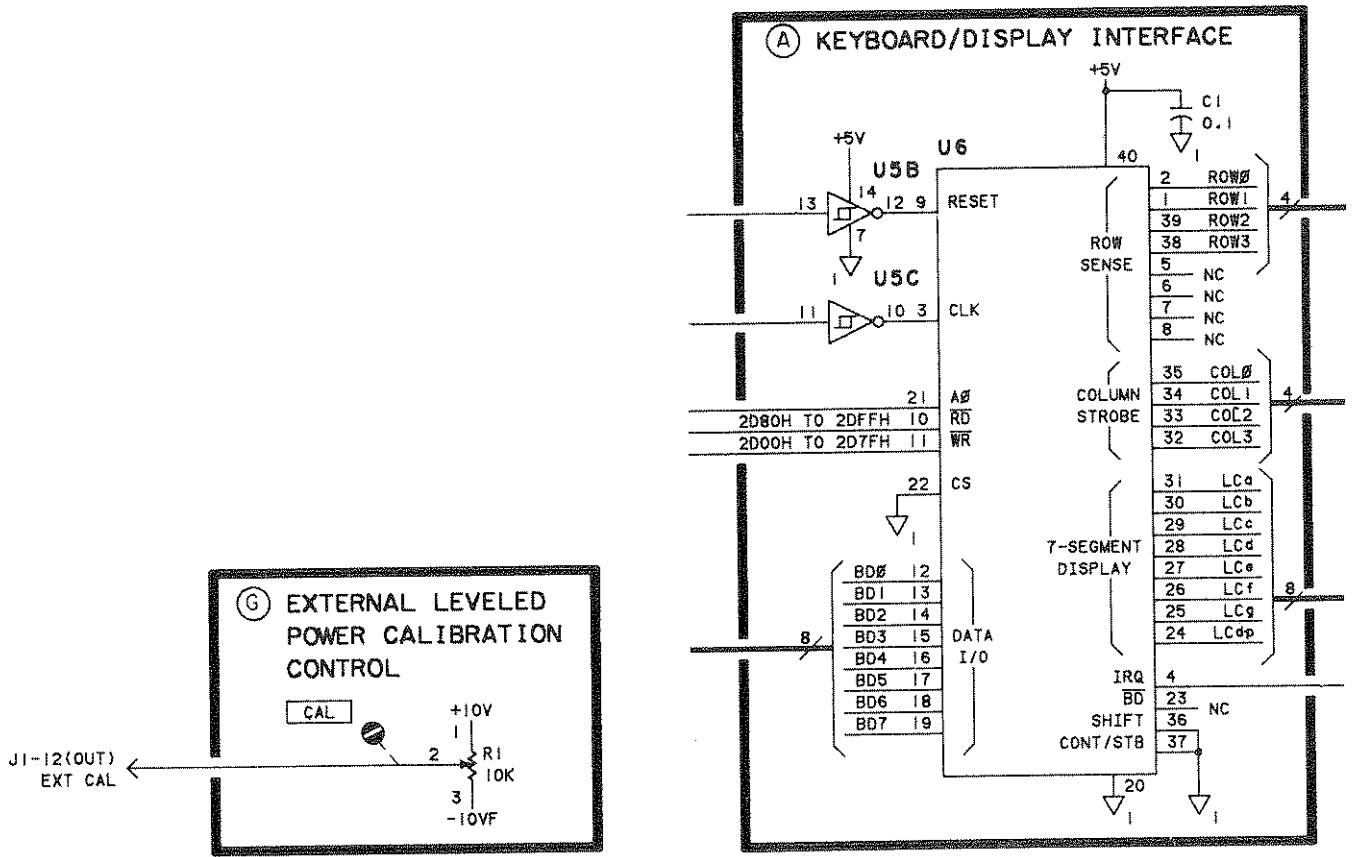

Figure 8-14. P/O A1 Front Panel Schematic (CHANGE C)

CHANGE D

This change affects the RF Plug-In compatibility with the HP 8510 Network Analyzer.

Page 6-11, Table 6-3:

Change A3 to 83525-60068, CD 0, DIGITAL INTERFACE ASSSEMBLY (does not include A3U1 and A3U2.)

Change A3U1 part number to 5081-8176, CD 4.

Change A3U2 to part number 5081-8177, CD 5.

CHANGE E

This change affects the ALC board.

Page 1-2, Table 1-1 (page 5 of 5), Note 5:

Replace with the following: "Use the HP 432A/B/C power meter. Sweep duration \geq 50 seconds.

Page 1-6, under **Power Meters and Crystal Detectors**:

Replace the first sentence with the following: "The RF output can be externally leveled using the HP 432A/B/C power meter or negative polarity output crystal detectors."

Add the following note below the paragraph: **NOTE: The HP 435A and 436A power meters should not be used in HP 8350/83570A external leveling systems."**

Page 3-13:

Under **OPERATOR'S CHECKS**, delete the following: "For power meter leveling (**ALC MODE [MTR]**), the power meter is used in conjunction with the internal leveling loop. Low frequency variations are handled by the power meter, and high frequency variations are handled by the internal leveling loop."

Pages 5-22 and 5-23, Paragraph 5-6, ALC Adjustment:

Replace the **PROCEDURE** with **5-6. ALC ADJUSTMENT (CHANGE E)** from this Manual Backdating Section

Pages 5-29 and 5-30, Paragraph 5-8, **POWER CALIBRATION**:

Replace the **PROCEDURE** with **5-8. POWER CALIBRATION (CHANGE E)** from this Manual Backdating section

Between Pages 5-30 and 5-31:

Add the adjustment paragraph **5-8a. POWER METER LEVELING (CHANGE E)** from this Manual Backdating section between adjustments **5-8** and **5-9**.

CHANGE E (Cont'd)

Page 5-31, Paragraph 5-9, **ALC GAIN ADJUSTMENT:**

Replace all reference to A4R15 with A4R11.

In **DESCRIPTION**, change A4U9 to A4U11.

Replace Figure 5-26 with *Figure 5-26, ALC Gain Adjustment Location (Change E)* from this Manual Backdating section.

Page 6-12, *Replaceable Parts List:*

Replace the parts list for the A4 Assembly with **A4 Replaceable Parts (CHANGE E)** from this Manual Backdating section.

Page 8-65 through 8-90, **A4 AUTOMATIC LEVELING CONTROL (ALC), CIRCUIT DESCRIPTION:**

Replace pages 8-65 through 8-90 together with associated figures with **A4 ALC CIRCUIT DESCRIPTION AND TROUBLESHOOTING (CHANGE E)** from this Manual Backdating section.

Page 8-85/8-86, Figure 8-31:

Replace Figure 8-31 with *Figure 8-31, A4 Component Locations Diagram (Change E)* from this Manual Backdating section.

Page 8-89/8-90, Figure 8-33:

Replace Figure 8-33 with *Figure 8-33, A4 Schematic Diagram (Change E)* from this Manual Backdating section.

5-6. ALC Adjustment (Change E)

PROCEDURE

NOTE: Turn AC power OFF when removing or installing PC boards.

NOTE: This procedure assumes taht A3S1 is set to the factory set position.

1. Place A4 assembly on an extender board. Sweep the full range of the plug-in at any leveled power.
2. Float the ground on the digital voltmeter and measure the voltage between A4TP12 and A4TP14 (Figure 5-15). Adjust A4R47 OFS 1 (offset 1) for $0.000V \pm 0.001V$.

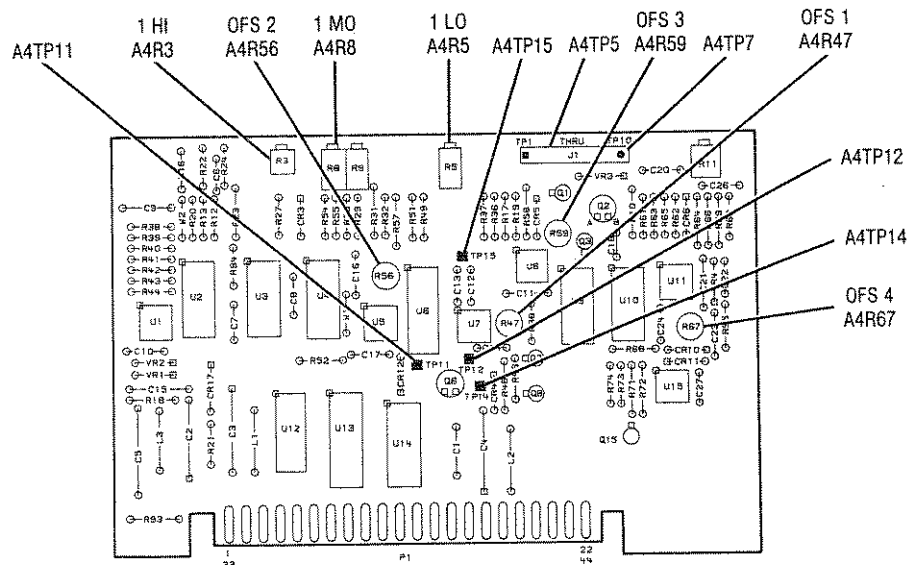

HP Part Number 83570-60067

Figure 5-15. ALC Adjustment Location

5-6. ALC Adjustment (Cont'd)

3. Connect DVM between A4TP12 and A4TP15 (floating ground). Adjust AR59 OFS 3 (offset 3) for $0.000V \pm 0.001V$.
4. Attach jumper from A4TP11 to ground. Connect DVM to A4TP5 (reference to ground). Adjust A4R56 OFS 2 (offset 2) for $0.000V \pm 0.001V$. Remove jumper.
5. Press HP 8350 front panel [CW] and set frequency to 18 GHz. Ensure that the power is leveled (UNLEVELED light off). If it isn't, adjust CW to some leveled frequency. Connect DVM to A4TP7 and adjust A4R67 OFS 4 (offset 4) for $0.000V \pm 0.001V$.
6. Turn instrument [LINE] power to instrument. Connect power meter sensor to RF OUTPUT.
7. Press HP 8350 [CW]. Enter a CW frequency of 18 GHz. Set POWER for plug-in front panel reading of -1 dBm. Adjust A4R5 "1 LO" for an RF OUTPUT power of -1 dBm ± 0.1 dB.
8. Set POWER for plug-in front panel reading of $+5$ dBm ± 0.1 dB. Adjust A4R8 "1 MD" for an RF OUTPUT power of $+5$ dBm ± 0.1 dB.
9. Iterate steps 8 and 9 until both low and midpower ranges are calibrated.
10. Set POWER for plug-in front panel reading of $+10$ dB. Adjust A4R3 "1 HI" for an RF OUTPUT power of $+10$ dBm ± 0.1 dB. This roughly calibrates the RF power. Fine calibration is documented in a later procedure.

5-8. Power Calibration (Change E)

NOTE: Complete adjustment of the leveling loop requires several procedures to be performed in the order prescribed, from Paragraph 5-6 through 5-9. Deviation from this routine may cause improper leveling and/or flatness problems.

DESCRIPTION

Power is calibrated at a CW frequency which falls in the middle of the power variation range. Adjustments are made at three breakpoints over the leveled power range: -1 to $+5$ dBm, and $+5$ dBm to $+10$ dBm.

EQUIPMENT

Power Meter	HP 436A
Power Sensor	HP 8485A
Adapter	HP K281C

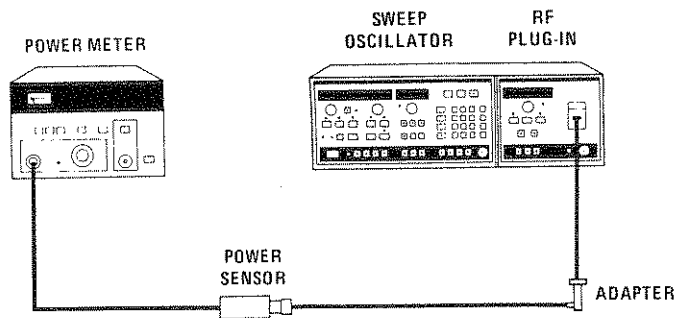

Figure 5-23. Power Calibration Test Setup

5-8. Power Calibration (Change E) (Cont'd)

PROCEDURE

NOTE: This procedure assumes that A3S1 is set to the factory set position.

1. Connect equipment as shown in Figure 5-23. Ensure HP 8350 [**L** **MOD**] is off. Select HP 8350 [**MAN**] sweep. Manually sweep through the band and select a frequency where the power is approximately in the center of the power variation range. Select [**CW**] at that frequency.
2. Set power for a front panel indication of -1 dBm. Adjust "1 LO" (A4R5) for a power meter reading of -1 dBm ± 0.1 dB.
3. Set power for front panel indication of $+5$ dBm. Adjust "1 MD" (A4R8) for a power meter indication of $+5$ dBm ± 0.1 dB.
4. Recheck -1 dBm level and readjust if needed.
5. Set power for front panel indication of $+10$ dBm. Adjust "1 HI" (A4R3) for a power meter reading of $+10$ dBm ± 0.1 dB.
6. Step the RF power in 1 dB intervals from -1 to $+10$ dBm. The power meter reading should match the front panel power setting within ± 0.2 dB, typically.

5-8a. Power Meter Leveling Calibration (Change E)

NOTE: Complete adjustment of the leveling loop for Power Meter leveling requires several procedures to be performed in the order prescribed from Paragraph 5-6 through 5-9. Deviation from this routine may cause improper leveling and/or flatness problems.

DESCRIPTION

Power Meter leveling gain potentiometer A4R9 (PM) calibrates loop gain to full-scale deflection of the leveling meter.

EQUIPMENT

Sweep Oscillator	HP 8350
Power Meter	HP 432A
Thermistor Mount	HP K486A
10 dB Attenuator	HP 8349C Option 010

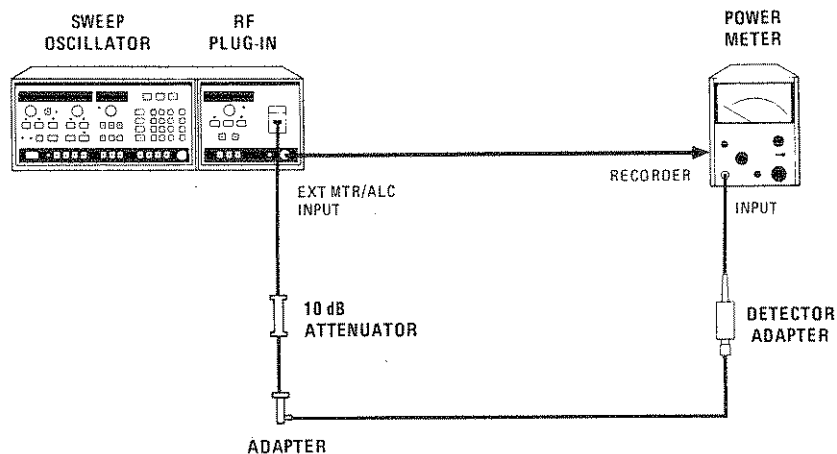

Figure A. Power Meter Leveling Adjustment Setup

PROCEDURE

NOTE: If, during the following procedure, ALC loop oscillations occur, reduce loop gain by adjusting A4R11 counterclockwise. This adjustment will be set in the next procedure.

1. Connect equipment as shown in Figure A. Ensure HP 8350 [\square MOD] is off. Press [CW] and select a frequency at midband.
2. Set HP 83570A POWER LEVEL to +5 dBm. Set Power Meter RANGE switch to 0. Adjust HP 83570A POWER LEVEL, if necessary, to obtain a meter reading of -5 dBm.
3. Press HP 83570A [MTR] ALC mode. Adjust HP 83570A front panel CAL knob to return the power meter needle to its previous position at -5 dBm.
4. Increase the HP 83570A POWER LEVEL by exactly 5.0 dBm. Adjust A4R9 "PM" (Figure 5-26) for a meter needle reading of 0 (HP 83570A front panel indication should be approximate +10 dBm).
5. Iterate between power level settings of +5 and +10 dBm adjusting the CAL knob and A4R9 respectively, until no further adjustment is necessary.

A4

A4R11 (GAIN)

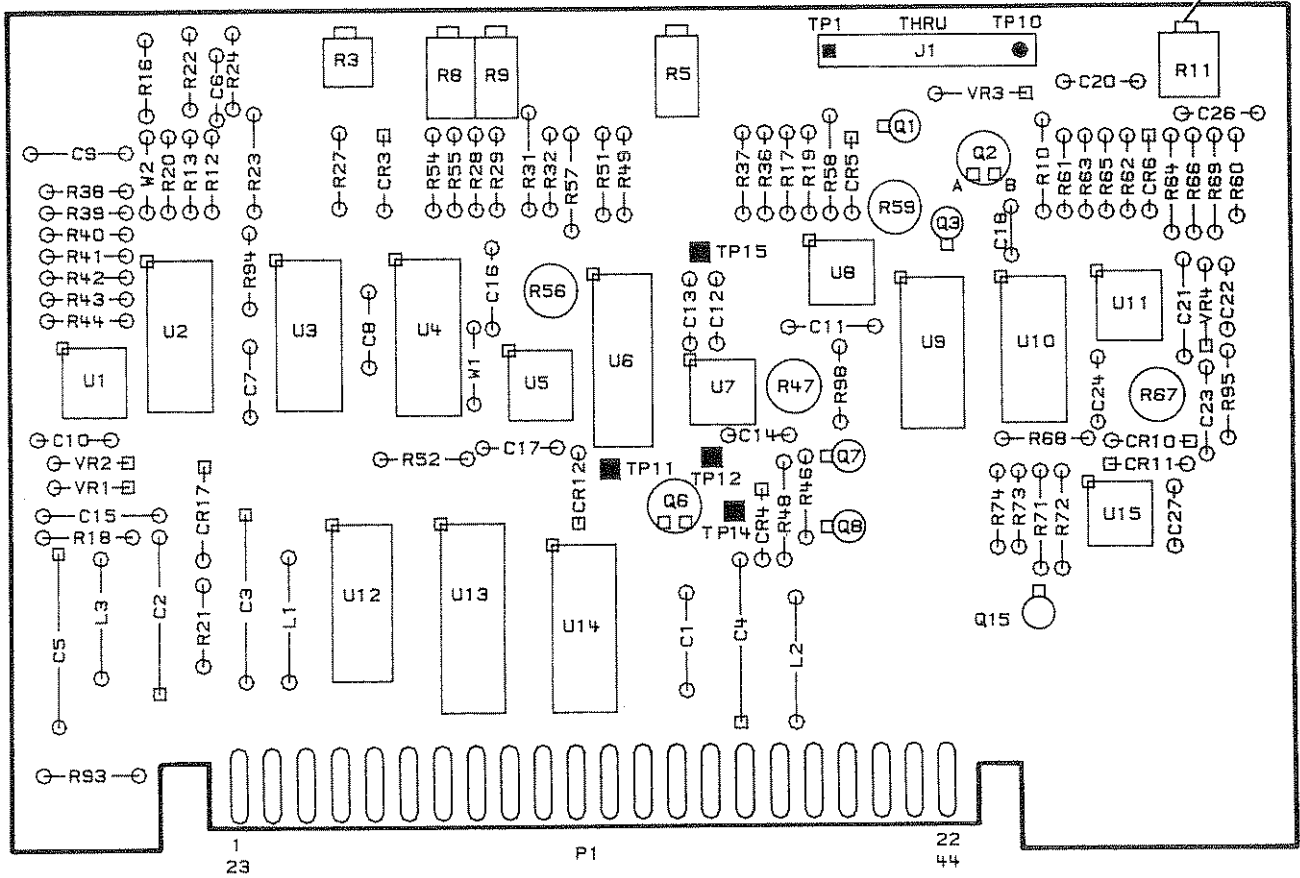

HP Part Number 83570-60067

Figure 5-26. ALC Gain Adjustment Location (Change E)

A4 Replaceable Parts (Change E)

Reference Designation	HP Part Number	C D	Qty	Description	Mfr Code	Mfr Part Number
A4	83570-60067	8	1	BOARD ASSEMBLY-ALC	28480	83570-60067
A4C1	0160-0127	2		CAPACITOR-FXD 1UF ±20% 25VDC CER	28480	0160-0127
A4C2	0180-0374	3	4	CAPACITOR-FXD 10UF ±10% 20VDC TA	56289	150D106X9020B2
A4C3	0180-0374	3		CAPACITOR-FXD 10UF ±10% 20VDC TA	56289	150D106X9020B2
A4C4	0180-0374	3		CAPACITOR-FXD 10UF ±10% 20VDC TA	56289	150D106X9020B2
A4C5	0180-0374	3		CAPACITOR-FXD 10UF ±10% 20VDC TA	56289	150D106X9020B2
A4C6	0160-3879	7		CAPACITOR-FXD .01UF ±20% 100VD CER	28480	0160-3879
A4C7	0160-4084	8		CAPACITOR-FXD .1UF ±20% 50VDC CER	28480	0160-4084
A4C8	0160-4084	8		CAPACITOR-FXD .1UF ±20% 50VDC CER	28480	0160-4084
A4C9	0160-3821	9	1	CAPACITOR-FXD .33UF ±20% 50VDC CER	28480	0160-3821
A4C10	0160-3879	7		CAPACITOR-FXD .01UF ±20% 100VD CER	28480	0160-3879
A4C11	0160-3879	7		CAPACITOR-FXD .01UF ±20% 100VDC CER	28480	0160-3879
A4C12	0160-4084	8		CAPACITOR-FXD .1UF ±20% 50VDC CER	28480	0160-4084
A4C13	0160-4084	8		CAPACITOR-FXD .1UF ±20% 50VDC CER	28480	0160-4084
A4C14	0160-3874	2	3	CAPACITOR-FXD 10PF ±.5PF 200VDC CER	28480	0160-3874
A4C15	0160-0127	2		CAPACITOR-FXD 1UF ±20% 25VDC CER	28480	0160-0127
A4C16	0160-4084	8		CAPACITOR-FXD .1UF ±20% 50VDC CER	28480	0160-4084
A4C17	0160-4084	8		CAPACITOR-FXD .1UF ±20% 50VDC CER	28480	0160-4084
A4C18	0160-0570	9	1	CAPACITOR-FXD 220PF ±20% 100VDC CER	20932	5024EM100RD221M
A4C19				NOT ASSIGNED		
A4C20	0160-0574	3	3	CAPACITOR-FXD .022UF ±20% 100VDC CER	28480	0160-0574
A4C21	0160-0128	3	1	CAPACITOR-FXD 2.2UF ±20% 50VDC CER	28480	0160-0128
A4C22	0160-3534	1	1	CAPACITOR-FXD 510PF ±5% 100VDC MICA	28480	0160-3534
A4C23	0160-4084	8		CAPACITOR-FXD .1UF ±20% 50VDC CER	28480	0160-4084
A4C24	0160-4084	8		CAPACITOR-FXD .1UF ±20% 50VDC CER	28480	0160-4084
A4C25				NOT ASSIGNED		
A4C26	0160-4389	6	1	CAPACITOR-FXD 100PF ±5PF 200VDC CER	28480	0160-4389
A4C27	0160-4084	8		CAPACITOR-FXD .1UF ±20% 50VDC CER	28480	0160-4084
A4C28-				NOT ASSIGNED		
A4C34				NOT ASSIGNED		
A4CR1				NOT ASSIGNED		
A4CR2				NOT ASSIGNED		
A4CR3	1901-1098	1	10	DIODE-SWITCHING 1N4150 50V 200MA 4NS	0004G	1N4150
A4CR4	1901-0535	9		DIODE-SWITCHING 1N4150 50V 200MA 4NS	0004G	1N4150
A4CR5	1901-1098	1		DIODE-SWITCHING 1N4150 50V 200MA 4NS	0004G	1N4150
A4CR6	1901-1098	1		DIODE-SWITCHING 1N4150 50V 200MA 4NS	0004G	1N4150
A4CR7-				NOT ASSIGNED		
A4CR9				NOT ASSIGNED		
A4CR10	1901-0050	3		DIODE-SWITCHING 80V 200MA 2NS DO-35	28480	1901-0050
A4CR11				NOT ASSIGNED		
A4CR12	1901-0535	9	4	DIODE-SM SIG SCHOTTKY	28480	1901-0535
A4CR13-				NOT ASSIGNED		
A4CR16				DIODE-SM SIG SCHOTTKY	28480	1901-0518
A4CR17	1901-0518	8		SEE A4TP1-TP7		
A4J1	1251-4932	9		CONNECTOR-SGL CONT SKT .021-IN-BSC-SZ	28480	1251-4932
A4J2						
A4L1	9140-0210	1	3	INDUCTOR RF-CH-MLD 100UH 5% .166DX.385LG	28480	9140-0210
A4L2	9140-0210	1		INDUCTOR RF-CH-MLD 100UH 5% .166DX.385LG	28480	9140-0210
A4L3	9140-0210	1		INDUCTOR RF-CH-MLD 100UH 5% .166DX.385LG	28480	9140-0210
A4MP1	5040-6848	7	1	EXTRACTOR-YELLOW	28480	5040-6848
A4MP2	5000-9043	6	4	PIN-P.C. BOARD EXTRACTOR	28480	5000-9043
A4MP3	8159-0005	0		JUMPER-WIRE 22 AWG-W PVC 1X22 80C	28480	8159-0005

A4 Replaceable Parts (Change E)

Reference Designation	HP Part Number	C D	Qty	Description	Mfr Code	Mfr Part Number
A4Q1	1855-0420	2	1	TRANSISTOR J-FET 2N4391 N-CHAN DMODE	01295	2N4391
A4Q2	1854-0295	7	2	TRANSISTOR-DUAL NPN PD=400MW	28480	1854-0295
A4Q3	1855-0414	4	1	TRANSISTOR J-FET 2N4393 N-CHAN D-MODE	04713	2N4393
A4Q4				NOT ASSIGNED		
A4Q5				NOT ASSIGNED		
A4Q6	1854-0295	7		TRANSISTOR-DUAL NPN PD=400MW	28480	1854-0295
A4Q7	1855-0423	5		TRANSISTOR MOSFET N-CHAN E-MODE	17856	VN10KM
A4Q8	1855-0423	5		TRANSISTOR MOSFET N-CHAN E-MODE	17856	VN10KM
A4Q9				NOT ASSIGNED		
A4Q10				NOT ASSIGNED		
A4Q11				NOT ASSIGNED		
A4Q12				NOT ASSIGNED		
A4Q13				NOT ASSIGNED		
A4Q14				NOT ASSIGNED		
A4Q15	1855-0423	5		TRANSISTOR MOSFET N-CHAN E-MODE	17856	VN10KM
A4R1				NOT ASSIGNED		
A4R2				NOT ASSIGNED		
A4R3	2100-2516	3	1	RESISTOR-TRMR 100K 10% C SIDE-ADJ 1-TRN	32997	3329W-1-104
A4R4				NOT ASSIGNED		
A4R5	2100-3611	1	9	RESISTOR-TRMR 50K 10% C SIDE-ADJ 17-TRN	32997	3292X-1-503
A4R6				NOT ASSIGNED		
A4R7				NOT ASSIGNED		
A4R8	2100-0670	6	1	RESISTOR-TRMR 10K 10% C SIDE-ADJ 17-TRN	32997	3292X-1-103
A4R9	2100-3749	6		RESISTOR-TRMR 5K 10% C SIDE-ADJ 17-TRN	28480	2100-3749
A4R10	0757-0416	7	5	RESISTOR 511 1% .125W F TC=0±100	24546	C4-1/8-T0-511R-F
A4R11	2100-2489	9	1	RESISTOR-TRMR 5K 5% C SIDE-ADJ 1-TRN	30983	ET50X502
A4R12	0698-7257	2		RESISTOR 7.5K 1% .05W F TC=0±100	24546	C3-1/8-T0-7501-G
A4R13	0698-7258	3		RESISTOR 8.25K 1% .05W F TC=0±100	24546	C3-1/8-T0-8251-G
A4R14				NOT ASSIGNED		
A4R15				NOT ASSIGNED		
A4R16	0698-7273	2		RESISTOR 34.8K 1% .05W F TC=0±100	24546	C3-1/8-T0-3482-G
A4R17	0698-7253	8		RESISTOR 5.11K 1% .05W F TC=0±100	24546	C3-1/8-T0-5111-G
A4R18	0698-7268	5	1	RESISTOR 21.5K 1% .05W F TC=0±100	24546	C3-1/8-T0-2152-G
A4R19	0698-7260	7		RESISTOR 10K 1% .05W F TC=0±100	24546	C3-1/8-T0-1002-G
A4R20	0698-7257	2	1	RESISTOR 7.5K 1% .05W F TC=0±100	24546	C3-1/8-T0-7501-G
A4R21	0698-7274	3	2	RESISTOR 38.3K 1% .05W F TC=0±100	24546	C3-1/8-T0-3832-G
A4R22	0698-7261	8	1	RESISTOR 11K 1% .05W F TC=0±100	24546	C3-1/8-T0-1102-G
A4R23	0757-0464	5	1	RESISTOR 90.9K 1% .125W F TC=0±100	24546	C4-1/8-T0-9092-F
A4R24	0698-7264	1	1	RESISTOR 14.7K 1% .05W F TC=0±100	24546	C3-1/8-T0-1472-G
A4R25				NOT ASSIGNED		
A4R26				NOT ASSIGNED		
A4R27	0698-7260	7		RESISTOR 10K 1% .05W F TC=0±100	24546	C3-1/8-T0-1002-G
A4R28	0698-7227	6	1	RESISTOR 422 1% .05W F TC=0±100	24546	C3-1/8-T0-422R-G
A4R29	0698-6846	3	1	RESISTOR 5.42K .5% .125W F TC=0±50	24546	NC55-1/8-T2-5421-D
A4R30				NOT ASSIGNED		
A4R31	0837-0119	7	1	THERMISTOR ROD 5K-OHM TC=+.7%/C-DEG	28480	0837-0119
A4R32	0698-7259	4	3	RESISTOR 9.09K 1% .05W F TC=0±100	24546	C3-1/8-T0-9091-G
A4R33				NOT ASSIGNED		
A4R35				NOT ASSIGNED		
A4R36	0698-7212	9		RESISTOR 100 1% .05W F TC=0±100	24546	C3-1/8-T0-100R-G

A4 Replaceable Parts (Change E)

Reference Designation	HP Part Number	C D	Qty	Description	Mfr Code	Mfr Part Number
A4R37	0698-7243	6		RESISTOR 1.96K 1% .05W F TC=0±100	24546	C3-1/8-T0-1961-G
A4R38	0698-7212	9		RESISTOR 100 1% .05W F TC=0±100	24546	C3-1/8-T0-100R-G
A4R39	0698-7243	6		RESISTOR 1.96K 1% .05W F TC=0±100	24546	C3-1/8-T0-1961-G
A4R40	0698-7243	6		RESISTOR 1.96K 1% .05W F TC=0±100	24546	C3-1/8-T0-1961-G
A4R41	0698-7283	4	1	RESISTOR 90.9K 1% .05W F TC=0±100	24546	C3-1/8-T0-9092-G
A4R42	0698-7267	4	1	RESISTOR 19.6K 1% .05W F TC=0±100	24546	C3-1/8-T0-1962-G
A4R43	0698-7272	1	1	RESISTOR 31.6K 1% .05W F TC=0±100	24546	C3-1/8-T0-3162-G
A4R44	0698-7275	4	1	RESISTOR 42.2K 1% .05W F TC=0±100	24546	C3-1/8-T0-4222-G
A4R45				NOT ASSIGNED		
A4R46	0698-7207	2	1	RESISTOR 61.9 1% .05W F TC=0±100	24546	C3-1/8-T00-61R9-G
A4R47	2100-2030	6	3	RESISTOR-TRMR 20K 10% C TOP-ADJ 1-TRN	73138	82PR20K
A4R48	0757-0421	4	3	RESISTOR 825 1% .125W F TC=0±100	24546	C4-1/8-T0-825R-F
A4R49	0698-7264	1	1	RESISTOR 14.7K 1% .05W F TC=0±100	24546	C3-1/8-T0-1472-G
A4R50				NOT ASSIGNED		
A4R51*	0698-7282	3	1	RESISTOR 82.5K 1% .05W F TC=0±100	24546	C3-1/8-T0-8252-G
A4R52	0698-7243	6		RESISTOR 1.96K 1% .05W F TC=0±100	24546	C3-1/8-T0-1961-G
A4R53				NOT ASSIGNED		
A4R54	0698-7257	2		RESISTOR 7.5K 1% .05W F TC=0±100	24546	C3-1/8-T0-7501-G
A4R55	0698-7254	9	1	RESISTOR 5.62K 1% .05W F TC=0±100	24546	C3-1/8-T0-5621-G
A4R56	2100-2030	6		RESISTOR-TRMR 20K 10% C TOP-ADJ 1-TRN	73138	82PR20K
A4R57	0757-0280	3	20	RESISTOR 1K 1% .125W F TC=0±100	24546	C4-1/8-T0-1001-F
A4R58	0757-0280	3		RESISTOR 1K 1% .125W F TC=0±100	24546	C4-1/8-T0-1001-F
A4R59	2100-1986	9	1	RESISTOR-TRMR 1K 10% C TOP-ADJ 1-TRN	73138	82PR1K
A4R60	0698-7236	7	1	RESISTOR 1K 1% .05W F TC=0±100	24546	C3-1/8-T0-1001-G
A4R61	0698-7259	4		RESISTOR 9.09K 1% .05W F TC=0±100	24546	C3-1/8-T0-9091-G
A4R62	0698-7270	9		RESISTOR 26.1K 1% .05W F TC=0±100	24546	C3-1/8-T0-2612-G
A4R63	0757-0447	4	3	RESISTOR 16.2K 1% .125W F TC=0±100	24546	C4-1/8-T0-1622-F
A4R64	0757-0280	3		RESISTOR 1K 1% .125W F TC=0±100	24546	C4-1/8-T0-1001-F
A4R65	0698-7260	7		RESISTOR 10K 1% .05W F TC=0±100	24546	C3-1/8-T0-1002-G
A4R66	0757-0401	0		RESISTOR 100 1% .125W F TC=0±100	24546	C4-1/8-T0-100R-F
A4R67	2100-2030	6		RESISTOR-TRMR 20K 10% C TOP-ADJ 1-TRN	73138	82PR20K
A4R68	0698-7236	7		RESISTOR 1K 1% .05W F TC=0±100	24546	C3-1/8-T0-1001-G
A4R69	0698-3440	7		RESISTOR 196 1% .125W F TC=0±100	24546	C4-1/8-T0-196R-F
A4R70				NOT ASSIGNED		
A4R71	0698-3452	1	2	RESISTOR 147K 1% .125W F TC=0±100	24546	C4-1/8-T0-1473-F
A4R72	0757-0279	0	1	RESISTOR 3.16K 1% .125W F TC=0±100	24546	C4-1/8-T0-3161-F
A4R73	0698-7277	6	1	RESISTOR 51.1K 1% .05W F TC=0±100	24546	C3-1/8-T0-5112-G
A4R74	0698-7251	6	1	RESISTOR 4.22K 1% .05W F TC=0±100	24546	C3-1/8-T0-4221-G
A4R75-				NOT ASSIGNED		
A4R90				JUMPER		
A4R91	8159-0005	0		NOT ASSIGNED		
A4R92				NOT ASSIGNED		
A4R93	0698-7212	9		RESISTOR 100 1% .05W F TC=0±100	24546	C3-1/8-T0-100R-G
A4R94	0698-7253	8		RESISTOR 5.11K 1% .05W F TC=0±100	24546	C3-1/8-T0-5111-G
A4R95	0698-7222	1	1	RESISTOR 261 1% .05W F TC=0±100	24546	C3-1/8-T0-261R-G
A4R96				NOT ASSIGNED		
A4R97				NOT ASSIGNED		
A4R98	0698-7236	7		RESISTOR 1K 1% .05W F TC=0±100	24546	C3-1/8-T0-1001-G

A4 Replaceable Parts (Change E)

Reference Designation	HP Part Number	C D	Qty	Description	Mfr Code	Mfr Part Number
A4TP1	1251-4672	4	9	CONNECTOR 10-PIN M POST TYPE	22526	65500-110
A4TP7						
A4TP8-	1251-5041	3		CONNECTOR 5-PIN M POST TYPE	22526	65500-105
A4TP10	0360-0535	0	21	TERMINAL TEST POINT PCB	00000	ORDER BY DESCRIPTION
A4TP11						
A4TP12	0360-0535	0		TERMINAL TEST POINT PCB	00000	ORDER BY DESCRIPTION
A4TP13				NOT ASSIGNED		
A4TP14	0360-0535	0		TERMINAL TEST POINT PCB	00000	ORDER BY DESCRIPTION
A4TP15	0360-0535	0		TERMINAL TEST POINT PCB	00000	ORDER BY DESCRIPTION
A4U1	1826-0261	8	4	IC OP AMP LOW-NOISE TO-99 PKG	28480	1826-0261
A4U2	1826-0417	6	2	IC SWITCH ANLG QUAD 16-DIP-C PKG	27014	LF13333D
A4U3	1826-0616	7	1	IC OP AMP PRON QUAD 14-DIP-C PKG	06665	OP-11EY
A4U4	1826-0590	6	2	IC MULTIPLXR 4-CHAN-ANLG DUAL 16-DIP-C	27014	LF13509D
A4U5	1826-0319	7	3	IC OP AMP LOW-BIAS-H-IMPD TO-99 PKG	04713	LF356G
A4U6	1826-0590	6		IC MULTIPLXR 4-CHAN-ANLG DUAL 16-DIP-C	27014	LF13509D
A4U7	1826-0447	2		IC OP AMP LOW-BIAS-H-IMPD TO-99 PKG	04713	LF356G
A4U8	1826-0021	8	1	IC OP AMP GP TO-99 PKG	27014	LM310H
A4U9	1826-0417	6		IC SWITCH ANLG QUAD 16-DIP-C PKG	27014	LF13333D
A4U10	1820-1197	9		IC GATE TTL LS NAND QUAD 2-INP	01295	SN74LS00N
A4U11	1826-0319	7		IC OP AMP LOW-BIAS-H-IMPD TO-99 PKG	04713	LF356G
A4U12	1820-1216	3		IC DCDR TTL LS 3-TO-8-LINE 3-INP	01295	SN74LS138N
A4U13	1820-1730	6		IC FF TTL LS D-TYPE POS-EDGE- RIG COM	01295	SN74LS273N
A4U14	1826-0752	2	1	IC CONV 12-B-D/A 16-DIP-C PKG	24355	AD7542BD
A4U15	1826-0026	3	2	IC COMPARATOR PRON TO-99 PKG	01295	LM311L
A4VR1	1902-0049	2	2	DIODE-ZNR 6.19V 5% DO-35 PD=.4W	28480	1902-0049
A4VR2	1902-0049	2		DIODE-ZNR 6.19V 5% DO-35 PD=.4W	28480	1902-0049
A4VR3	1902-0041	4		DIODE-ZNR 5.11V 5% DO-35 PD=.4W	28480	1902-0041
A4VR4	1902-3139	7	1	DIODE-ZNR 8.25V 5% DO-35 PD=.4W TC=+.05%	28480	1902-3139
A4VR5				NOT ASSIGNED		

A4 ALC Troubleshooting

INTRODUCTION

Since the Automatic Level Control (ALC) function of the 83570A RF Plug-In includes many individual components arranged in a highly interdependent closed loop, the scope of the A4 ALC troubleshooting section extends well beyond the limits of the A4 assembly. Portions of the A5 FM Driver assembly, and several microcircuit components which contribute to the power leveling function, are discussed below.

The ALC "loop" is a complex feedback loop which monitors the RF output power and continuously corrects for any deviation from the desired power level. Because it is a closed system, it is difficult to isolate cause from effect when a problem arises. The key to troubleshooting is to examine individual components, correlating the expected output for a particular input signal.

This troubleshooting outline is organized into two major sections: Troubleshooting Symptoms and Troubleshooting Diagnostics. The section entitled **Troubleshooting Symptoms** (1) characterizes possible failure modes, (2) provides some general troubleshooting hints, and (3) refers the reader to more detailed procedures found under **Troubleshooting Diagnostics**.

TROUBLESHOOTING SYMPTOMS

The procedures outlined below help to systematically characterize the failure as quickly as possible. The following failure symptoms are discussed:

- RPG/Power Display Failure**
- UNLEVELED (LED)**
- Flatness/Oscillations (Power Drop-outs)**
- Full Unleveled Power**
- No Power**
- Power Sweep/Flatness**

Evaluating the failure mode may require an HP 432A Power Meter or the HP 8755C Swept Amplitude Analyzer with the 11664B Detector with an adapter. (However, a crystal detector with an "A vs B" oscilloscope may often be substituted.) Figure 7E-1 shows a typical test setup. Initiate all tests with the INSTR PRESET condition.

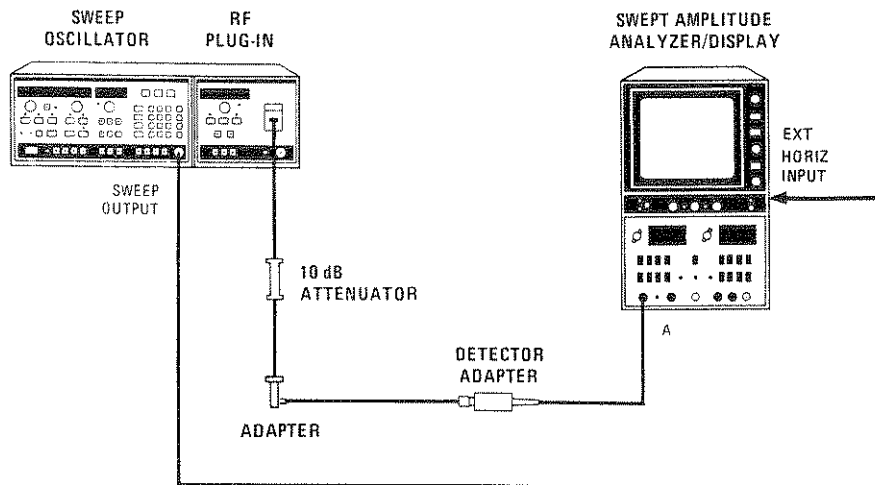

Figure 7E-1. Typical ALC Troubleshooting Setup

RPG/POWER DISPLAY FAILURE

Check that the POWER display changes when either the RPG is rotated or data is entered via the HP 8350 keyboard. This verifies that the digital information is reaching the mainframe, is properly processed, and then displayed.

- If the display is flashing rapidly or showing random patterns, refer to A1 Front Panel or A3 Digital Interface troubleshooting. If the RPG causes a change in the measured RF power level, but the POWER display remains the same, refer to A1 troubleshooting. If the RPG produces no response whatsoever, or if the front panel display is blank, refer to A1 troubleshooting, and trace the problem back to the HP 8350 mainframe.

UNLEVELED (LED)

Comparator A4U15 enables the front panel UNLEVELED LED when the voltage at its noninverting input drops below approximately -0.6 Vdc, indicating that the RF output power is insufficient to level to the desired power reference.

- Before inspecting loop components, determine whether the UNLEVELED light is on during forward sweep or retrace. Enter a sweep time of 5 seconds. If the UNLEVELED light is on coincident with retrace (SWEEP light off), then the problem is probably in the "UNLEVELED" LED annunciator drivers. Refer to A7 Service Sheet for troubleshooting information.
- If the UNLEVELED LED is on for the entire forward sweep, check the RF output power with a power meter. If minimal RF output power is recorded, refer to the section entitled **NO POWER**.
- If the UNLEVELED light flashes briefly during the sweep, but does not imply any of the above failure modes, check power flatness. See below.

FLATNESS/OSCILLATIONS (POWER DROP-OUTS)

Monitor the RF output with the HP 8755C as shown in Figure 7E-1.

- If the power level across the sweep is within approximately 5 dB, then the Plug-In may only require ALC flatness adjustments. Refer to Section V, Adjustments, in this manual, for the Internal Levelled Flatness adjustment procedure.
- If the measured power level is between $+10$ and -1 dBm, but cannot be controlled from the front panel, refer to the Digital Control section under Troubleshooting Diagnosis.
- If the trace appears chopped or broken the loop may be oscillating. Refer to Section V, Adjustments, in this manual, and perform the ALC Gain adjustment procedure.

FULL UNLEVELED POWER

If power is unlevelled, continue to sweep the Plug-In's full range.

- Attempt to level the power externally using the HP 432 Power Meter as shown in Figure 7E-2. Select MTR leveling, and enter a slow (at least 50 seconds) sweep time. If the RF power is now leveled, then the failure is most likely in the detector or the Detector Selection Switch A4U6 (refer to the following paragraph). If this does not prove to be the case, the problem may be in the two analog switches U4B and U6A; or it may be necessary to perform the ALC adjustments in Section V of this manual.

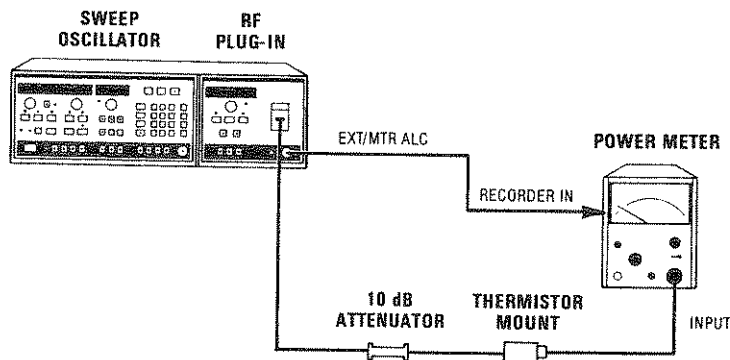

Figure 7E-2. Power Meter Leveling Setup

- Check the Detector Selection Switch by entering a CW frequency within the leveling mode in question and trace the detector voltage through U6B. If the input to be selected does not match the output, check the MUX A0 and MUX A1 lines (see Table 8-9). Also check U12 and U13 as described under Digital Control.
- Check the voltage at TP6. If it is at +8.5 Vdc, suspect the Modulator Driver on the A2A1 assembly, or the Modulator diodes in A2A2. If it is below +0.5 Vdc, suspect the Detector and Detector Leg.

NOTE: Turn off line switch before removing or installing any assembly.

NO POWER

- To check the RF components, remove the A4 ALC assembly from its socket. This removes bias from the modulator, and should allow maximum power through the RF path. If full power (over +12 dBm) is then detected, the A2 Doubler and A9 YO are verified. Suspect primarily the detector, inside A2A2. Also inspect the modulator (part of A2), as well as the modulator Driver on A2A1, and the A4 Detector Selection Switch.
- If the detector appears to be functioning properly, reinstall the A4 board and check A4TP6. If less than +0.5 Vdc is found, check continuity from A4TP6 to the modulator Driver circuit, A2A1J3 pin 11. If A4TP6 is at +8.5 Vdc, suspect any circuitry between the Detector Selection Switch and A4TP6, particularly the Log Amp.
- Refer to Figure 7E-3 and check the L RFB line, A4P1-29. If it is stuck low, the loop will shut down the RF.
- If the failure has not been located, suspect components of the RF path. Refer to RF Troubleshooting for details.

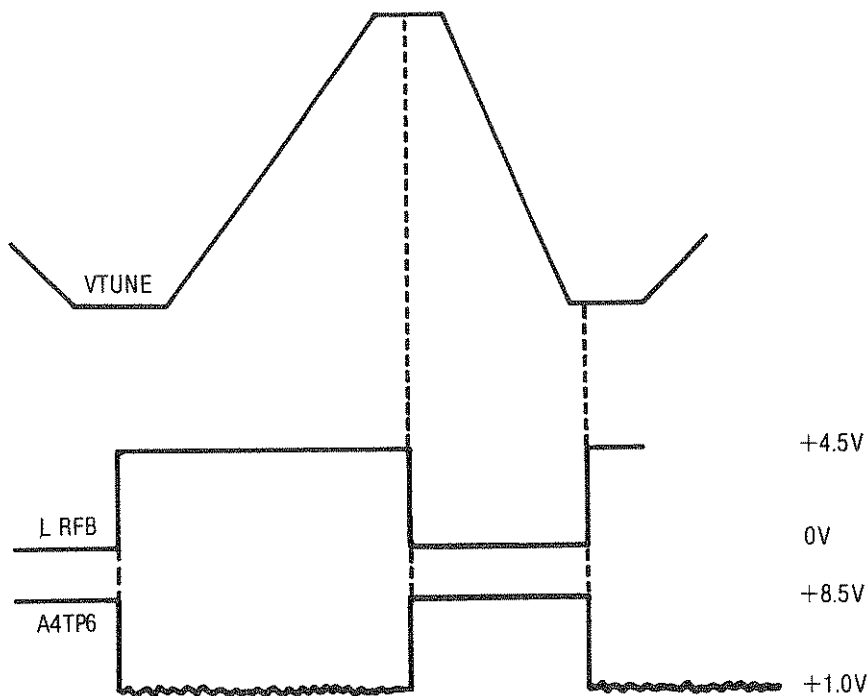

Press HP 8350A/B [RF BLANK].

Figure 7E-3. RF Blanking

POWER SWEEP/FLATNESS

If power increases smoothly with frequency, and POWER SWEEP is NOT selected, suspect problems with the A5 FM Driver assembly.

- Check A5TP8 with an oscilloscope. If the indication is NOT zero volts, refer to the A5 service sheet and perform the DAC test.
- If the RF power is leveled within approximately 5 dB, refer to Section V, Adjustments, in this manual, and perform the Internal Leveled Flatness adjustment procedure.

TROUBLESHOOTING DIAGNOSTICS

The troubleshooting information below is organized into functional areas:

DIGITAL CONTROL, BLOCK A
 POWER LEVEL REFERENCE, BLOCKS C AND F
 INTERNAL DETECTOR/DETECTOR SELECTION SWITCH, BLOCK B
 DETECTOR LEG, BLOCKS D AND E
 MODULATOR LEG, BLOCKS G AND I
 MOD DRIVER A2A1
 MODULATOR A2

DIGITAL CONTROL, BLOCK A

Address Decoder U12 and Control Latch U13 control digital switches throughout the A4 assembly. Their operation can be confirmed by performing the Hex Data Rotation Write at address 2C07 Hex. Enter the following key strokes:

[SHIFT] [0] [0] [2] [GHz s] [0] [7] [M4]	Enters Hex Data Command Address location 2C07 (U13) Hex Data Rotation Write
--	---

Check the outputs of U13 for the waveforms shown in Figure 8-2.

- If any output signal is missing or displaced, check the data lines against Figure 8-2. If no output is found, look for activity at U13 pin 11. Check for L INST1 and BA3 to pulse low, while BA0, BA1, and BA2 pulse high. If these pulses are missing, trace the problem back to A3 Digital Interface.

If the Digital Control section is working, the primary outputs of U13 are easily controlled by selecting the appropriate front panel function while in the CW sweep mode. (e.g., selecting MTR leveling holds the PM line high, etc.).

POWER LEVEL REFERENCE, BLOCKS C and F

The Reference Power Level Leg produces a voltage proportional to the "desired" power level. This signal is a summation of the absolute power reference, ALC compensation, AM, and power sweep signals.

The ALC compensation and power sweep signals are generated on the A5 FM Driver assembly. If an A5 failure is suspected, refer to troubleshooting information on the A5 Service Sheet. Unless A5 is suspect, simplify the troubleshooting for the Reference Power Level circuit by selecting either EXT or MTR ALC mode. This will eliminate the compensation signals from the A5 assembly and the FREQ TRK V from A7.

DAC U14 establishes the absolute power level. The $-10V$ REF from the A6 assembly is scaled to yield from 0 Vdc (-1 dBm displayed) to $+8.4$ Vdc ($+19$ dBm displayed) at TP2. (This breaks down to a voltage step of 0.42 Vdc per 1.0 dB of power over the dynamic range, or about $+4.62$ Vdc at $+10$ dBm.)

A self-test routine is available to exercise the ALC DAC. Enter:

[SHIFT] [5] [0]

The waveform in Figure 7E-4 should be seen at TP2. Note that the exercise routine for the 12-bit DAC yields a staircased waveform with 13 levels. The first step shows the maximum $+10$ Vdc output with all bits high. The following levels represent the voltage at TP2 with successive bits loaded high in order from the Most Significant Bit to the Least Significant Bit.

- If the waveform at TP2 is not correct, check for $-10V$ REF, and trace any problem back to the A6 assembly. Look for activity on L INST1, BA0, and BA1 lines. BA2 and BA3 should pulse high as each new DAC value is loaded, pulsing the CS line (U14 pin 8) low. If any of these lines, or a data line, appears dead, trace the problem back to the A3 assembly.

U3A adds PWR SWP/COMP and AM, and provides detector flatness compensation at higher power levels with CR3. Use the EXT MTR mode to bypass this diode while troubleshooting.

U3C adds the front panel amplitude adjustment (EXT CAL) used with external leveling. It also adds a scaled tuning voltage (FREQ TRK V) proportional to frequency. This ramp works with the PWR SW/COMP signal from the A5 assembly to accomplish the flatness compensation adjustments. With the A5 board removed, an offset ramp will be seen at TP2. An amplitude modulation (AM) signal of 1.0 V_{p-p} at P1-4 will produce roughly 260 mV p-p at TP1. (Note that U4A and CR3 in the feedback path around U3A change the gain depending on the desired power level.)

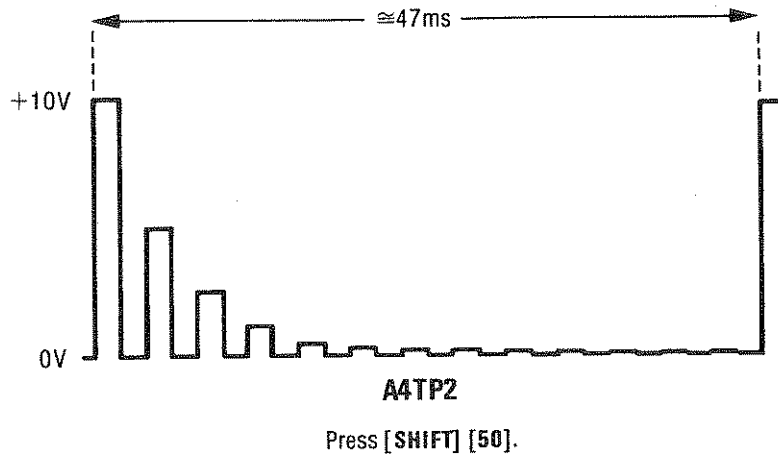

Figure 7E-4. DAC Test

DETECTOR/DETECTOR SELECTION SWITCH, BLOCK B

The detector (internal to the A2A2 microcircuit) is tested simply by checking the output voltage under full leveled power or full unleveled power conditions.

- If no RF output power is measured, turn off the line power and remove the A4 assembly. Return power to the instrument. (If there is still no RF power, suspect components of the RF path. Refer to RF Troubleshooting.) If full unleveled RF power is obtained, check the detector voltage against those listed in Table 7E-1.
- If full leveled power (+10 dBm) or full unleveled power (at least +12 dBm) is measured, check the voltages at the detector input against the values shown in Table 7E-1. (Use high-impedance 10:1 probes.)

Table 7E-1. Detector Voltages

A4P1-20	Full Leveled +9 dBm	Full Unleveled +12 dBm
		-60 to -100 mV

- If the detector is working and the Detector Selection Switch is suspected, monitor TP15 for the voltage seen at the selected input of U6B.
- If the EXT/MTR ALC INPUT circuits are suspected, select the desired mode and supply a test signal (low-level DC or sine wave) in the front panel BNC connector, and trace it through U6B at A4TP15.

DETECTOR LEG, BLOCKS D and E

The "Detector Leg" of the ALC loop includes components between the Detector Selection Switch and the Error Summing Amplifier U3D.

Before troubleshooting the Detector Leg, be sure the Detector and Detector Selection Switch are working correctly. See above.

The Detector Leg can be effectively tested by using the Open Loop method of troubleshooting. This procedure utilizes the external leveling mode [EXT] by supplying an external DC voltage or sine wave to the EXT/MTR ALC INPUT connector. This method breaks the ALC loop and allows waveforms to be checked against known test signals. See Figure 7E-5.

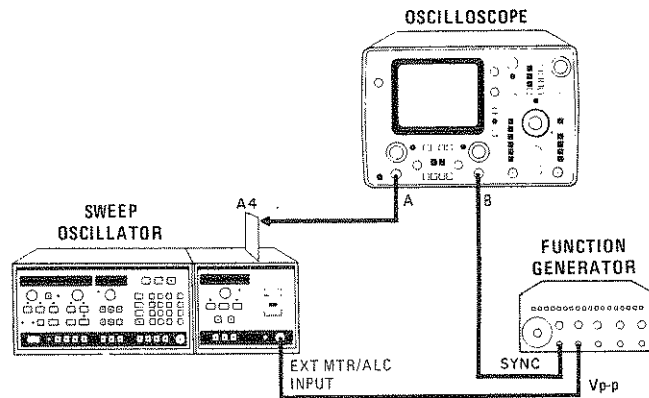

EQUIPMENT

Function Generator	HP 3312A
Oscilloscope	HP 1740A

PROCEDURE

1. Press HP 8350 [INSTR PRESET].
2. Press HP 83570A [EXT] ALC.
3. Adjust Function Generator output for a 50 mV p-p sine wave at 500 Hz. Adjust the OFFSET knob for -25 mVdc.
4. Connect Function Generator output to EXT/MTR ALC connector.
5. Set oscilloscope DISPLAY to A and TRIGGER COMP to B. Check for the waveforms shown in Figure 7E-6.

NOTE: The HP 3312 OFFSET knob may have to be adjusted slightly to produce the waveforms given in Figure 7E-6. If the EXT/MTR ALC input goes positive, the Log Amp will saturate.

Adjustment of the EXT/MTR ALC CAL knob will affect the waveforms at A4TP4, TP7, and TP6. Adjust the CAL knob until these waveforms are obtained.

Slight differences may be noted between the waveforms shown in Figure 7E-6 and those obtained on individual ALC assemblies. This is due to the many adjustments on the A4 assembly.

Figure 7E-5. Open Loop Procedure

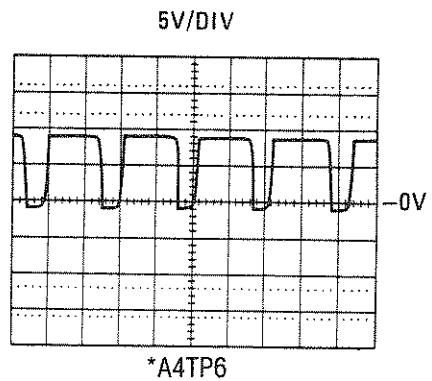
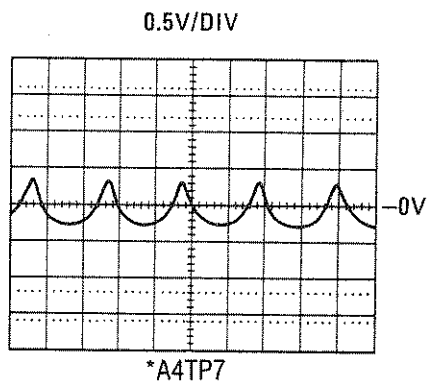
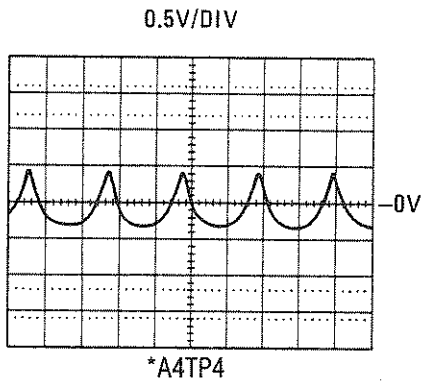
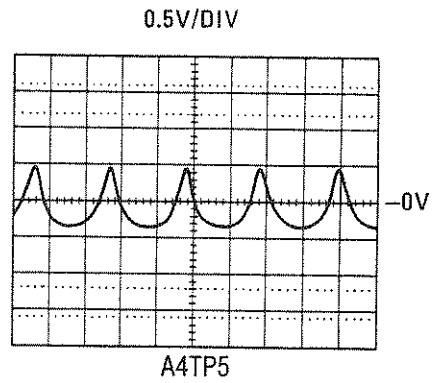
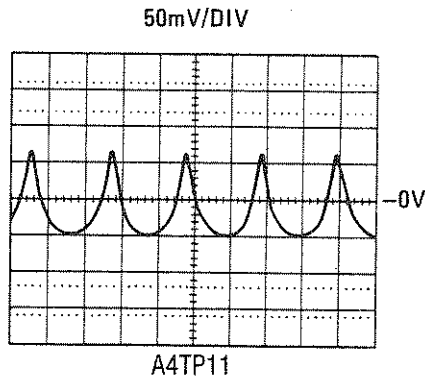
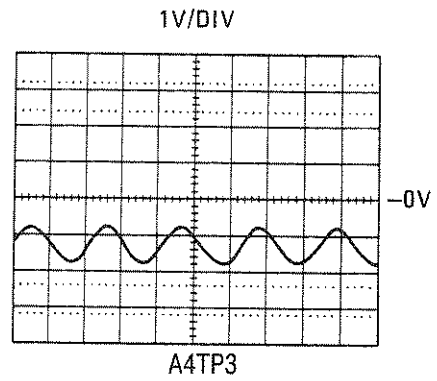
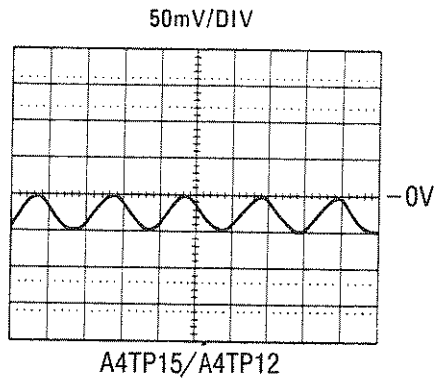

Horizontal scale = 1 ms/DIV

*Power = +9 dBm
Offset depends on Power Level
and EXT/MTR ALC CAL.

Figure 7E-6. Open Loop Waveforms

MODULATOR LEG

The "Modulator Leg" includes the Error Sample & Hold and the Main ALC Amp.

U3D is a non-inverting unity-gain summing amplifier. Under leveled conditions, both TP4 and TP7 should be nearly 0.0 Vdc. Under any conditions, TP4 and TP7 should be at the same voltage. If not, suspect U3D, Q3, or the Sample & Hold Driver.

U11 forms an inverting integrator. When TP7 is positive, TP6 should be at -1.2 Vdc. If not, suspect U2D or U11. When TP7 is negative, TP6 should be at $+8.5$ Vdc. If this is not the case, suspect U11.

- The following procedure can be used to check U3D and U11:

1. Set power for -1 dBm at any CW frequency.
2. Press HP 83570A [EXT] ALC.
3. Ground A4TP11.
4. To check U3D, monitor TP4 and TP7 while adjusting the EXT/MTR ALC CAL knob between the extremes of its range. Both TP4 and TP7 should vary between approximately $+0.5$ and -0.5 Vdc.
5. Verify U11 by adjusting the CAL knob as described above and monitoring TP6. Since U11 is an integrator, TP6 should saturate and clamp (due to VR4, CR10, and CR11) at -1.2 Vdc and $+8.5$ Vdc, respectively.

Further troubleshooting of the Modulator Leg can be continued by following the Open Loop Procedure outlined in Figure 7E-5 and checking for the waveforms provided in Figure 7E-6.

MODULATOR DRIVER (Part of A2A1) and RF MODULATOR (Part of A2A2)

NOTE: The Mod Driver circuit is located on the A2A1 assembly, attached directly to the A2A2 Doubler microcircuit. The internal RF Modulator is inside the A2A2 Doubler microcircuit package and cannot be separately replaced. Refer to the RF Schematic and A2 Service Sheet for schematics, component locations, and additional troubleshooting information.



The A2A2 Doubler assembly is susceptible to damage from electrostatic discharge. This is especially true when the A2A2 microcircuit is removed from the A2A1 Bias board. Take the necessary precautions to avoid static discharge to this assembly.

The RF modulator in this Plug-In is a negative-bias shunt-type diode. Figure 7E-7 provides a simplified schematic for this modulator. The Mod Driver provides the voltage-to-current conversion and current gain needed to drive the modulator. As the MOD DRIVE voltage at A4TP6 increases, the current drawn from the Modulator by A2A1Q3 also increases, shunting more RF energy to ground and allowing less to pass through.

To establish a fixed voltage level for troubleshooting, A4TP6 can be forced high (+8.5 Vdc) or low (−1.2 Vdc). Ground TP11 on the A4 assembly. Select HP 83570A [EXT] ALC, and enter an RF power level of −1 dBm with the front panel controls. Rotate the EXT/MTR ALC CAL knob fully clockwise, and verify a signal level of approximately +8.5 Vdc at A4TP6 and −0.9 Vdc at A2A1TP5. (The front panel UNLEVELED LED should NOT light.) Turn the CAL control fully counter-clockwise and check for −1.2 Vdc at A4TP6 and +9.5 Vdc at A2A1TP5. (In this case, the UNLEVELED lamp should light.)

During normal operation, A4TP6 should be approximately +0.7 Vdc, while A2A1TP5 should be close to −0.6 Vdc.

Table 7E-2 provides the approximate bias levels for a properly functioning modulator assembly.

Table 7E-2. Modulator Bias Levels

TP4	A2A1TP5
+8.5V	−0.9V (Minimum RF)
+0.7V	−0.6V (Leveled Operation)
−1.2V	+9.5V (Maximum RF)

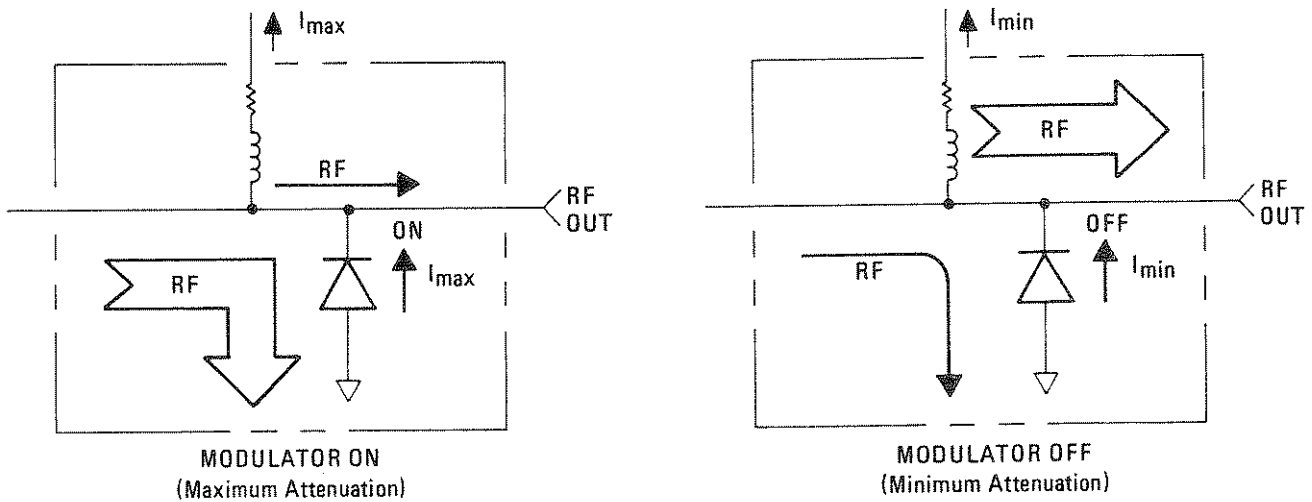

Figure 7E-7. Simplified Modulator Schematic

NO RF POWER

NOTE: Turn off line power before removing or installing any assembly.

If the symptom is no RF power, remove the A4 ALC assembly. This will remove bias from the driver, turn A2A1Q3 off, and hence allow full RF power to pass through the modulator. If full unlevelled RF power is obtained, suspect the RF detector or A4 assembly. Check the A4TP6 voltages listed in Table 7E-2 and the detector output voltage listed in Table 7E-1.

If there is still no RF power with A4 removed, reinstall the A4 assembly. Force A4TP6 alternately high and low as described above, and check the voltage at A2A1TP5 against the values given in Table 7E-2.

- If A2A1TP5 stays near 0 Vdc, the modulator diode is probably shorted. However, before replacing any microcircuit, always check the power level directly into and out of the assembly to ensure that the problem is isolated to that particular assembly.
- Force A4TP6 low (−1.2 Vdc) as described above. This should turn A2A1Q3 off, allowing both A2A1TP5 and the collector of A2A1Q3 to float to approximately +9.5 Vdc. If A2A1TP5 stays near 0 Vdc, the modulator is probably shorted.

If A2A1Q3 and the modulator are functioning properly, but RF power is still missing or low, check the following RF levels with a power meter or spectrum analyzer. When checking power levels internal to the RF signal path, ensure that all critical ports are terminated in 50 ohms.

- If power is minimal, check the RF level directly out of A9 YO. The minimum level from this assembly should measure +13 dBm.
- Check the RF levels around A2 Doubler with no modulation (i.e. remove the A4 assembly). Unlevelled power from A2A2 should reach approximately +11 dBm. If the problem appears to be the A2A2 Doubler microcircuit or the A2A1 Pulse Assembly, refer to the A2 Service Sheet for further troubleshooting information.

FULL UNLEVELED RF POWER

If maximum unleveled RF power is observed, attempt to achieve maximum attenuation (minimum RF transmitted) by forcing A4TP6 high (+8.5 Vdc) as described above. A2A1TP5 should read approximately -0.9 Vdc.

- If the voltage at A2A1TP5 is approximately -9.0 Vdc, the modulator diode is probably open. However, be sure to check for open contacts between the A2A1 Pulse Board and A2A2 Doubler microcircuit package before replacing the assembly.
- If A2A1TP5 reads 0 Vdc, the modulator diode is probably shorted.
- If A2A1TP5 reads approximately $+9.5$ Vdc, A2A1Q3 is probably open.

A4 Automatic Leveling Control (ALC) Circuit Description (Change E)

INTRODUCTION

The A4 Automatic Level Control (ALC) assembly is part of a closed loop power leveling function, designed to control the amplitude of the RF output power. The General section below describes loop operation, including some components external to the A4 assembly. The rest of this operational theory is devoted to detailed description of the circuits found on the A4 assembly.

GENERAL

The circuits which accomplish power control and power leveling can be divided into two categories: internal loop circuitry, and external components of the loop. This is illustrated in Figure 7E-8.

The Power Level Reference leg of the ALC circuit establishes the desired power level. This is accomplished by pressing the Plug-In POWER LEVEL pushbutton and rotating the RPG or entering the desired reference on the HP 8350 front panel DATA ENTRY keys. This leg of the ALC is independent of the loop as shown in Figure 7E-8.

The Detector leg of the ALC loop samples the actual RF output power and produces a voltage proportional to RF amplitude. This voltage is converted to log scale and compared with the Power Level Reference signal. If the voltages at the summing junction (TP4) are not of equal magnitude an error voltage is generated. This error voltage is amplified and converted to a current drive for the RF modulators which vary the transmitted RF power to correct the error and achieve the desired RF power level.

ADDRESS DECODER AND CONTROL LATCHES, BLOCK A

U12 is a 3-to-8 decoder, selecting address 2C07H when it is present on the address bus. This address serves as a chip enable for octal latch U13. Information on the data bus is then latched into U13 and used throughout the A4 assembly.

DETECTOR INPUTS AND SELECTION SWITCHES, BLOCK B

Control lines MUX A0 and MUX A1 are encoded with leveling mode selection information. U6 decodes these control lines to select the proper detector input for the desired operating mode. Table 7E-8 provides a truth table for these lines.

EXT/MTR ALC input provides external crystal leveling capability within the -10 to -200 mV range. VR1 and VR2 provide protection against transients. Two Schottky diodes, CR2 and CR3, are mounted between the EXT/MTR ALC connector and the front panel casting for similar protection.

When MTR (power meter) leveling is selected, U1 inverts the positive RECORDER output (approximately 0 to +1 Vdc full scale) of the HP 432A. R41 and C9 compensate for power meter response. Additional compensation occurs in the Main ALC Amp.

SAMPLE AND HOLD DRIVER, BLOCK H

U10A outputs a high pulse when L PULSE goes low. U10D gates this high level with PULSE EN, and drives Q15 on and off. Q2B switches between saturation and cutoff, controlling both of the sampling FETs, Q1 and Q3. The Sample and Hold function of the ALC loop is used in conjunction with pulse modulation. When PULSE ENABLE is high, and L PULSE is low, Q2B will saturate, initiating the Hold mode.

The frequency of the sampling mode is dependent on the L PULSE input. When the system is used with the HP 8755 Swept Amplitude Analyzer, the L PULSE input will be a 27.8 kHz square wave, controlling the gates of Q1 and Q3. L PULSE also appears at the input of the Pulse Amplifier on the A2A1 assembly, to initiate the actual modulation. Propagation delays are such that the HOLD mode (of the ALC loop) is achieved just prior to RF modulation. This ensures that sampling occurs only during the ON pulse. The sample level is maintained during the OFF pulse, thus preventing saturation of the Log and Main ALC amplifiers.

INPUT SAMPLE AND HOLD, BLOCK D

The Input Sample and Hold function prevents the Log Amplifier from saturating during pulse modulation.

U8 is a unity gain follower with internal feedback which buffers the detector input. R59 compensates for the offset voltage of op amp U8. Q1 and C11 perform the sample and hold function.

LOG AMPLIFIER, BLOCK E

The logarithmic scaling function is performed by Q6A in the feedback loop of U7. Q6A collector current is proportional to the voltage at TP12 and exponentially related to its base-emitter voltage. Therefore, Q6A emitter voltage is logarithmically related to the input voltage at TP12.

Q6B compensates the Log Amp against changes in reverse saturation current with temperature.

CR4 provides a positive current path preventing U7 from saturating when the input is greater than or equal to 0 volts.

U6 decodes MUX A0 and MUX A1 (Table 7E-3) to select the proper offset voltage for power calibration at the low end of the Plug-In power range. In EXTERNAL ALC, the minimum leveled power is set with the front panel EXT CAL potentiometer.

U5 amplifies the logged output for comparison with the Power Level Summing signal. R8 adjusts the gain of U5, and calibrates midrange power levels. R9 is selected during power meter leveling to adjust the gain of the log amp for compatibility with the HP 432A Power Meter.

Guarded-gate FETs Q7 and Q8 select the appropriate detector return for INTERNAL and EXTERNAL leveling.

POWER LEVEL REFERENCE, BLOCK C

POWER LEVEL SUMMING, BLOCK F

U14 is a 12-bit microprocessor-compatible D/A converter, which latches data in three 4-bit nibbles. The -10V REF input sets the DAC for a maximum output at TP2 of $+10\text{V}$. The voltage at TP2 is the product of -10V VREF and the fractional binary input of the DAC.

The voltage at TP1 is the sum of several voltages, depending on the operating mode of the Plug-In. U3A sums PWR SWP/COMP from the A5 assembly and the AM input from the 8350A rear panel. In addition, R3, in the feedback loop of U3A, reduces gain to compensate for detector deviation from square-law at the upper limits of the Plug-In power range. U3C sums the EXT CAL input, which provides front panel offset control for external leveling, and FREQ TRK V, a 0 to $+6\text{V}$ ramp.

R31, in the feedback loop of U3C, provides temperature compensation for the Log Amplifier and Detector.

ERROR, SAMPLE AND HOLD, BLOCK G

TP4 is the summing junction for the Power Level Summing and Log Amplifier outputs. Under leveled power conditions, the voltage at TP4 is zero. A non-zero voltage represents an error and forces a change in modulator current until power is again level.

U3D buffers the error voltage. Q3 provides sample and hold capability during pulse modulation. R69 reduces the coupling effect of parasitic capacitance in Q3.

C18 provides the proper sample and hold switching delay.

MAIN ALC AMP, BLOCK I

UNLEVEL SIGNAL, BLOCK J

Both inputs to integrator U11 are at virtual ground under level power conditions, allowing for immediate response to an input error voltage.

R11 optimizes the speed at which the loop responds to power level changes.

When HP 8350 RF BLANK is selected, L RFB goes low and blanks the RF power during retrace; U2D closes, pulling current through C22, forcing TP6 high and turning on the modulator.

C21 compensates for the response time of the ALC loop during power meter leveling to prevent oscillations.

CR10 and CR11 reduce the capacitive loading of the integrator introduced by VR4.

Under unlevelled conditions, VR4, CR10, and CR11 will clamp the output of U11, MOD DRIVE, at approximately -1.2 and $+8.5$ volts, preventing negative or positive saturation. Under leveled power conditions, MOD DRIVE should measure approximately $+0.5$ to $+1.5\text{V}$. When the output of U11 dips below -0.6 volts, comparator U15 activates the front panel LED indicating unlevelled power.

The MOD DRIVE voltage is converted to a current source to drive the modulator in the microcircuit package. This voltage-to-current converter is found on the A2A1 assembly, attached directly to the microcircuit. For more information on this circuit, refer to the A2 Service Sheet.

Table 7E-3. ALC Control Lines

DATA BUS		Leveling Mode
Mux A1	Mux A0	
H	H	Not Used
H	L	INT DET
L	H	EXT DET
L	L	Power Meter

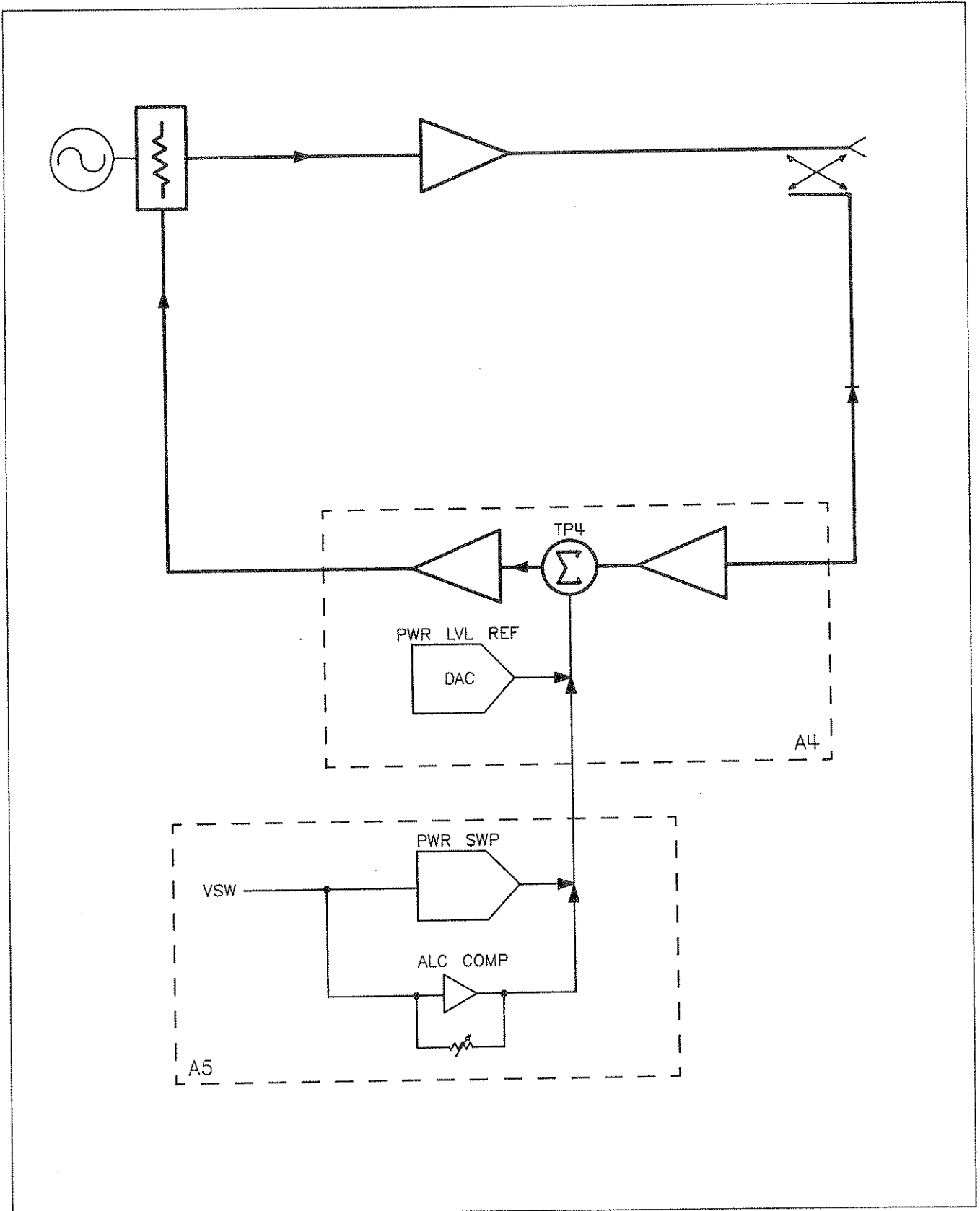
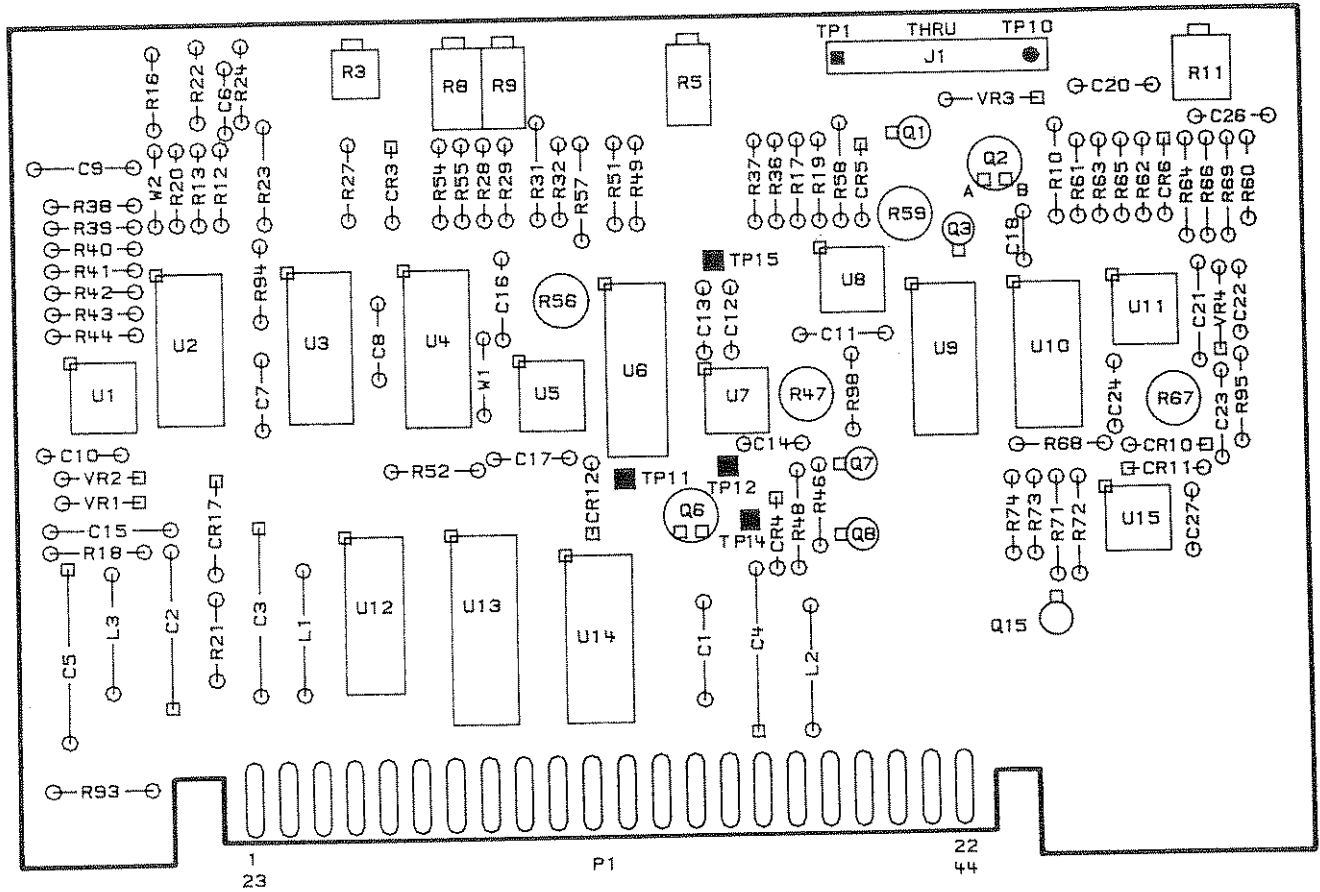

Figure 7E-8. Simplified ALC Block Diagram

Connector Pin Descriptions

A4P1

PIN	SIGNAL	I/O	TO/FROM	BLOCK
1 23	EXT DET RET EXT DET	IN IN	A8J2 A8J2	P B
2 24	LUNLVL EXT CAL	OUT IN	A6P1-40, A7P1-29 A8J1-12	M H
3 25	PWR REF FREQ TRK V	IN	Not Used A7P1-41	C F
4 26	AM	IN	P1-A4 Not Used	C
5 27	PWRSW/COMP +5V	IN IN	A5P1-23 A3P1-6, 7	C P
6 28	-40V -15V	IN IN	P1-11 P2-28	P P
7 29	+10V LRFB	IN IN	P1-8 P2-56	P L
8 30	GND DIG GND DIG			P P
9 31	BD1 BD0	IN IN	A3P1-9 A3P1-31	A,C A,C
10 32	BD3 BD2	IN IN	A3P1-10 A3P1-32	A,C A,C
11 33	BA1 BA0	IN IN	A3P1-11 A3P1-33	A,C A,C
12 34	BA3 BA2	IN IN	A3P1-12 A3P1-34	A,C A,C
13 35	BD5 BD4	IN IN	A3P1-13 A3P1-35	A A
14 36	BD7 BD6	IN IN	A3P1-14 A3P1-36	A A
15 37	GND ANLG GND ANLG			P P
16 38	+20V +15V	IN	Not Used P2-29	P
17 39	-10V -40V	IN IN	P1-13 P1-11	P P
18 40	LINST1	IN	A3P1-8 Not Used	A,C
19 41	LPULSE	IN	Not Used A7P1-23	K
20 42	INT DET1 INT DET RET	IN IN	A2A1J3-2 A2A1J3-9	B P
21 43	-10V REF	IN	Not Used A6P1-5	C
22 44	MOD DRIVE	OUT	A2A1J3-11 Not Used	L



HP P/N 83570-60067

Figure 8-31. A4 ALC Component Locations

A4

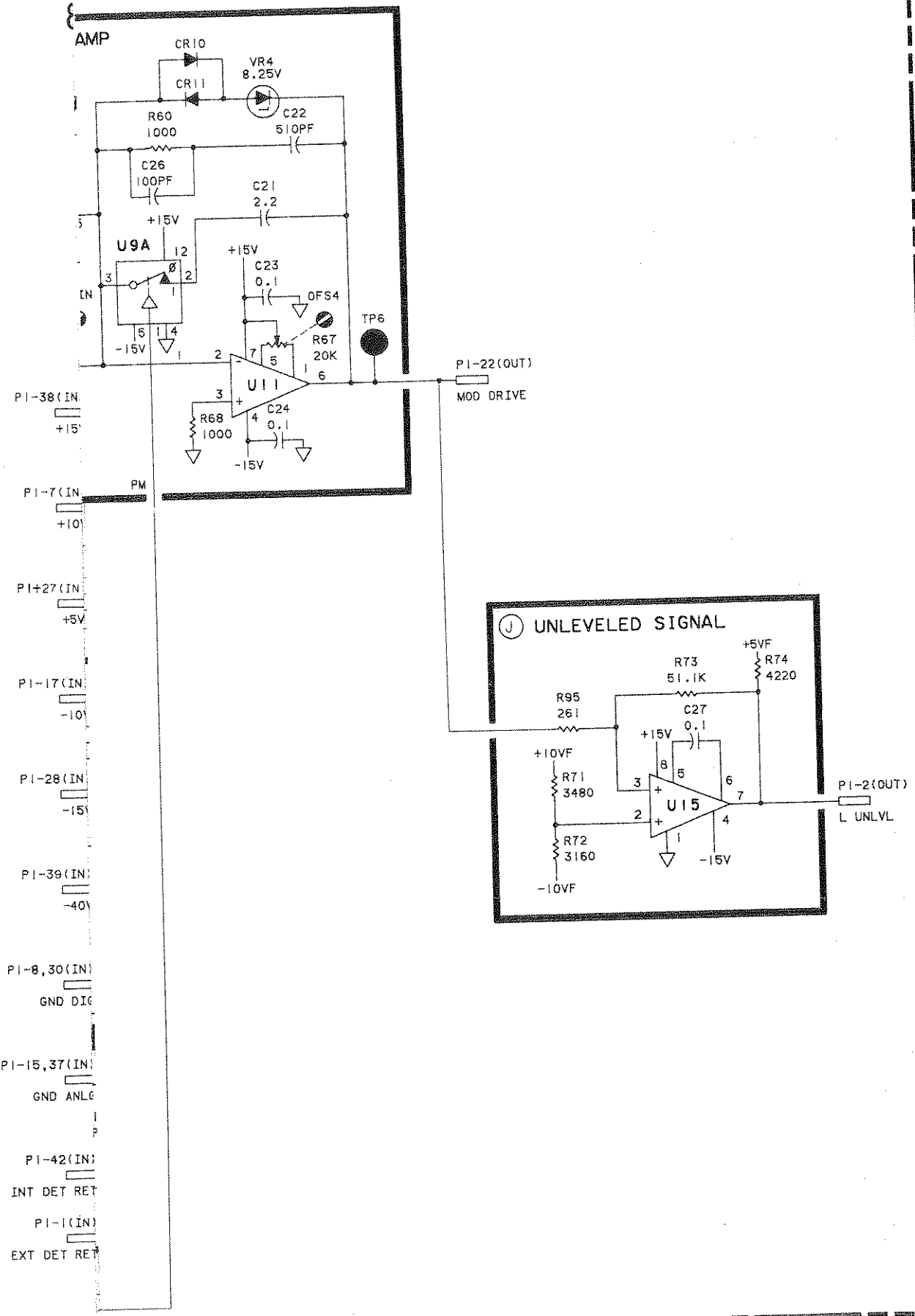

Figure 8-33. A4 ALC, Schematic Diagram (Change E)



CHANGE F

No change.

CHANGE G

This change affect the Motherboard.

Page 6-26, Table 6-3:

Change A8 Motherboard to Part Number 83570-60062, CD 9.

Change A8MP3 to A8MP1.

Change A8MP2 Part Number to 1251-2313, CD 6, and change the Qty to 1.

Delete A8W1 and A8W2, Part Number 8159-0005, CD 0, WIRE 22AWG W PVC 1X22 80C.

Add A8XA2, HP Part Number 1251-1626, CD 2, QTY 1, PC Edge Conn.

Page 8-145/8-146, Figure 8-55:

Replace Figure 8-55 with *Figure 8-55, A8 Motherboard Component Locations (Change G)* from this Manual Backdating Section.

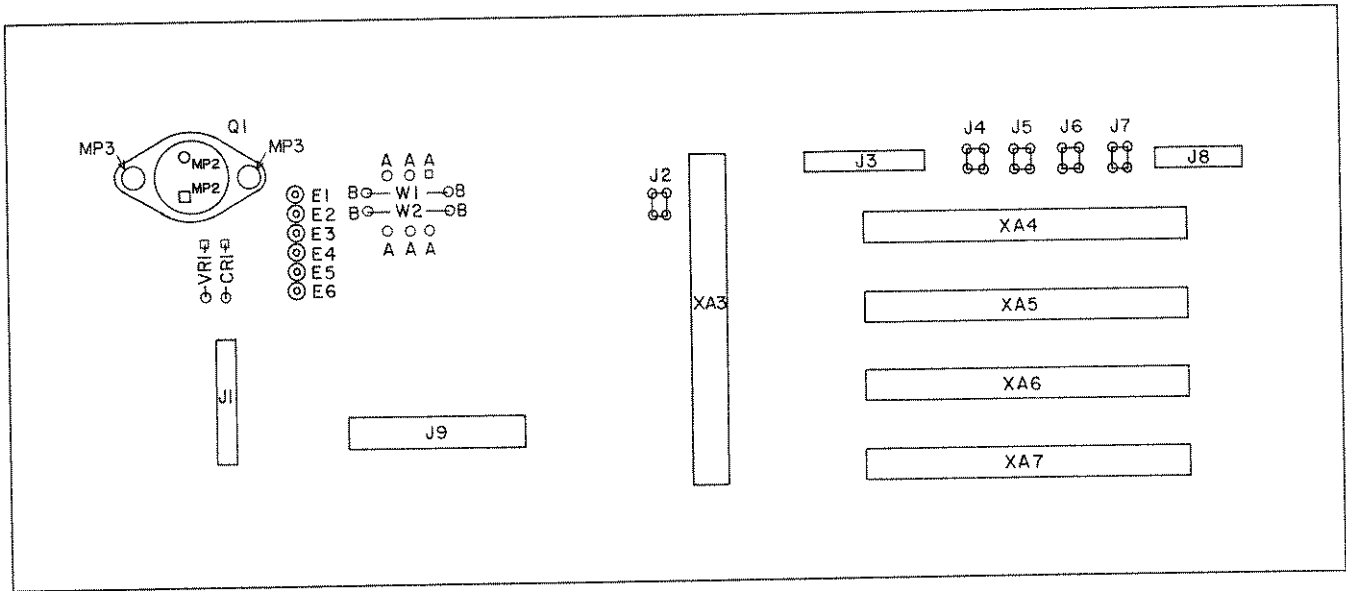

HP Part Number 83570-60062

Figure 8-55. A8 Motherboard Component Locations (Change G)

CHANGE H

This affects the A3 Digital Interface Board.

Page 6-11, Table 6-3:

Change A3 Board Assembly-Digital Interface to HP and Mfr. Part Number 83525-60007, CD 7.

Change A3U1 to HP and Mfr. Part Number 5081-8166, CD 2.

Change A3U2 to HP and Mfr. Part Number 5081-8167, CD 3.

Page 8-63/8-64, Figure 8-23:

On the A3 DIGITAL INTERFACE Schematic, Change the part number in the top left-hand corner of the schematic to 83525-60007.

CHANGE I

This change affects the A7 Bias Assembly

Page 6-23, Table 6-3:

Change A7 BOARD ASSEMBLY-BIAS to HP and Mfr. Part Number 83570-60003, CD 8.

Change A7Q9 to HP Part Number 1855-0423, CD 5, TRANSISTOR MOSFET N-CHAN E MODE.

Delete A7R71.

Page 8-139/8-140, Figure 8-52B:

Replace the Component Locations Diagram with *Figure 8-52B. A7 Bias Assembly Component Locations (CHANGE I)* from this Manual Backdating section.

Figure 8-143/8-144, Figure 8-54:

Replace Block J YIG BIAS with the partial schematic *P/O Figure 8-54, A7 Bias Assembly Schematic Diagram (CHANGE I)* from this Manual Backdating section.

A7

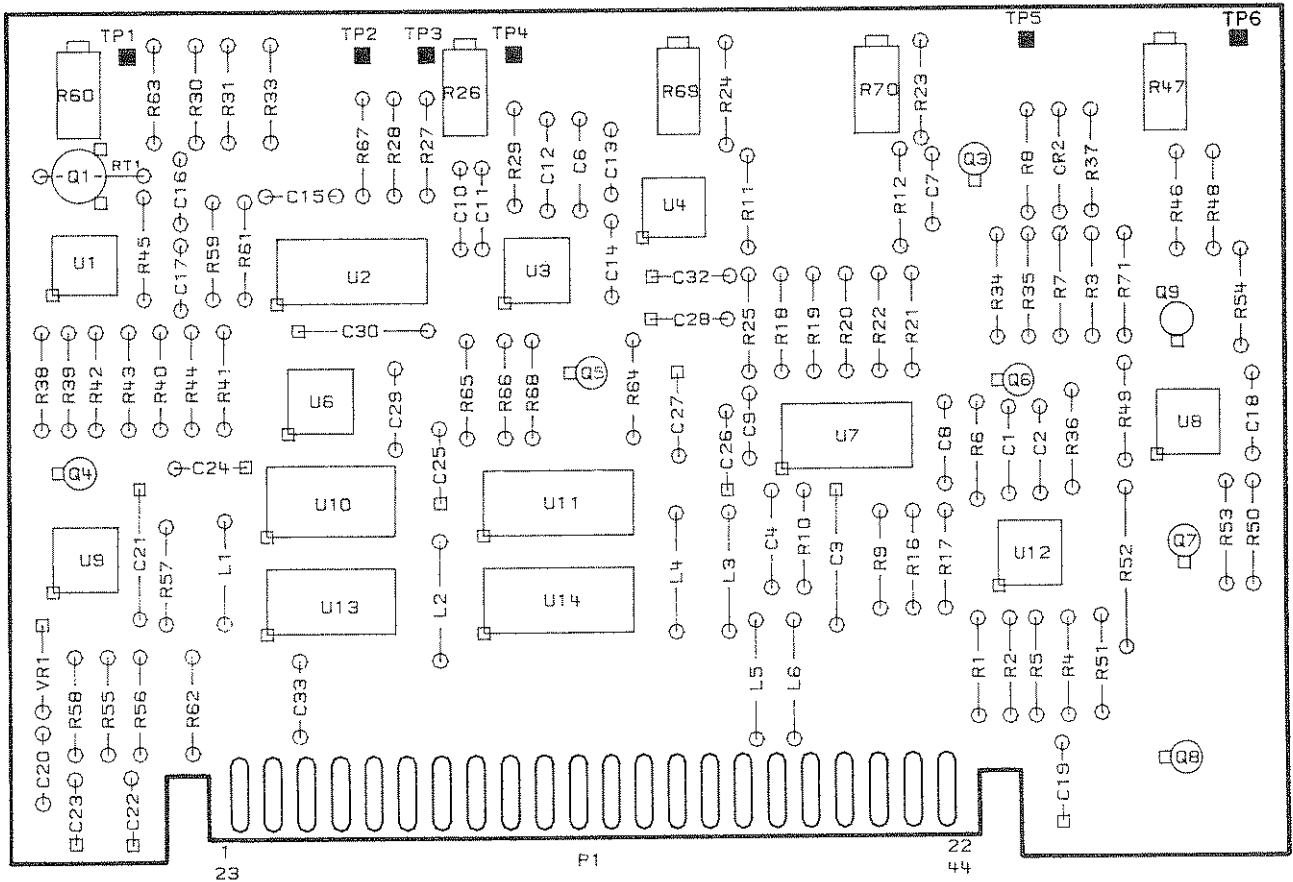

HP Part Number 83570-60003

Figure 8-52B. A7 Bias Assembly Component Locations (Change I)

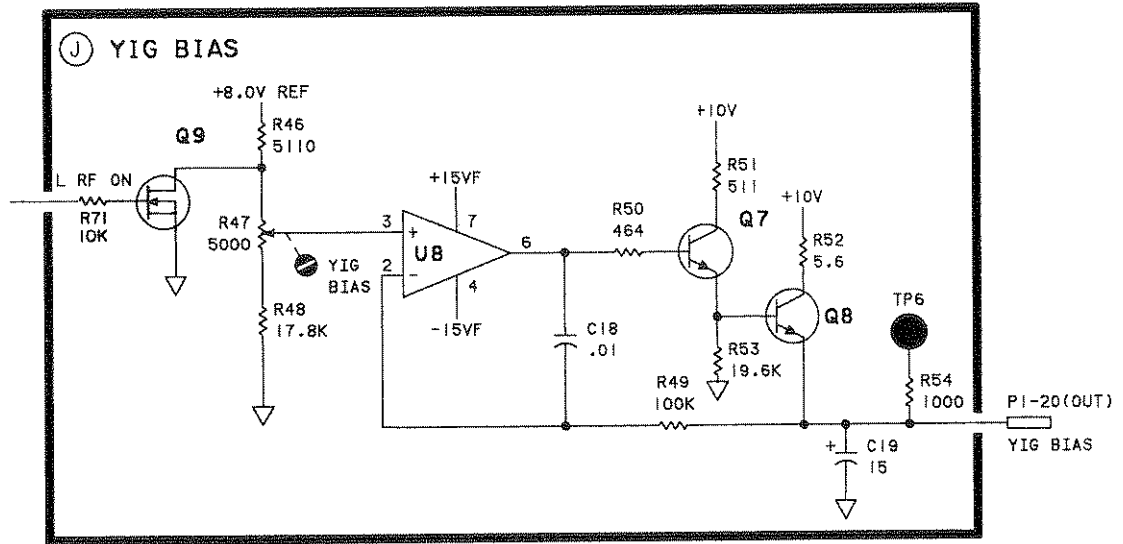

P/O Figure 8-54. A7 Bias Assembly, Schematic Diagram (Change I)

CHANGE J

This change affects the squarewave symmetry of the ALC board.

Page 6-12, Table 6-3:

Change A4 to HP and Mfr. Part Number 83570-60053, CD 8.

Change A4CR4 to HP and Mfr. Part Number 1901-1098, CD 1, DIODE-SWITCHING 1N4150 50V 200mA.

Change A4U7 to HP Part Number 1826-0319, CD 7, IC OP AMP LOW-BIAS-H-IMPED TO-99 PKG.

Page 8-85/8-86, Figure 8-31:

Replace Figure 8-31 with *Figure 8-31. A4 ALC Component Locations (CHANGE J)* from this Manual Backdating section.

Page 9-89/8-90, Figure 8-33:

Replace Block E LOG AMPLIFIER with the partial schematic *P/O Figure 8-33, A4 ALC, Schematic Diagram (Change J)* from this Manual Backdating section.

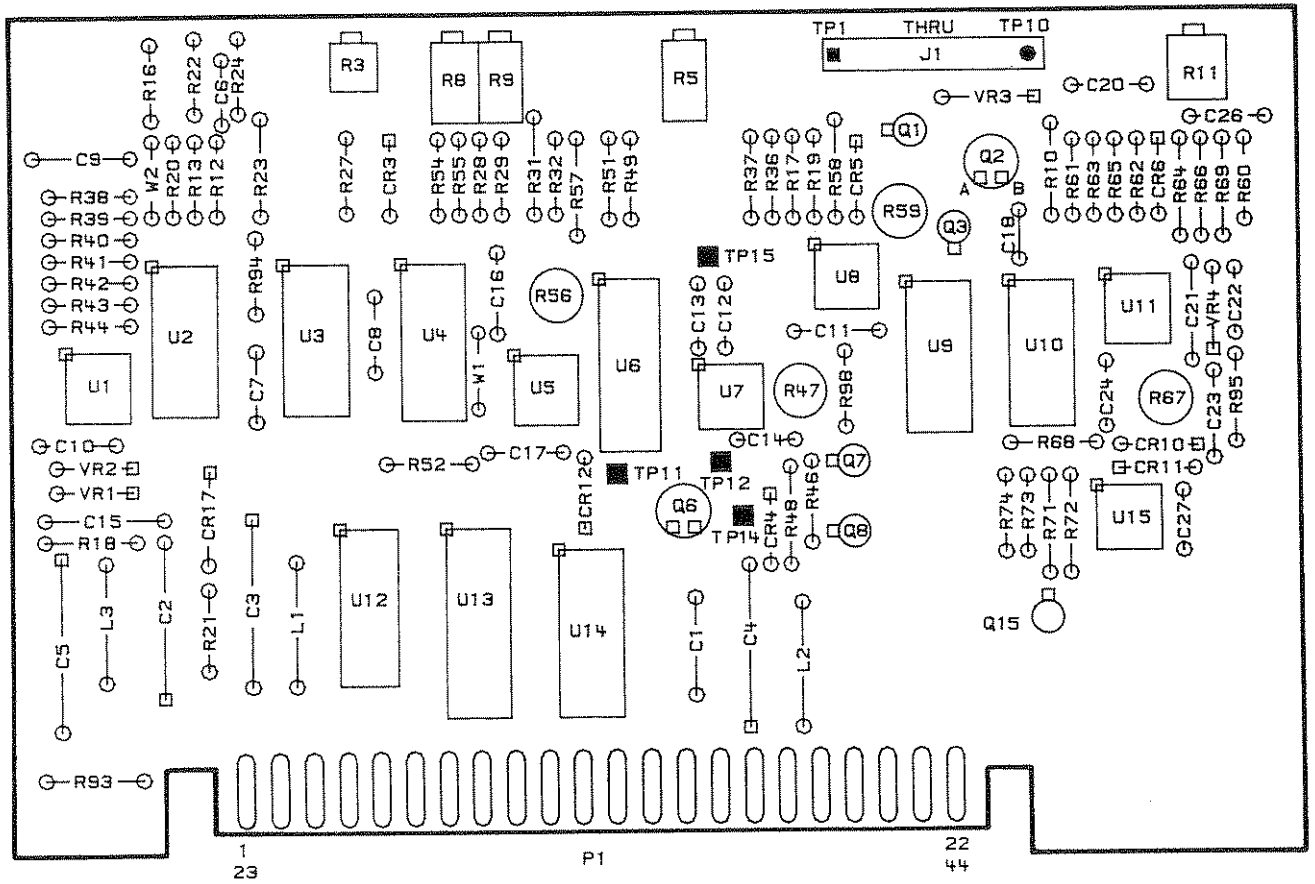

HP Part Number 83570-60053

Figure 8-31. A4 ALC Component Locations (Change J)

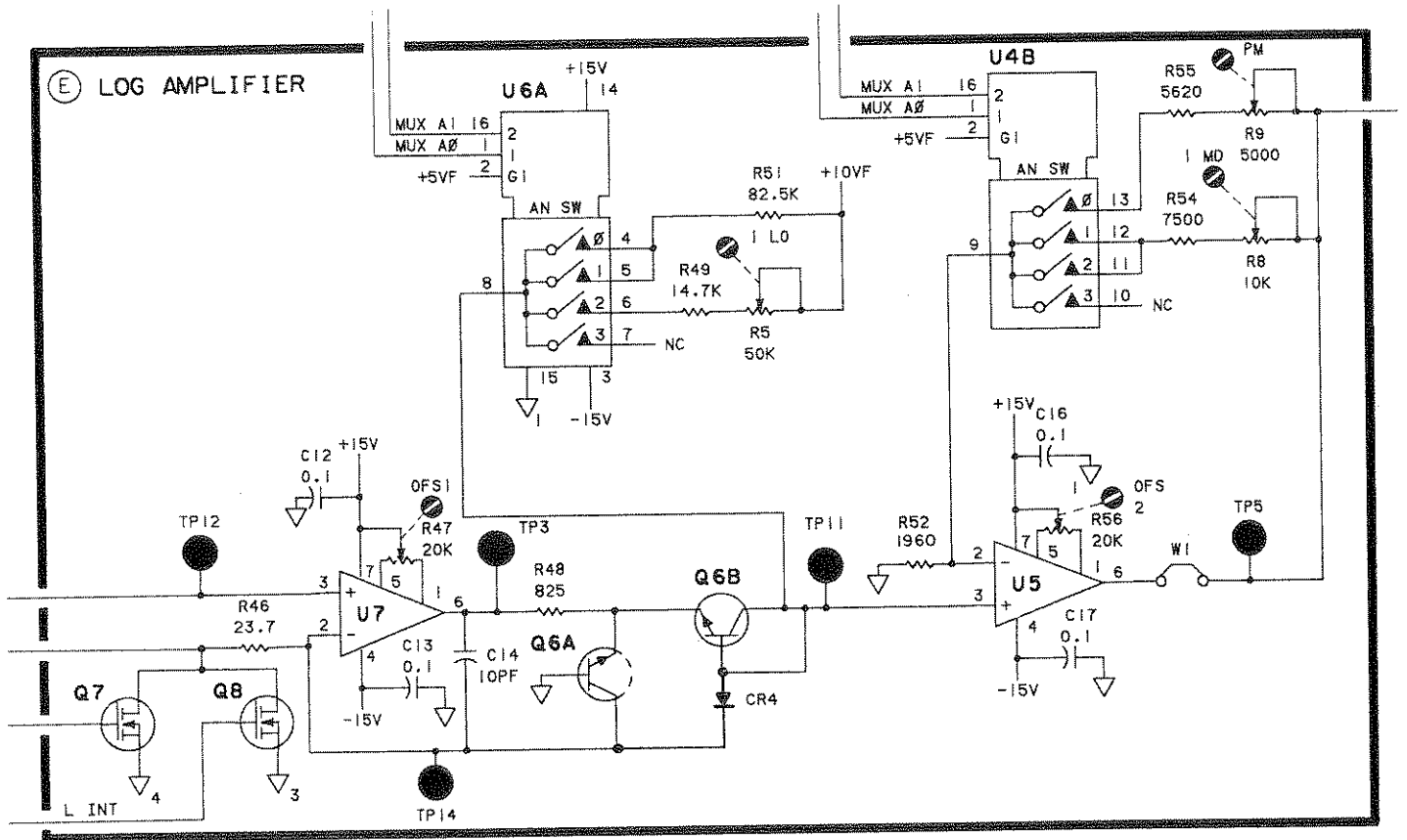

P/O Figure 8-33. A4 ALC Schematic Diagram (Change J)

CHANGE K

No change.

CHANGE L

This change affects the EXT/MTR ALC CAL adjustment on the front panel.

Page 6-6, Table 6-3:

Change A1R1 Part Number to 2100-3766, CD 7.

Add MP8, KNOB-JADE GRAY, HP Part Number 5040-8823, CD 2.

CHANGE M

This change affects the Motherboard Part Number.

Page 6-26, Table 6-3:

Change A8 Motherboard to HP and Mfr. Part Number 083570-60001, CD 6.

CHANGE N

Page 6-11, Table 6-3:

Change A3 to HP Part Number 83570-60007, CD 2.

Change A3U1 to HP Part Number 5081-8170, CD 8.

CHANGE O

No change.

INTRODUCTION

This section provides instructions for troubleshooting and repairing the HP 83570A RF plug-in. Information includes circuit descriptions, troubleshooting procedures, block diagrams, schematics, and component location diagrams for each PC board assembly. Each schematic with the exception of the overall block diagram pertains to a specific assembly and they are arranged in assembly number order.

WARNING

Adjustments or repairs inside the HP 8350/83570A with covers removed and AC power connected should be avoided whenever possible. Any procedure requiring a cover to be removed from the instrument while AC power is connected **SHOULD BE PERFORMED ONLY BY QUALIFIED SERVICE PERSONNEL WHO ARE AWARE OF THE HAZARDS INVOLVED.** With the AC power cable connected to the HP 8350, the line voltage is present on the terminals of the power module (on the rear panel), and at the LINE power switch, regardless of whether the switch is ON or OFF. The AC voltage on these terminals can, if touched, cause personal injury or even death. You must also be aware that capacitors inside the instrument may remain charged even though the instrument has been disconnected from its AC power source.

RECOMMENDED SERVICE ACCESSORIES

Table 8-1 shows those accessories which should be used when servicing this plug-in.

Table 8-1. Recommended Service Accessories

Item	Description	HP Part Number
RMA Solder	Rosin Mildly Activated	8090-0587
Edsyn Silverstat	Low-static solder removal tool	8690-0227
Replacement Tip	For solder removal tool	8690-0253
Wrist Strap	Anti-static wrist strap w/cord	9300-0791
Soldering Iron	Must have grounded tip	N/A

SERVICE AIDS

Two extender cable assemblies, HP part number 08350-60034 (64 pin) and 08350-60035 (17 pin), are designed to power the RF plug-in when it is removed from the HP 8350 sweep oscillator for troubleshooting. These service aids are recommended for convenience in servicing the HP 83570A.

A 44 pin extender board (HP Part No. 08350-60031) is available to allow access to printed circuit board assembly components while maintaining electrical contact with the plug-in. This and other service aids are referenced in Section I, Table 1-3.

TROUBLESHOOTING

Troubleshooting is generally divided into two maintenance levels in this manual. The first level (Overall Theory of Operation and Troubleshooting) helps isolate the problem to a circuit or assembly.

The second maintenance level isolates the trouble to the component. Operator-initiated tests, schematic diagrams, and circuit descriptions for each assembly, aid in troubleshooting to the component level.

SELF-TEST

HP 8350 software provides microprocessor and operator-initiated checks. These checks verify the proper functioning of the majority of the HP 8350 and 83570A digital circuitry and a portion of the analog devices.

Whenever the HP 8350 is powered ON or the front panel INSTR PRESET key is pressed, instrument self-test is initiated. This test checks a number of circuits in both the HP 8350 and the HP 83570A. If a failure in the plug-in is detected during self test, error code E001 will be displayed. Table 8-3 lists other error codes associated with the RF plug-in.

HEXADECIMAL

Hexadecimal is the number system used to locally address the HP 8350 and 83570A logic components. Available operator-initiated self test routines are indexed in Table 8-4.

The hexadecimal system uses 16 digits: 0 1 2 3 4 5 6 7 8 9 A B C D E F. Since 16 is the fourth power of 2, four digit binary numbers can be expressed with a single hexadecimal digit. Therefore an entire 8-bit binary number can be represented with 2 hexadecimal digits. This makes local programming easier. Table 8-2 provides hexadecimal conversions to binary and decimal equivalents.

Table 8-2. Hexadecimal Equivalents

Hexadecimal	Binary	Decimal
0	0000	0
1	0001	1
2	0010	2
3	0011	3
4	0100	4
5	0101	5
6	0110	6
7	0111	7
8	1000	8
9	1001	9
A	1010	10
b	1011	11
C	1100	12
d	1101	13
E	1110	14
F	1111	15

When the HP 8350 is in the hex data write mode, several front panel keys function as hexadecimal digits (A B C D E F). Figure 8-1 illustrates the data entry keyboard with the hexadecimal digits assigned to each key.

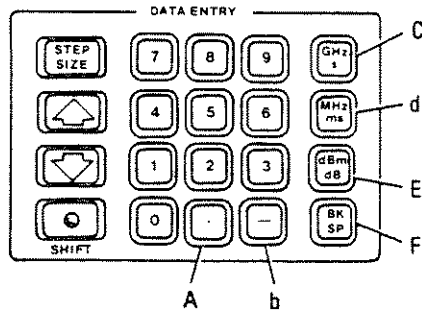

Figure 8-1. Hex Entry Keys

ERROR CODES

RF plug-in error codes are displayed on the HP 8350 left FREQUENCY display. The error codes may be generated as a result of an instrument preset self-test or during normal instrument operation. Table 8-3 lists error codes.

Table 8-3. Error Codes Associated With the HP 83570A

Error Code	Circuit Tested
E001	Addresses 83570A ROM and reads Check Sum back to 8350.
E050	Erroneous Front Panel Pushbutton Flag.
E051	Erroneous Front Panel Pushbutton Code received by 8350 Microprocessor.
E052	Checks for Timer failure in A3.
E053	Checks PIA circuits in A3.
NOTE	
Error codes E050 through E099 are reserved for the RF Plug-ins, however, not all are used.	

OPERATOR-INITIATED TESTS

The HP 8350 microprocessor services several operator-initiated HP 83570A tests in order to check functions which are not exercised during self test. The tests may be initiated by making the appropriate key entry shown in Table 8-4.

Table 8-4. Operator Initiated Self Test Routines

Data Entry	Test	Assembly*	Test Point for Waveform
SHIFT 50	Power Level DAC	A4	A4TP2
SHIFT 51	Power Sweep DAC	A5	A5TP8
SHIFT 52	Scale/Offset DACs	A6	A6TP1/A6TP2
SHIFT 53	Address Decoder: checks major address decoder lines	A3	A3U6, A3U7, A3U9, A3U13
SHIFT 54	Address Decoder: checks individual board address decoders	A6, A7	Address Decoders
SHIFT 55	Interrupt Control	A3	A3U4-38
*Refer to troubleshooting procedure of the appropriate assembly for waveforms and detailed procedures.			
NOTE: The HP 8350 should be in [CW] mode.			

DIRECT COMPONENT ADDRESSING

Direct component addressing is a tool that allows the user to directly access HP 8350 and 83570A input and output devices from the front panel. It allows the user to exercise these devices and thus verify their operation.

The direct component addressing features are shown below with the keystrokes necessary to invoke them. Detailed descriptions of each direct component addressing function are given after the keystroke chart.

Regardless of which direct component addressing function desired, one must first enter the hexadecimal address of the device in question. Schematic diagrams show the addresses for each addressable device. Note the "hex address entry" command below. Once the appropriate address has been entered, choose the direct component addressing function desired.

Command	Key Entry
Enter Device Address	[SHIFT] [0] [0] [M1] (HEX ADDRESS) ¹
Hex Data WRITE	[M2] (2 DIGIT HEX DATA)
Hex Data READ	[M3]
Hex Data Rotation Write	[M4]
Hex Addressed Fast Read	[M5]
<p>¹ The hexadecimal address is a four digit base 16 number. Hexadecimal numbers, and how to enter them, are discussed in the foregoing description HEXADECIMAL. To address a different location, press M1 and enter the new address, or use the up arrow or down arrow keys. By entering the hex address location of a specific device, that device can be exercised.</p>	

NOTE: Before addressing an HP 83570A component, determine whether or not the HP 8350 micro-processor can READ or WRITE to that particular device. One obviously can not read data from an output latch, for instance, but you can write data to it; and make sure its output is correct.

Direct Component Addressing Functions

- HEX DATA WRITE [M2], allows the operator to write any combination of hex data bytes to the addressed device. The outputs can then be checked to see if the device is functioning properly.
- HEX DATA READ [M3], allows the operator to read the outputs of an addressed device.
- HEX DATA ROTATION WRITE [M4], strobes a logic 1 (high state) through a column of logic 0's (low states) on the data lines of the addressed device. In effect, hex data rotation write is a rapid WRITE mode, exercising the addressed device in real time. The microprocessor inputs the data continuously, without servicing interrupts from the rest of the instrument. Latch enable lines, inputs, and outputs can be checked in this mode. Figure 8-2, *Hex Data Rotation Write — Bit Pattern*, illustrates the correct waveforms.
- HEX ADDRESSED FAST READ [M5], provides an operator-initiated check for verification of the data bus, in which the addressed device is clocked in real time. Latch outputs can be traced from the onboard location back through the data bus to the microprocessor. At each buffer, verify proper TTL levels when the enable line goes low (data valid). Enable line waveforms are shown in Figure 8-3, *Hex Addressed Fast Read — Timing Diagram*.

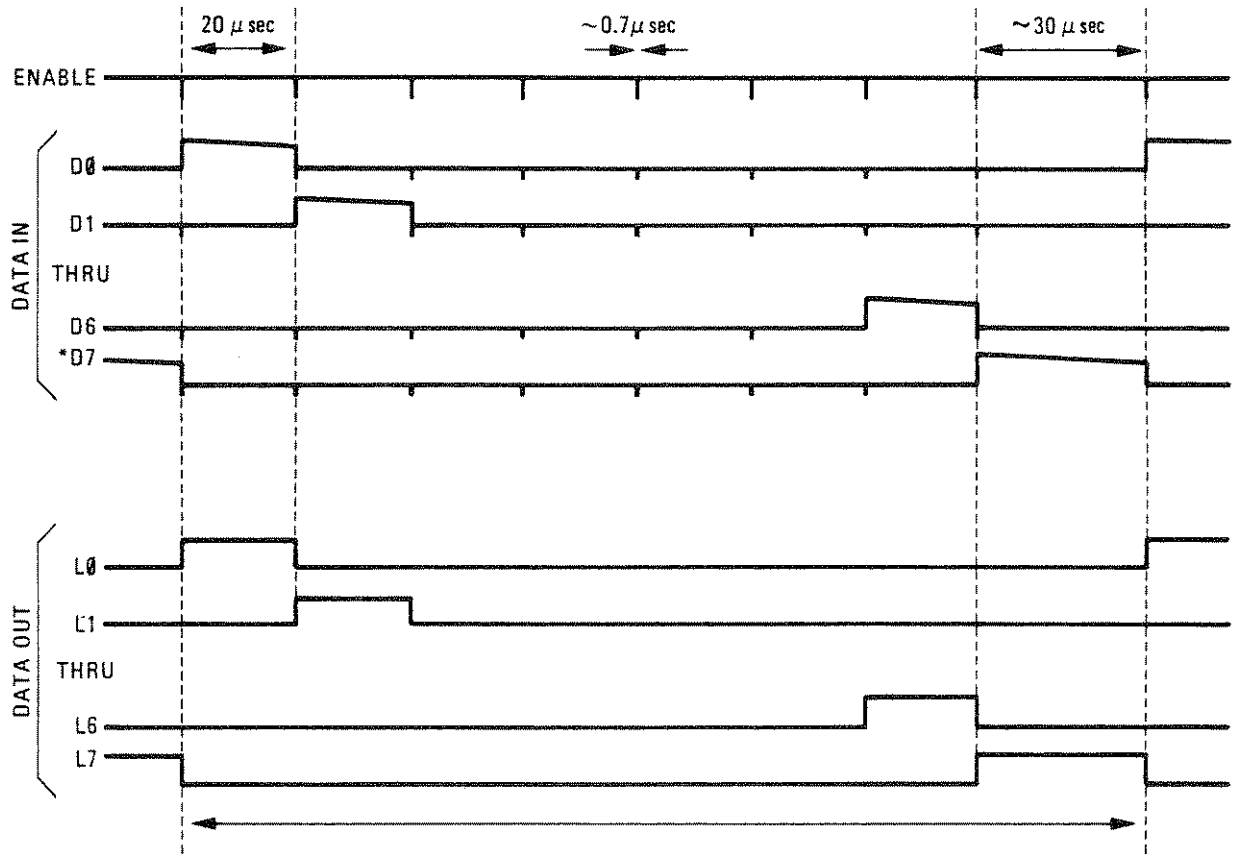

*DURATION OF LAST BIT PULSE IS APPROXIMATELY 30 μSEC DUE TO DELAY BETWEEN RECYCLE.

Figure 8-2. Hex Data Rotation Write — Bit Pattern

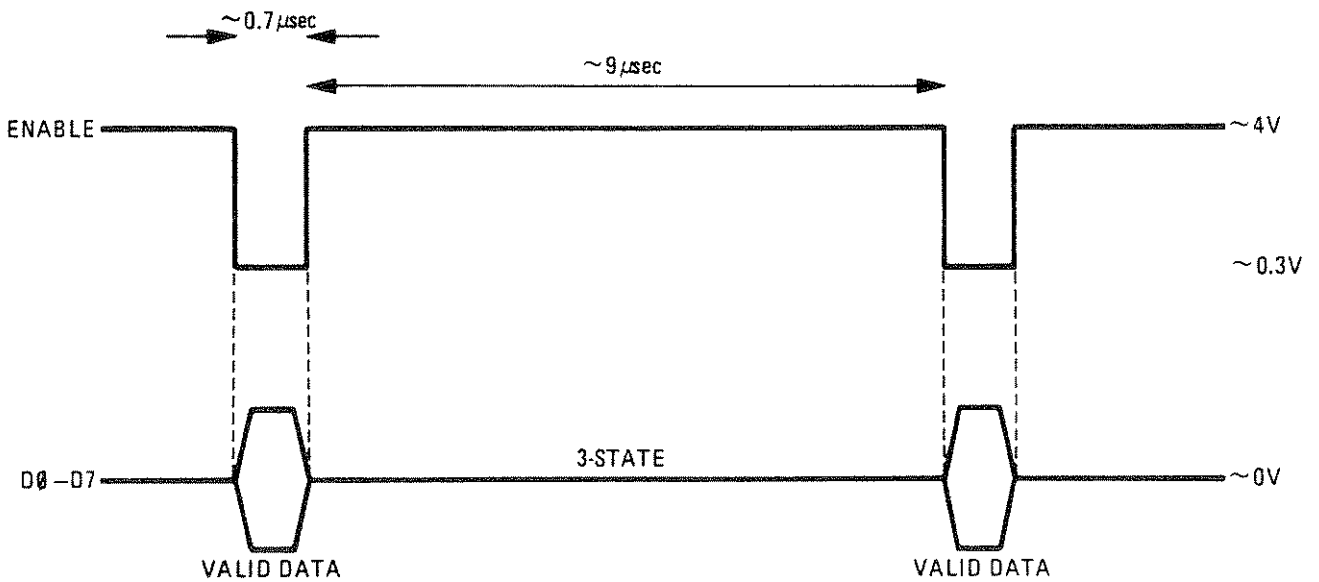

Figure 8-3. Hex Addressed Fast Read — Timing Diagram

TYPES OF FAILURES

Table 8-5, below, shows most common failure symptoms and which assemblies deal with that symptom. Note that the listed assembly is not always the cause.

Table 8-5. Failure Symptoms Vs. Assembly/Related Adjustments

Symptom	Assembly	Related Adjustment
Error codes E050 and E051 Display-related, bad segment, etc. Keyboard-related, key(s) non-functional LED failure Rotary knob (Rotary Pulse Generator, RPG)	A1	N/A
Pulse modulation problems Insufficient RF power output	A2/A4 A2	N/A Internally Leveled Flatness, Doubler Peaking
Error codes E001, E052, and E053 No Error codes, HP 8350 frequency display is correct	A3	N/A
Unleveled power LED ON Output power unleveled Flatness out of specification	A4 A4 A4	N/A ALC Gain Internally Leveled Flatness, ALC Gain
Oscillations No RF power output Power sweep	A4 A4 A4	ALC Gain N/A Power Sweep
Frequency modulation	A5	FM Driver
Frequency errors (>500 MHz) independent of sweep time	A6 ¹	N/A
Frequency errors (>500 MHz) sweep time dependent	A7 ¹	N/A

¹ If the frequency error is <500 MHz, chances are that the plug-in simply needs to be adjusted. Perform the frequency accuracy adjustment in Section V.

RECOMMENDED TEST EQUIPMENT

Test equipment required to maintain the HP 83570A is listed in Section I (Table 1-2). If the equipment listed is not available, equipment that meets the minimum specifications shown in Table 1-2 may be substituted.

REPAIR

CAUTION

This product contains static sensitive components. When handling these components or assemblies, work on an anti-static surface and use an anti-static wrist strap.

Use of low-static solder removal tools are recommended when desoldering components. Only use soldering irons that have a grounded tip.

Do not use silicone-based thermal compound on any internal components! Use of oil-based thermal compound is recommended.

Use only Rosin Mildly Activated solder when repairing a PC board.

Never clean solder flux from a PC board after replacing a component! This may cause serious reliability problems.

NEVER CLEAN PC BOARD FINGER CONTACTS WITH AN ERASER! This seriously damages the thin gold plating on the fingers. If the contacts need to be cleaned, use the following method:

Printed Circuit Board Finger Cleaning Procedure

Mix one part de-ionized water with two parts isopropyl alcohol. Apply this solution to a clean, lint free, cloth (HP Part No. 9310-0039). Rub the fingers carefully and then dry with a clean part of the cloth. **NEVER USE TAP WATER IN THE CLEANING SOLUTION.** See the caution above.

Module Exchange Program

Certain assemblies within this instrument may be replaced with restored-exchange assemblies which are made available at a reduced price. The replacement parts list in Section VI lists the assemblies in this plug-in which are available for module exchange.

The procedure for using the module exchange program is given in Figure 8-4, *Module Exchange Procedure*. When you locate the defective assembly, order a replacement assembly through the nearest Hewlett-Packard sales office. The restored-exchange module will be sent immediately. When you receive the exchange module, return the defective module in the same shipping container in which the exchange assembly was received. **DO NOT RETURN THE DEFECTIVE MODULE TO HEWLETT-PACKARD UNTIL YOU RECEIVE THE EXCHANGE MODULE.**

If you are not going to return the defective module, or if you are ordering a module for spare parts stock, etc., order a new module using the part number listed in Table 6-3.

The Hewlett-Packard module exchange program allows you to obtain a fully tested and warranted restored-exchange module at a reduced price. (The reduced price is contingent upon return of the defective module to Hewlett-Packard.) Assemblies available for module exchange are listed in Table 6-1.

The module exchange program described here is a fast, efficient, economical method of keeping your Hewlett-Packard instrument in service.

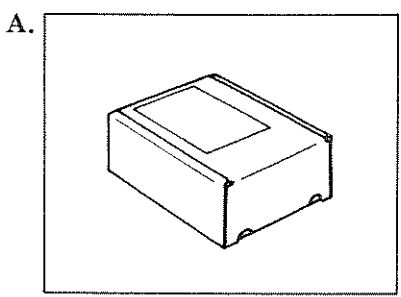
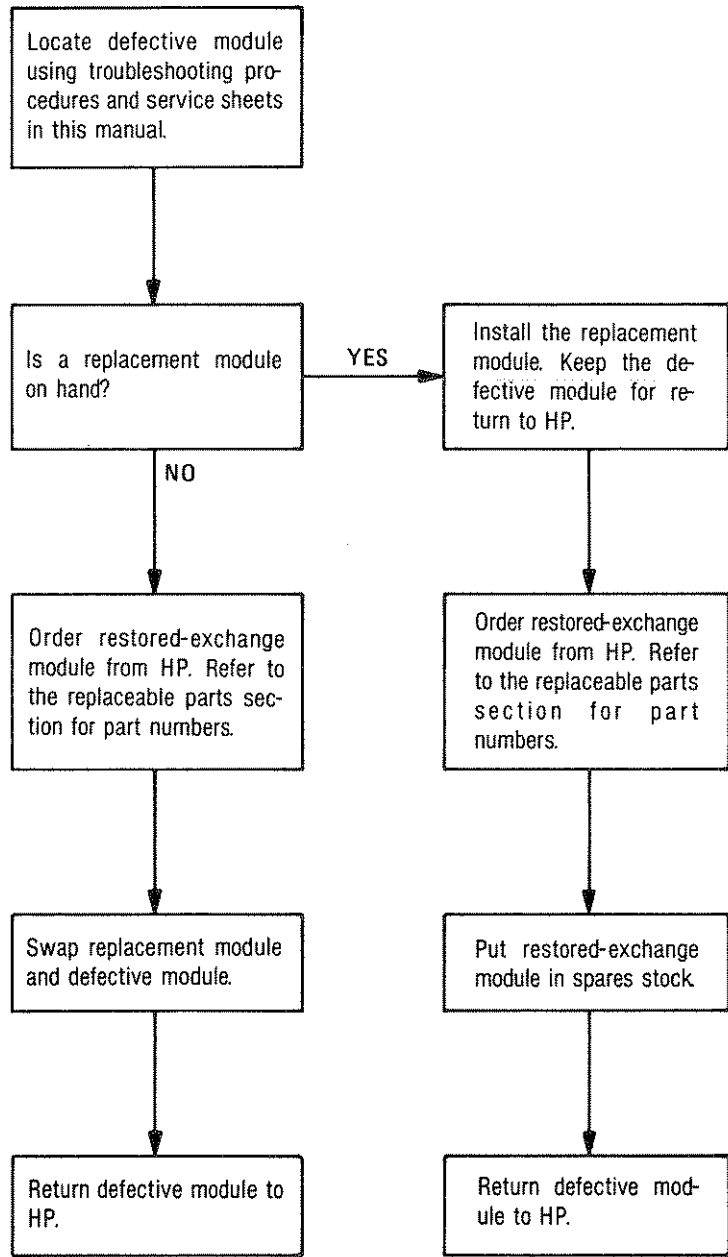

Restored-exchange modules are shipped individually in boxes like this. In addition to the circuit module, the box contains:
Exchange assembly failure report
Return address label

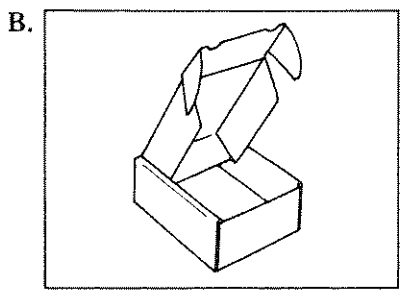

Open box carefully - it will be used to return defective module to HP. Complete failure report. Place it and defective module in box. Be sure to remove enclosed return address label.

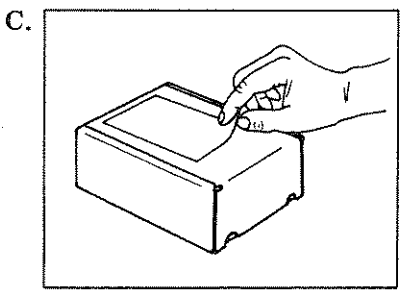

Seal box with tape. Inside U.S.A.*, stick preprinted return address label over label already on box, and return box to HP. Outside U.S.A., do not use address label: instead address box to the nearest HP office.

*HP pays postage on boxes mailed in U.S.A.

Figure 8-4. Module Exchange Procedure

Rear Panel Connector Replacement

When replacing rear panel connector P1, connector P2 must also be partially removed.

When reassembling rear panel connectors P1 and P2, correct positioning is critical to ensure that they align properly with the mating HP 8350 connectors. Align the center of the attaching bolts with a steel rule and tighten in place in accordance with the placement drawing in Figure 8-5.

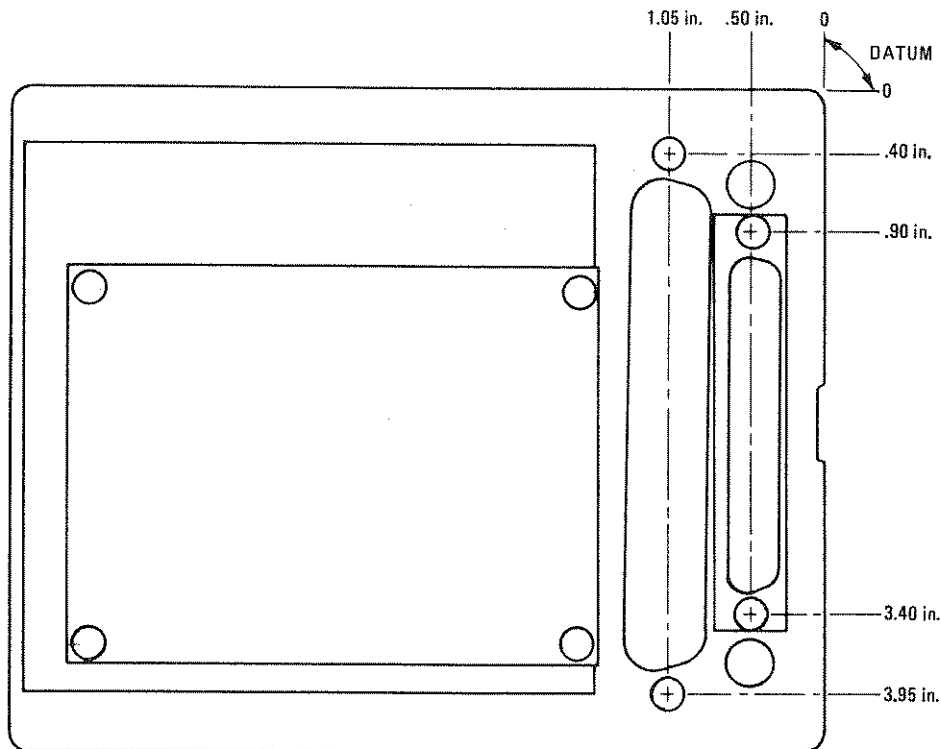

Figure 8-5. Rear Panel Connector Alignment Diagram















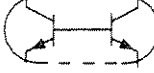













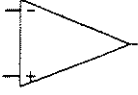











AFTER SERVICE SAFETY CHECKS

Visually inspect the interior of the unit for any signs of abnormal internally generated heat, such as discolored printed circuit boards or components, damaged insulation, or evidence of arcing. Determine and remedy the cause of any such condition.

SCHEMATIC DIAGRAM NOTES

Figure 8-6, *Schematic Diagram Notes*, provides definitions to schematic symbols.

BASIC COMPONENT SYMBOLOGY

R, L, C	Resistance is in ohms, inductance is in microhenries, capacitance is in microfarads, unless otherwise noted.		Pin Edge Connector output of PC board.		FET: Field Effect Transistor (N-channel).
P/O	Part of.		Indicates wire or cable color code. Color code same as resistor color code. First number indicates base color, second and third numbers indicate colored stripes.		FET: Field Effect Transistor-Guarded gate (N channel).
*	Indicates a factory selected component.		Indicates shielding conductor for cables.		Dual Transistor.
	Panel Control.		Indicates a plug-in connection.		Transistor NPN
	Screwdriver adjustment.		Indicates a soldered or mechanical connection.		Transistor PNP
	Encloses front panel designation.		Connection symbol indicating a male connection.		Electrolytic Capacitor.
	Encloses rear panel designation.		Connection symbol indicating a female connection.		Toroid: Magnetic core inductor.
	Circuit assembly border-line.		Resistor.		Operational Amplifier.
	Other assembly border-line.		Variable Resistor.		Fuse
	Heavy line with arrows indicates path and direction of main signal.		General purpose diode.		Pushbutton Switch.
	Indicates path and direction of main feedback.		Schottky diode.		Toggle Switch.
	Earth ground symbol.		Breakdown Diode: Zener		Thermal Switch.
	Assembly ground. May be accompanied by a number or letter to specify a particular ground.		Light-Emitting Diode.		Summing Point.
	Chassis ground.		SCR (Silicon Controlled Rectifier).		Oscillator; RPG (Rotary Pulse Generator).
	Represents n number of transmission paths.		Fan, Motor.		Toroidal Transformer
	Test Point: Terminal provided for test probe.				

LOGIC SYMBOLY









	AND Gate		NOR Gate		Inverter
	OR Gate		Exclusive OR Gate		Negation symbol. Line is active low.
	NAND Gate		Buffer/Amplifier		Indicated edge-sensitive input.

Figure 8-6. Schematic Diagram Notes (1 of 3)

INTEGRATED CIRCUIT SYMBOLOGY



Schmitt Trigger: The gate of the Schmitt Trigger switches at different points for positive - and negative-going signals. The difference between the positive and negative thresholds is defined as hysteresis voltage.

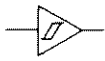
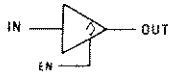

3-State Buffer: Three States:
 Enable (EN) Input low: High impedance output.
 Enable input high: Output = 0 or Output = 1

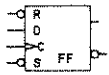

Data Flip-Flop: Set (S) and Reset (R) are asynchronous controls. Active S sets the noninverting output high and the inverting output (O-) low; active R resets both outputs. When S and R are both inactive, the outputs remain latched in the last state. An active clock (C) enables the D input, at which time the noninverting output = D, and the inverting output = \bar{D} .

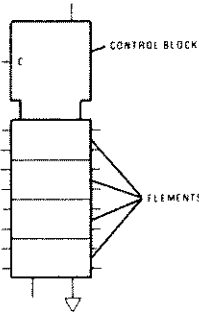

Control Block: All controlling inputs (gates, clocks, inhibits, etc.) connect to the control block.
Elements: Can be one or more of any logic function (flip-flop, counter, gate, RAM, etc.). Data inputs are on the left side of element, data outputs on the right.

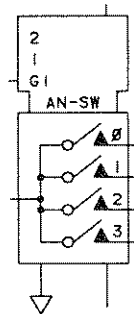

Analog Switch: Control lines 1 and 2 decode to select one of four inputs. G1, high=enable.

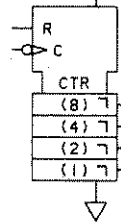

Counter: Binary-weighted registers count on the falling edge of each clock pulse. Active (high) R clears all registers.

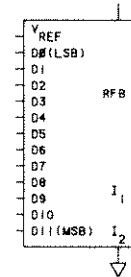

Digital to Analog Converter (DAC): Provides a scaled current output (I_1), the product of V_{REF} and the fractional binary input:
 $D_{11}2^{-1} + D_{10}2^{-2} + D_92^{-3} + \dots D_02^{-12}$
 The product of V_{REF} and complement of the binary input appears at I_2 .

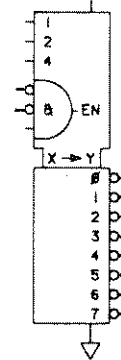

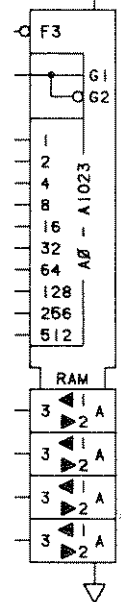

Decoder: The logic states of the three select lines A, B, and C, and the three enable inputs (EN), determine which one of the eight outputs will be decoded. The selected output will be low, while all others are high.



Random-Access Memory (RAM): Binary addresses (A0 to A9) access one of 1024 registers in RAM. When G1 is high, bits appearing at D0 to D3 will be written to the addressed location (A0 to A9). When G2 is low, bits appearing at D0 to D3 have been accessed from the addressed location.

Figure 8-6. Schematic Diagram Notes (2 of 3)

FUNCTION LABEL ABBREVIATIONS		
Σ	Adder	\diamond Open Collector
	Amplifier/Buffer	 Monostable Multivibrator
	Schmitt Trigger	BCD Binary Coded Decimal
&	AND	CTR Counter
≥ 1	OR	DAC Digital-to-Analog Converter
=1	Exclusive OR	FF Flip-Flop
X→Y	Encoder, Decoder	I/O Input/Output
		LED Light-Emitting Diode
		MUX Multiplexer
		RAM Random-Access Memory
		REG Register
		ROM Read Only Memory
		RPG Rotary Pulse Generator

LINE LABEL ABBREVIATIONS		
CK, C	Clock Input	MSB Most Significant Bit
D	Data or Delay Input (Flip-Flop)	Q Output
EN	Enable	\overline{Q} Not Q Complement of Q
F	3-State Enable Input	R Reset or Clear Input
G	Gating Input	RD Read
LSB	Least Significant Bit	S Set Input
		T Trigger Input (Monostable)
		WR Write
		+1 Count Up
		-1 Count Down
		3-ST 3-State (placed by function)

Figure 8-6. Schematic Diagram Notes (3 of 3)

MNEMONICS

Table 8-11 lists alphabetically and defines all HP 83570A signal mnemonics, references the point-to-point distribution of each signal to and from the PC board sockets and the cable connectors on the A8 motherboard assembly, and identifies the signal source. This table is located with the A8 motherboard assembly information found in this section.

REPLACING A9 YIG OSCILLATOR, A6 YO DRIVER, A7 YO BIAS, OR A2 DOUBLER ASSEMBLIES

A6 YO Driver, A7 YO Bias Assemblies

Each YIG oscillator requires a unique set of six resistors to be installed in the A6 YO driver for proper YIG coil drive. To maintain linear response of the YO magnets, four resistors are selected to characterize the necessary exponential compensation on the A7 YO bias assembly. The value of these resistors is documented on a label attached to the side of the HP 83570A near the RF section. If the A6 YO driver is replaced, six resistors (A6R1, A6R3, A6R38, A6R39, A6R40, and A6R41) must be removed from the old board and installed on the new board. Likewise, if the A7 YO bias assembly is replaced, four resistors (A7R38, A7R39, A7R42, A7R43) must be transferred from the old board to the new board.

A9 YIG Oscillator

If the A9 YIG oscillator is replaced, the ten new resistors shipped with the oscillator must be installed on the A6 YO driver and A7 YO bias assemblies in place of the old resistors. In some instances, some of the A6 resistors may be deleted, depending on the drive requirements of the new YIG oscillator.

A2 Doubler Assembly

The mod driver circuit is located on the A2A1 pulse assembly, attached directly to the A2 doubler microcircuit. The internal RF modulator is inside the A2 microcircuit and cannot be replaced separately. The A2 microcircuit and A2A1 pulse assembly are not separately replaceable.

Overall Block Diagram Description

INTRODUCTION

The HP 83570A RF plug-in used with the HP 8350 sweep oscillator, covers the 18.0 to 26.5 GHz frequency range with +10 dBm of leveled RF power. In addition to internal leveling, external detectors or power meters may be used to level the RF power. Furthermore, the HP 83570A can sweep output power proportional to swept frequency.

The HP 83570A can be broken down into three functional sections:

- Digital Control
- Frequency Control
- Power Control

The functional descriptions of each of these three sections follow.

DIGITAL CONTROL

Two assemblies make up the digital control block of the HP 83570A: the A3 digital interface assembly and the A1 front panel assembly.

The entire HP 83570A is digitally controlled by the HP 8350 microprocessor. Very few functions take place without microprocessor intervention. The A3 digital interface assembly of the HP 83570A is therefore the focal point of all communication between plug-in and mainframe. Commands from the HP 8350 are received over the instrument bus, decoded, and routed to the appropriate part of the plug-in. The digital control section also contains a section of read only memory (ROM) which provides the microprocessor with the constants and program software specific to the HP 83570A plug-in.

The A1 front panel assembly is the communication link between the front panel displays or controls and, via the HP 8350 microprocessor, the rest of the plug-in. It receives and stores information to be presented by the numerical display or annunciators through the digital control block, and continuously refreshes the display. User commands are received through the front panel pushbuttons and rotary pulse generator (RPG), and are sent back through the digital control block to the HP 8350 microprocessor.

FREQUENCY CONTROL

The frequency control section, located on the A6 YO driver assembly, is responsible for converting the tuning voltage ramp from the HP 8350 sweep oscillator into a drive current controlling the A9 YIG oscillator (YO) frequency. The tuning voltage is digitally scaled and offset to yield the voltage (current) necessary for the output frequency to equal the programmed frequency. Delay compensation signals from the A7 bias assembly are summed with the scaled tuning voltage to compensate for response delays in the YO.

The external frequency modulation (FM) signal on the A5 FM driver assembly is split into high and low frequency components. The high-frequency portion cannot be summed in with the main drive signal due to limited frequency response of the YO main coil, so it is separately filtered, amplified, and frequency compensated before being applied to a separate FM coil in the YO. The low-frequency and DC portions of the FM signal are summed with the main coil drive signal to produce a total YO control voltage. This voltage is then converted to a current to drive the YIG oscillator.

The 9 to 13.25 GHz output from the A9 YIG oscillator passes to the A2 doubler assembly where the frequency is multiplied by two. This doubled signal is low-pass filtered to eliminate any unwanted harmonics.

POWER CONTROL

The power control circuits on the A4 ALC assembly determine the RF output power level, and ensure that the power is constant across the sweep. A detector on the A2 doubler assembly detects the RF power level, compares it with a reference voltage, and adjusts modulator diodes on the A2A1 pulse assembly in the RF path to correct for amplitude errors.

Both the nominal power level and a scaled sweep ramp (for power slope or power sweep) are digitally programmed from the HP 8350 sweep oscillator. These two signals are summed along with any AM signal to yield a reference power level.

An internal RF detector provides a voltage proportional to the actual RF power level. This is then compared to the desired reference power level voltage to produce an error voltage. The error is amplified and converted to a current drive for the ALC modulator which corrects output power level.

83570A RF PLUG-IN OVERALL BLOCK DIAGRAM

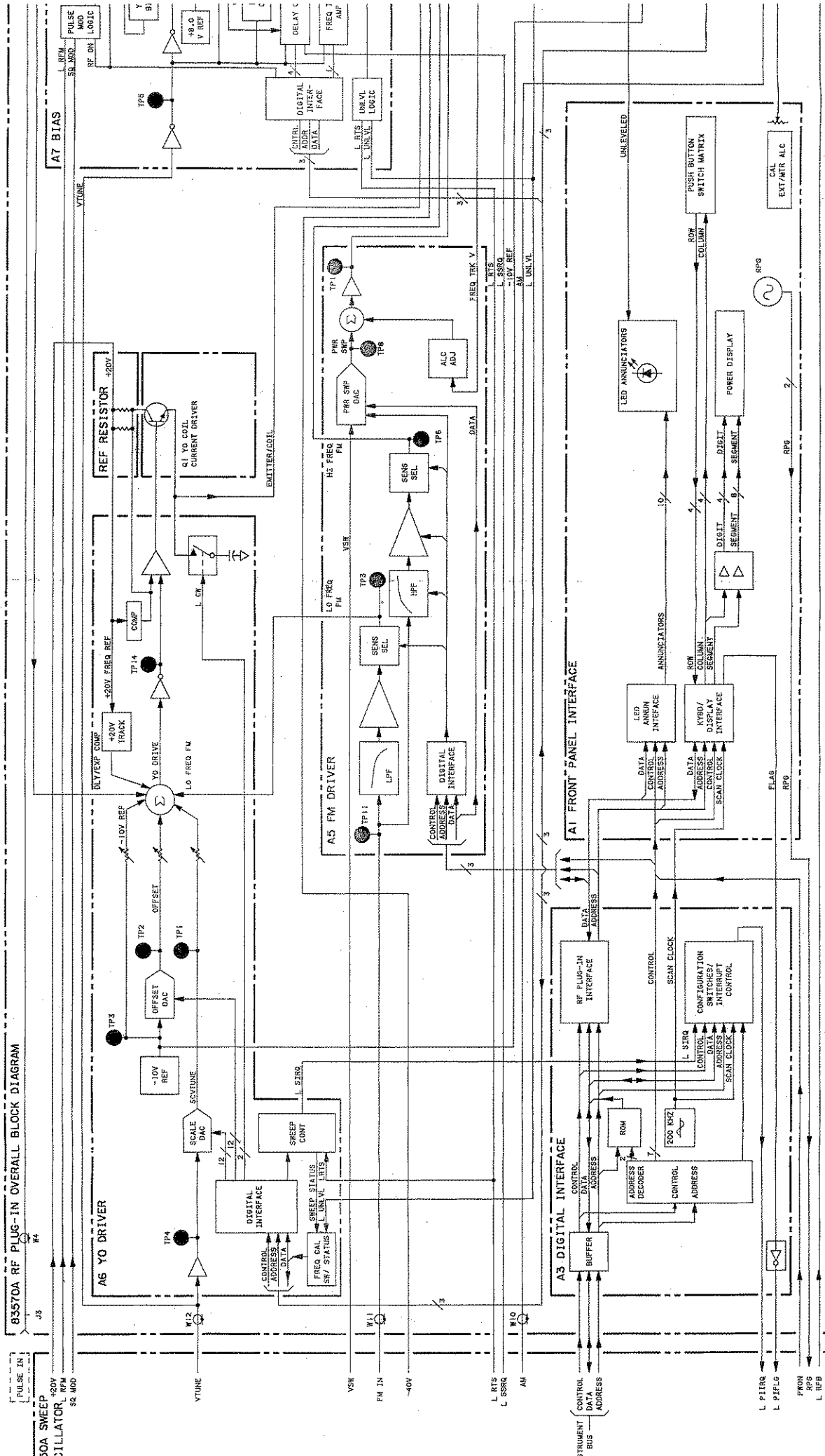

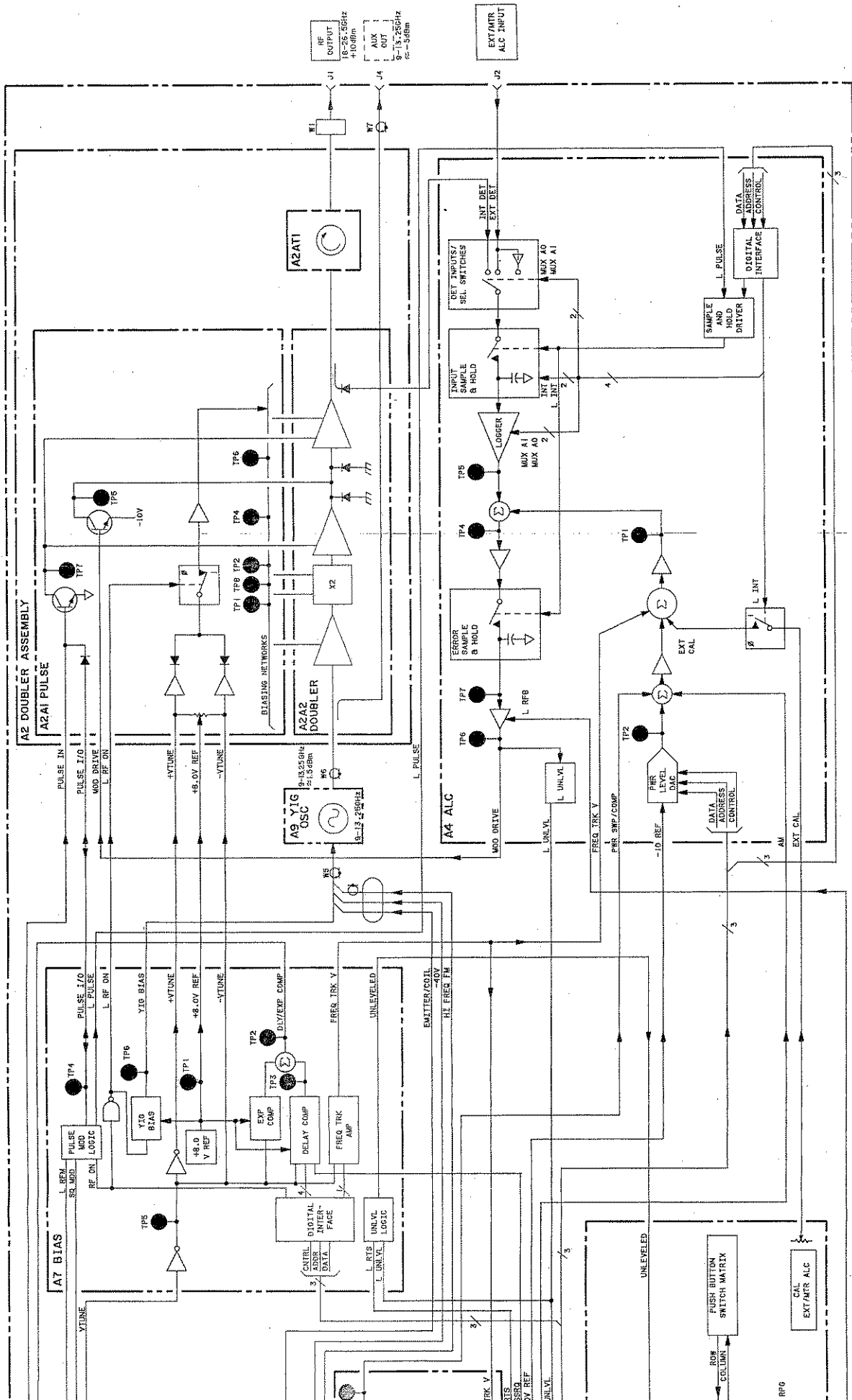

Figure 8-7. HP 88370A Overall Block Diagram
8-10/18-20

A1 Front Panel Troubleshooting

INTRODUCTION

NOTE: The entire plug-in depends on the A3 digital interface assembly for control, address, and data signals. Before troubleshooting the A1 assembly, verify proper functioning of the A3 digital interface. If no error code is displayed, the plug-in has passed self test. This means that A3 digital interface ROM is good, as well as the data bus, address bus, major timing lines, and ROM address decoding are functional. Self test does not verify the A3 digital interface's L PIFLG, FLAG, or PIIRQ lines, nor does it test the internal data (BD0-BD7) and address (BA0-BA3) busses.

Visually inspect the cabling inside the plug-in for damage or loose connections. Check that the large ribbon cable connectors (W8, P1, and P2) are properly seated over the correct pins on motherboard A8J3 and A3 digital interface A3J1. Check that W2 ribbon cable connectors are securely seated over A8J1 and A1J1.

Check power supplies to the front panel: +5V at A8XA3, pins 6 and 7. Then check continuity between these points and A8J1, pin 2.

ERROR CODES E050 AND E051

Error codes E050 and E051 indicate a communication problem between the front panel interface assembly and the HP 8350 microprocessor. Code implications and further troubleshooting hints are discussed later, under the subheading **Keyboard**.

DIGITAL DISPLAY

The plug-in display can be directly commanded by the HP 8350 microprocessor using the hex data write command. An effective test pattern can be input which toggles the states of adjacent segment lines. The pattern should detect shorted lines or a defective flip-flop. Press the HP 8350 **[CW]** key followed by the key sequence below:

[SHIFT] [0] [0] [2] [MHZ ms] [0] [0] [M2] [5] [5] [.] [.] [5] [5] [.] [.]	Direct Component Address mode Address location 2d00 (A1U6) Hex Data Write mode Writes four hex bytes: 55 AA 55 AA
--	--

The pattern seen in the plug-in display should match that shown in Figure 8-8, *Display Test Pattern*, below. If the test fails, check the 200 kHz SCAN CLK at A1U6, pin 3. (This signal is accessible when operating the plug-in outside the HP 8350 with the use of the cables listed in Table 1-3. If these are not available, you may choose to remove the plug-in's front panel assembly as described at the end of this troubleshooting section.) If no signal is detected, trace the line back through A1U5C to the A3 digital interface assembly.

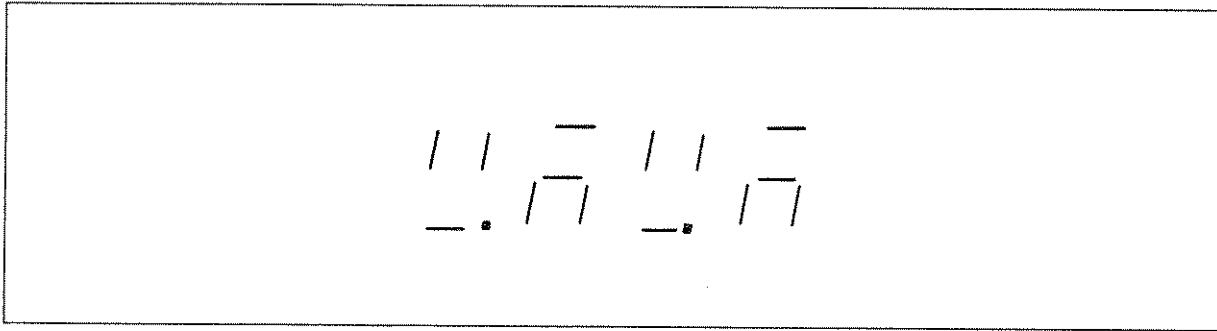

Figure 8-8. Display Test Pattern

Check DIG1 through DIG4 lines for sequential low pulses. If they are absent, trace the problem back to A1U6.

The seven segment lines, Ca through Cg, and Cdp, can be tested by programming the test pattern in Figure 8-8, then verifying activity at the output of A1U1. Trace any problems back to A1U6.

To check for burned out display LEDs, make the key entry outlined above, but enter the following data: [0] [0] [0] [0] [0] [0] [0] [0]. All segments and decimal points should be lit.

Display problems may be due to A3 digital interface failures. Check the L FP1 line at A1U6, pin 11, using hex data rotation write:

<p>[SHIFT] [0] [0] [2] [MHz ms] [0] [0] [M4]</p>	<p>Direct Component Address mode Address location 2d00 (A1U6) Hex Data Rotation Write</p>
--	---

The data lines should also be checked in this mode. (Input and output patterns are illustrated in Figure 8-2, Hex Data Rotation Write – Bit Pattern.) Trace any problems back through A3.

ANNUNCIATORS

Check for burned out LEDs by pressing and holding the [INSTR PRESET] key on the HP 8350. All LEDs should light except for the UNLEVELED LED and the units indicators (dBm, dB/GHz, and dB/SWP).

To check annunciator control capability use the hex data write feature as follows: Press [CW] on the HP 8350 and enter:

<p>[SHIFT] [0] [0] [2] [dBm dB] [0] [0] [M2] [5] [5] [.] [.]</p>	<p>Direct Component Address mode address location 2E00 (A1U9) Hex Data Write mode Write Hex Data value 55 Write Hex Data value AA</p>
--	---

Alternate between 55 and AA and make sure that alternating annunciators go on and off. The alternating pattern is used to make sure adjacent LEDs are not shorted together. This data write does not access the UNLEVELED LED. Repeat this procedure while addressing 2E80 (A1U8).

If these tests fail, remove the front panel assembly as described at the end of this section and expose the backside of the A1 assembly. Use hex data rotation write as follows:

[SHIFT] [0] [0] [2] [dBm dB] [0] [0] [M4]	Direct Component Address mode Address location 2E00 (A1U9) Hex Data Rotation Write
--	--

Check the enable lines for activity. The data bus inputs and latched outputs should also be checked for the patterns illustrated in Figure 8-2. Units annunciators are buffered by inverters whose outputs can be checked during hex data rotation write.

The UNLEVELED LED is driven by a pulse stretching timer on the A7 bias assembly. Refer to the A7 service sheet for further aid in troubleshooting this plug-in's UNLEVELED indicator.

KEYBOARD

The keyboard matrix is scanned continuously by A1U6. This device continuously strobes column lines, senses the row lines for depressed keys, eliminates contact bounce, stores the key code internally, and flags the HP 8350 processor to read the key code. Troubleshooting is difficult because the device is so complex, but it is worthwhile to check all signals to and from A1U6, probing directly on the IC's pins before replacing it.

Error Codes E050 and E051 generally indicate A1U6-related problems:

- E050 occurs when the HP 8350 processor has received a flag (L PIFLG) from the plug-in (indicating that a key has been pressed), but cannot recover the key code. Check the FLAG output from A1U6 (accessible at A3P1-42). It should be TTL low, approximately 0 volts. Pressing a front panel key should result in a very rapid pulse. If the line appears to remain high, replace A1U6. If not, check inverter A3U10F (accessible at A3J1-39) to see if it is locked low.
- E051 occurs when the key code received by the HP 8350 processor cannot be decoded. This indicates a failure in A1U6 or a bad row sense line. If the row sense lines are good, troubleshoot the keyboard matrix with a continuity checker.

To troubleshoot the plug-in keyboard matrix, initiate the key code test, **[SHIFT] [0] [4]**. Thereafter, when pressing any plug-in front panel key, the appropriate hexadecimal key code should appear in the HP 8350 FREQUENCY/TIME display window. The appropriate key codes are given in Table 8-6, *HP 83570A Key Codes*.

Table 8-6. HP 83570A Key Codes

Key	Code	Column	Row
Power Sweep	9b	0	0
Power Level	9A	0	1
SLOPE	99	0	2
RF	98	0	3
CW FILTER	92	1	1
Not Used	91	1	2
Not Used	90	1	3
Not Used	8b	2	0
Not Used	8A	2	1
Not Used	89	2	2
Not Used	88	2	3
INT	82	3	1
EXT	81	3	2
MTR	80	3	3

If pressing a key results in the wrong key code being displayed, troubleshoot the associated column and row lines with a continuity checker. If the matrix lines are good, suspect A1U6.

No key code is defined for Row 0 at Column 1 or Column 3. A problem in this area of the matrix may result in Error Code E051.

If this test indicates that further troubleshooting is necessary, proceed as follows: remove the front panel as described at the end of this section to make A1 accessible while operating the instrument.

If the numeric display is blank, check power supplies on A1.

Check A1U6, pin 3 for the 200 kHz SCAN CLK signal. If it is missing, trace the problem back through A1U5C to the A3 digital interface.

Initiate hex data rotation write and check the L FP2 line for activity:

[SHIFT] [0] [0] [2] [MHz ms] [8] [0] [M4]	Direct Component Address mode Address location 2d80 (U6) Hex Data Rotation Write
---	--

The data line inputs should also be checked in this mode. The pattern should match that shown in Figure 8-2.

Check the COL0 through COL3 lines for sequential low pulses, as shown in Figure 8-9, *Column Strobing*.

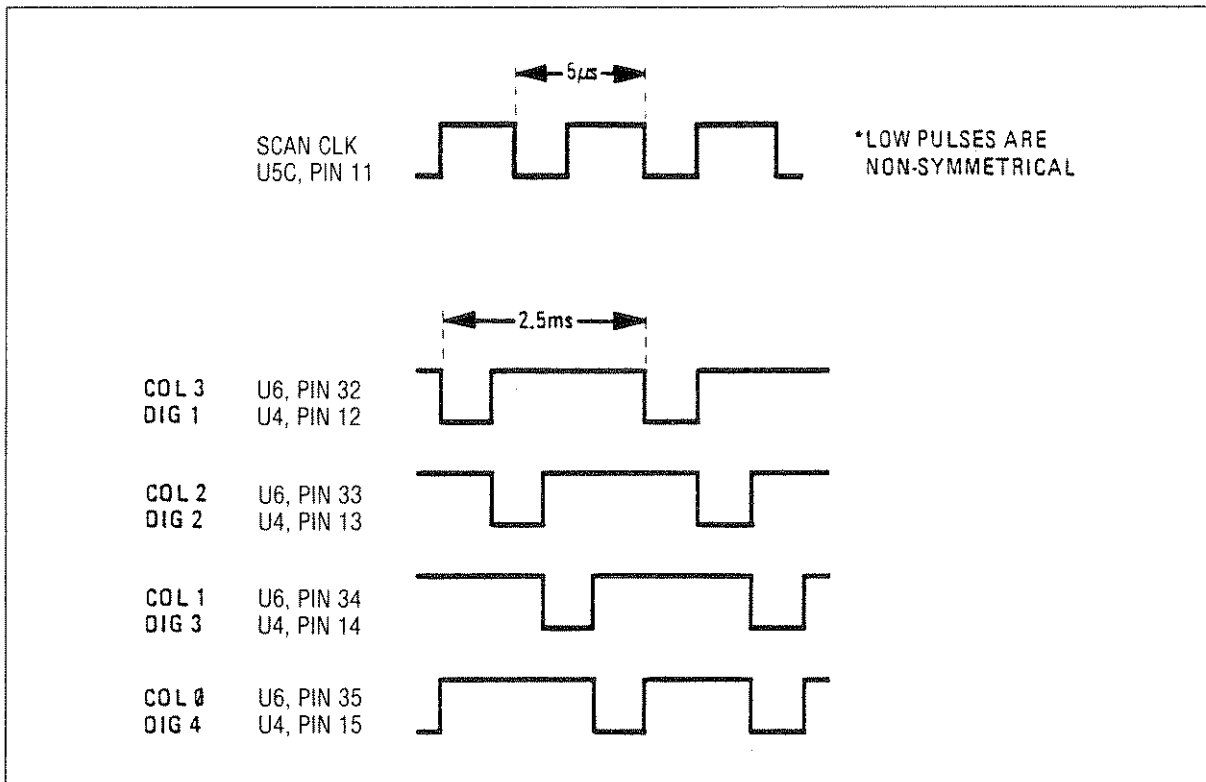

Figure 8-9. Column Strobming

If the patterns are absent, but the 200 kHz clock is present, the problem is probably A1U6. Ensure that problems in A5U5B or the LED display assembly are not pulling the lines low.

If the column strobes are present, probe both the column and row line corresponding to the key in question at A1U6. Observe the traces while pushing the key. The two lines should track each other. If they track, but the microprocessor can't read the codes from A1U6 (and the data bus is good) suspect A1U6.

If a row and column do not track, troubleshoot the keyboard matrix with a continuity checker.

ROTARY KNOB (ROTARY PULSE GENERATOR, RPG)

The RPG converts rotation information into two digital pulse trains which are read by the HP 8350 processor. The components needed to decode these pulse trains are a counter and a device that detects which pulse train leads the other. The lead/lag information allows the processor to know which direction the rotary knob is being turned, while the counter provides rotation speed data. These devices are located on the HP 8350 A2 front panel interface assembly. Some failures which appear to be in the plug-in RPG (like run away output power or RPG inability to change power level) are likely to be caused by a failure in the HP 8350 A2 detection circuitry.

If the plug-in RPG appears to be dead, remove the HP 8350's bottom cover and look at A10J1 pins 34 and 35 with an oscilloscope. Check for the waveforms shown in Figure 8-11, *RPG Pulse Trains*, while slowly turning the RPG. If the signals are present, trace the PIRPGA and PIRPGB lines through the HP 8350 to the A2 assembly. Refer to the HP 8350 A2 service section for further troubleshooting information.

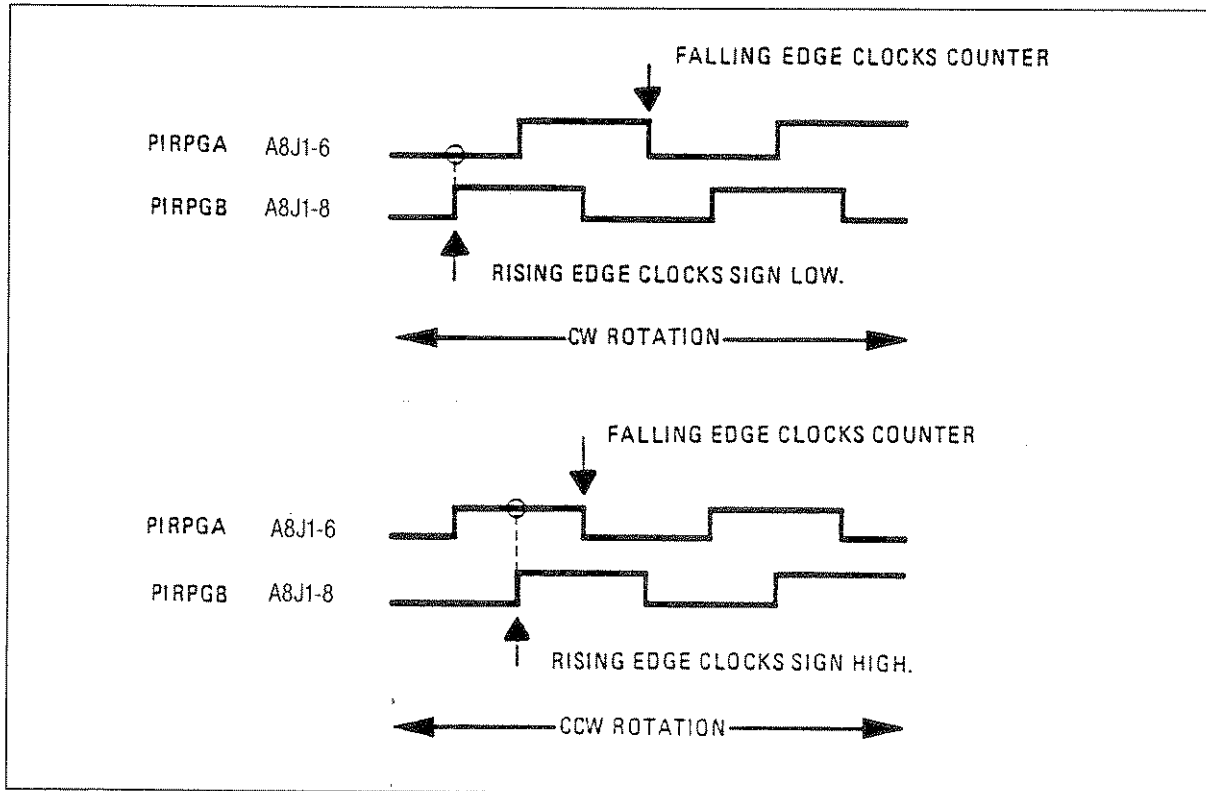

Figure 8-10. *RPG Pulse Trains*

If the signals are absent in the plug-in, check for +5 volts at A8J1, pin 2. Then check for +5V directly at the point where the RPG leads are soldered to the A1 front panel assembly. Turn the RPG and check for the output pulse waveforms right where the RPG output leads are soldered into the A1 assembly. The proper waveforms are shown in Figure 8-10. If either pulse train is not present, make sure the lines are not shorted to ground (desolder the output leads if necessary and check for pulses). If the outputs are not shorted to ground, replace the RPG.

Miscellaneous

The EXT/MTR ALC CAL offset is generated by potentiometer A1R1 with the wiper running between +10 Vdc and -10 Vdc. If the signal is absent, check for the +10V and -10V supplies. If the offset voltage still cannot be produced, replace R1.

FRONT PANEL DISASSEMBLY

When troubleshooting the A1 front panel, it may be necessary to remove the front panel frame assembly to expose the necessary signal points. However, unnecessary handling of this instrument is discouraged. Please note that Table 1-3 lists available extender cables which allow the service technician to operate the plug-in outside the confines of the HP 8350. Many front panel signals can be easily accessed using these troubleshooting aids.

If the need arises, the front panel can be mechanically separated from the plug-in chassis without disturbing any electrical path. Perform the following procedure using Figure 8-11, *Right Side View of Plug-in*.

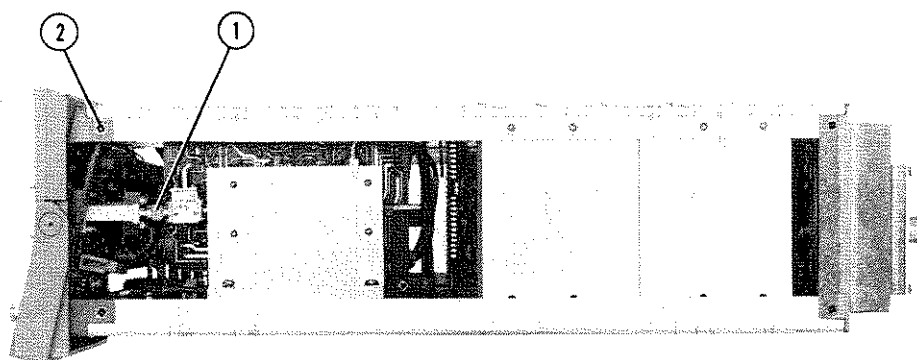

Figure 8-11. Right Side View of Plug-in

PROCEDURE

1. Loosen the 3.5 mm nut at the output of isolator AT1. **Do not remove the isolator from the RF path.**
2. Remove the eight screws securing the front frame to the side struts. The front panel assembly is now free from the chassis. Gently slide the front panel away from the instrument and swing it down to expose the back side of the A1 assembly.
3. To reassemble the front panel, simply reverse the procedure described above.



Be extremely careful when reconnecting the waveguide adapter to the isolator. A misaligned center conductor pin can result in costly damage to the plug-in.

A1 Front Panel Circuit Description

INTRODUCTION

The A1 front panel assembly provides communication between the instrument and the user. Keyboard and rotary knob commands are transmitted to the HP 8350 microprocessor for appropriate action. The numeric power level and plug-in status information is displayed on front panel LEDs. External ALC power calibration is performed by a front panel adjustment and sent to the A4 ALC assembly.

KEYBOARD

Push Button Switch Matrix, Block F Keyboard/Display Interface, Block A

The push button keyboard is arranged in a column/row matrix. The column lines are sequentially strobed, while the row lines are sensed to determine when a key is depressed. The matrix scanning and sensing, along with the debouncing functions, are performed by A1U6, the keyboard/display interface. A1U6 is capable of monitoring the microprocessor. When a key is depressed, A1U6 eliminates contact bounce, encodes and stores the column/row information in an internal register, and sets the FLAG line. When the microprocessor detects the flag, the keyboard codes are read from A1U6 and processed.

DISPLAY

Power Display, Block D Keyboard/Display Interface, Block A Power Display Driver, Block C

The numeric power display is a four digit, seven segment LED array. Only one digit is enabled at a time by the DIGn lines. These lines are continuously scanned by the buffered keyboard column lines from A1U6, providing a flicker free display. The seven segment and decimal point information corresponding to the enabled digit is provided by buffered lines from A1U6. When the display is updated, data is sequentially written into A1U6 from the microprocessor and stored internally. A1U6 is then responsible for scanning the display without requiring constant attention from the HP 8350.

LED Annunciator Latch, Block B LED Annunciators, Block E

Octal latches A1U8 and A1U9 control the various front panel and push button LED annunciators. When clocked by the FP3 or FP4 line from the A3 digital interface assembly, the latches store a byte of data from the data bus, and light the LEDs determined by the bit pattern (low=ON)

ROTARY KNOB (Rotary Pulse Generator, RPG)

RPG (Rotary Pulse Generator), Block H

The rotary knob, also referred to as the rotary pulse generator (RPG), provides control as selected by the keys below it (power sweep, power level, and slope). The RPG, when turned, sends digital pulses to the HP 8350's microprocessor. The two pulse output lines go directly to the HP 8350's A2 front panel assembly via the HP 8350 and 83570A motherboards.

External Leveled Power Calibration Control, Block G

Cal adjustment introduces an offset to the leveling loop to match absolute RF power output to external leveling devices.

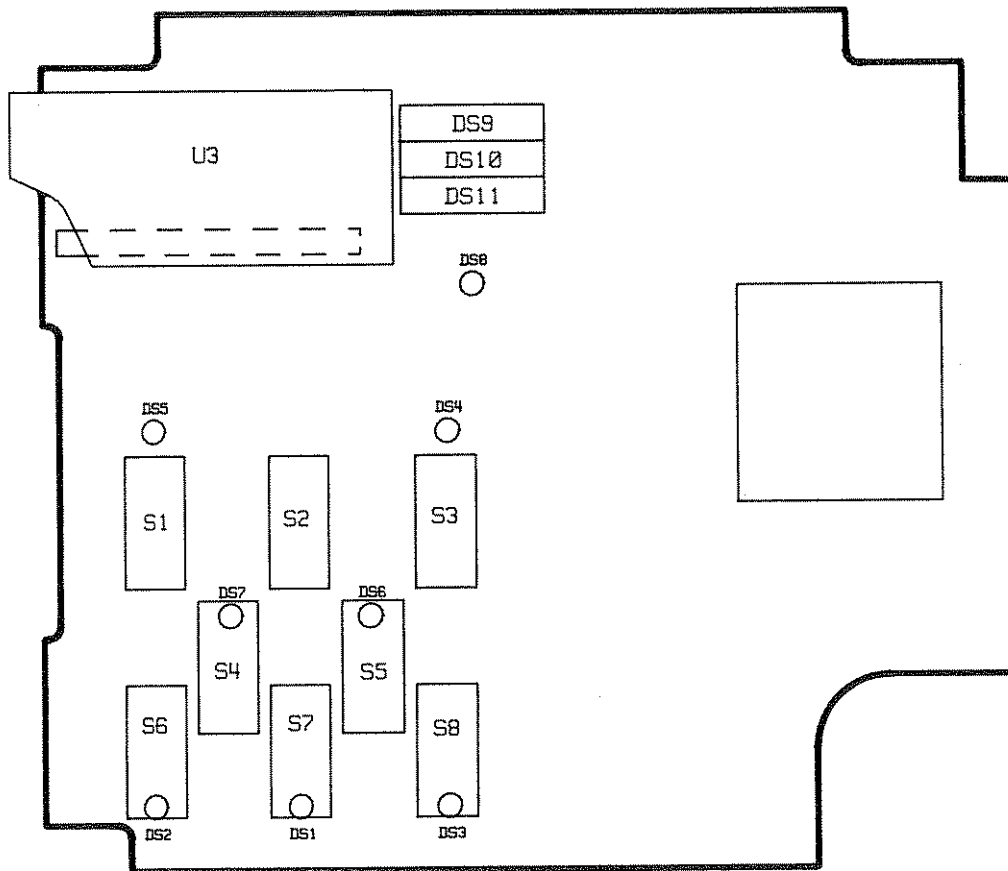

Figure 8-12a. A1 Front Panel Component Locations

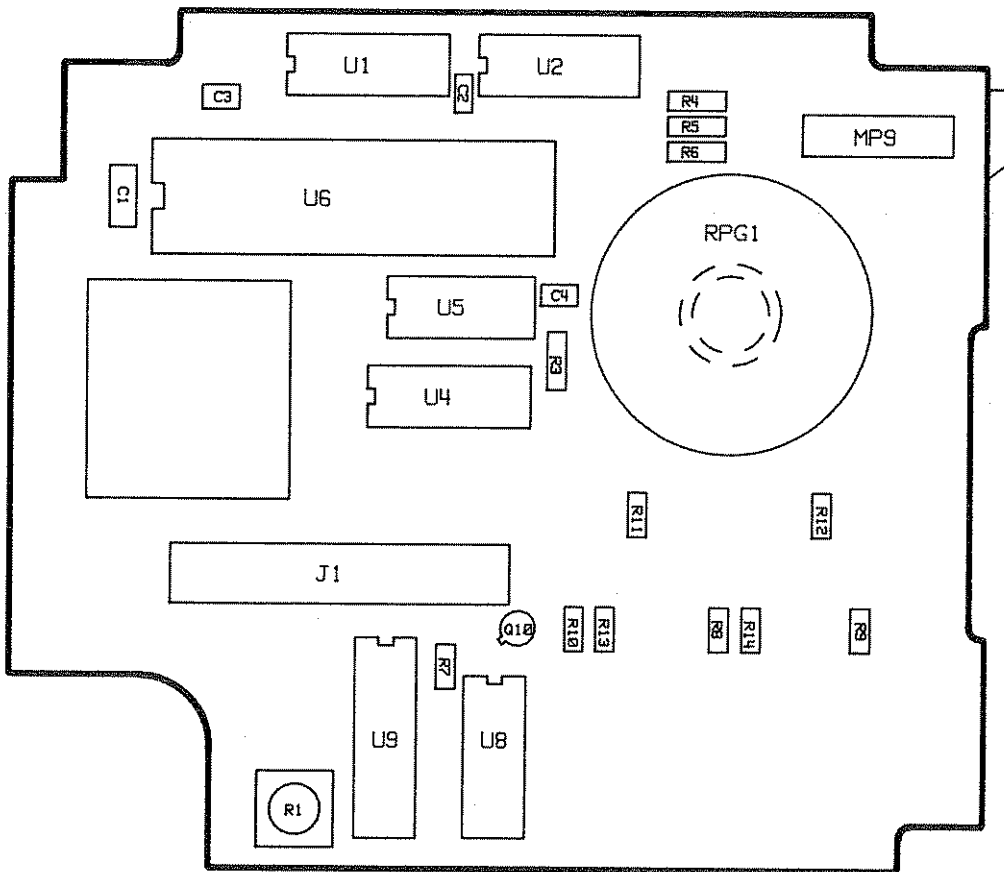
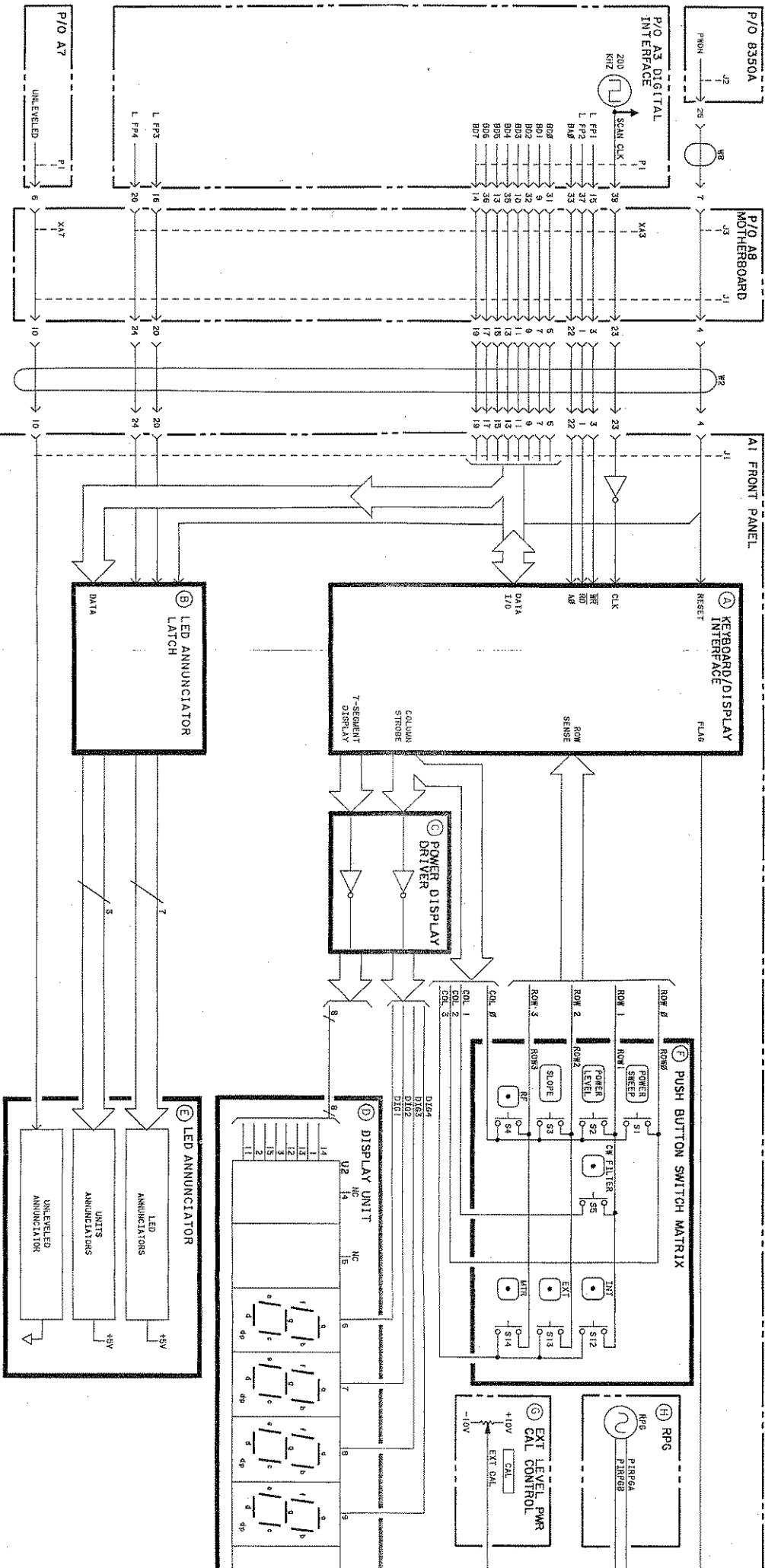

Figure 8-12b. A1 Front Panel Component Locations



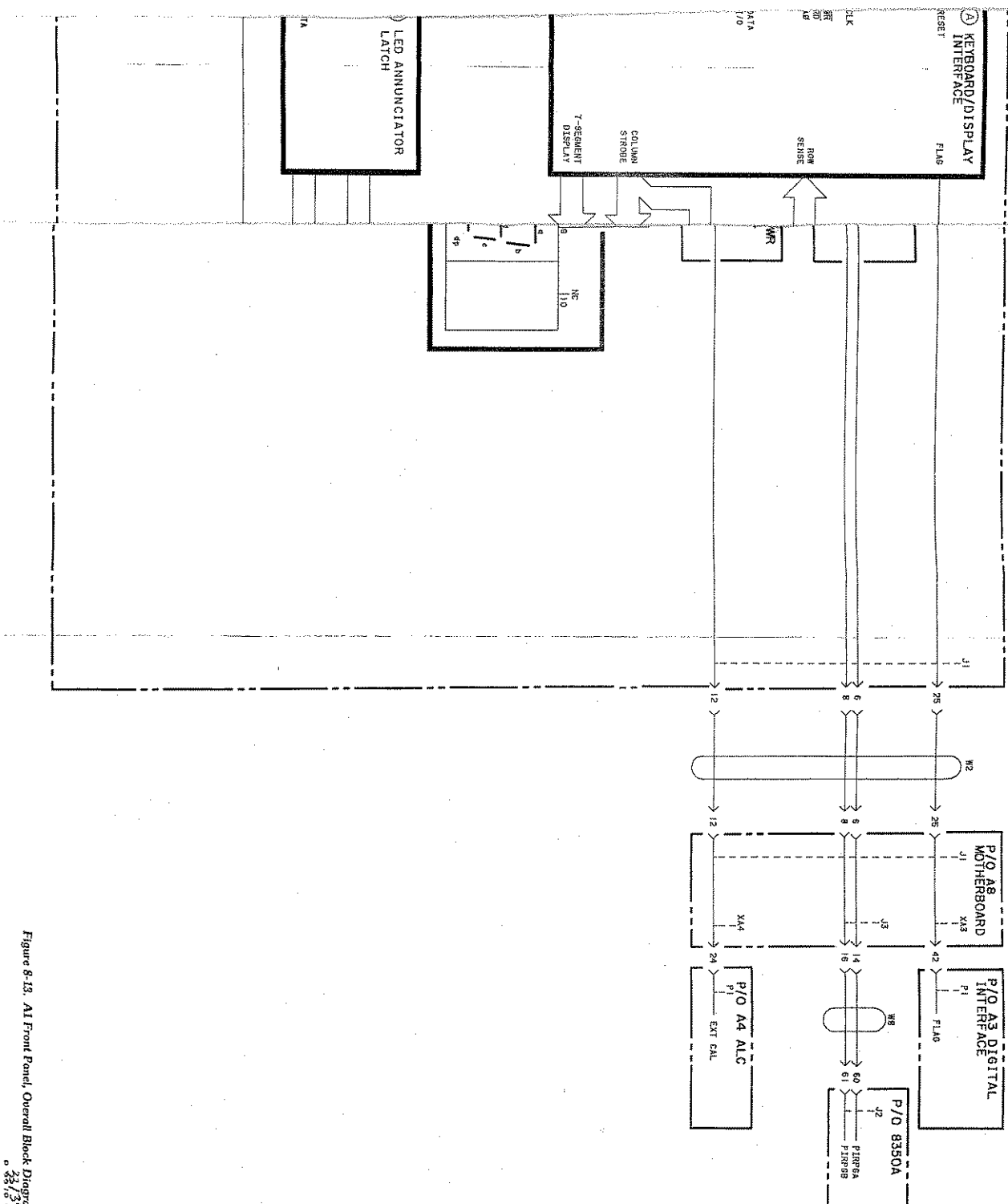
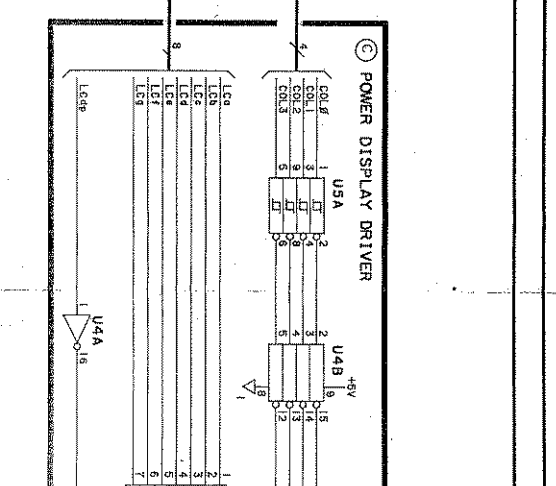
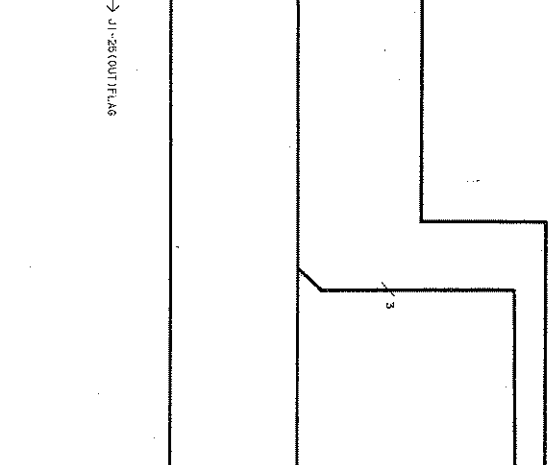
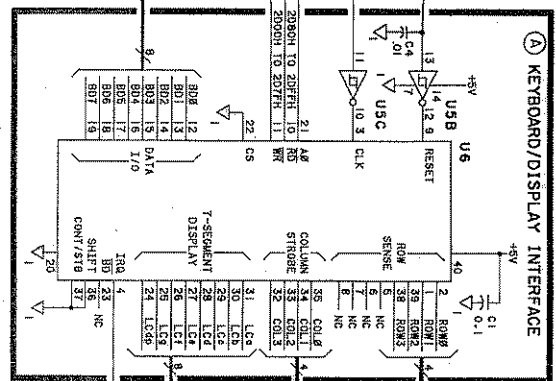
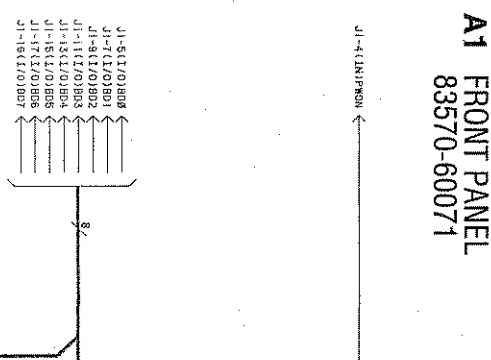

Figure 8-13. AI Front Panel, Overall Block Diagram

A1 FRONT PANEL 83570-60071



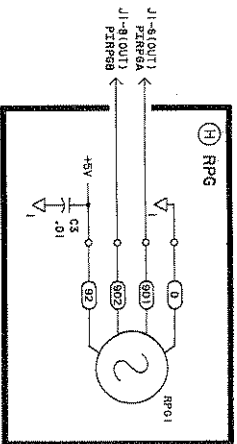
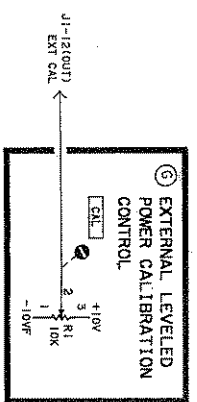
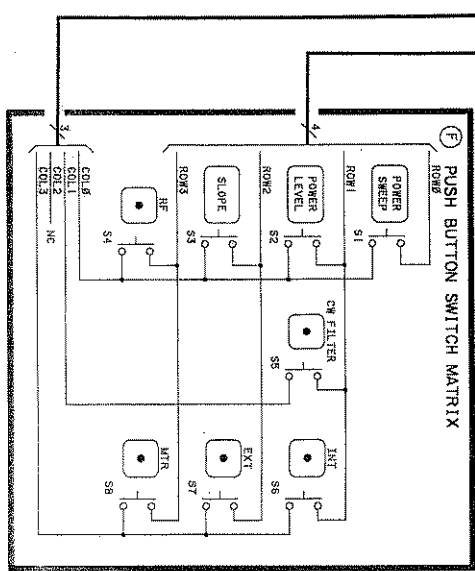
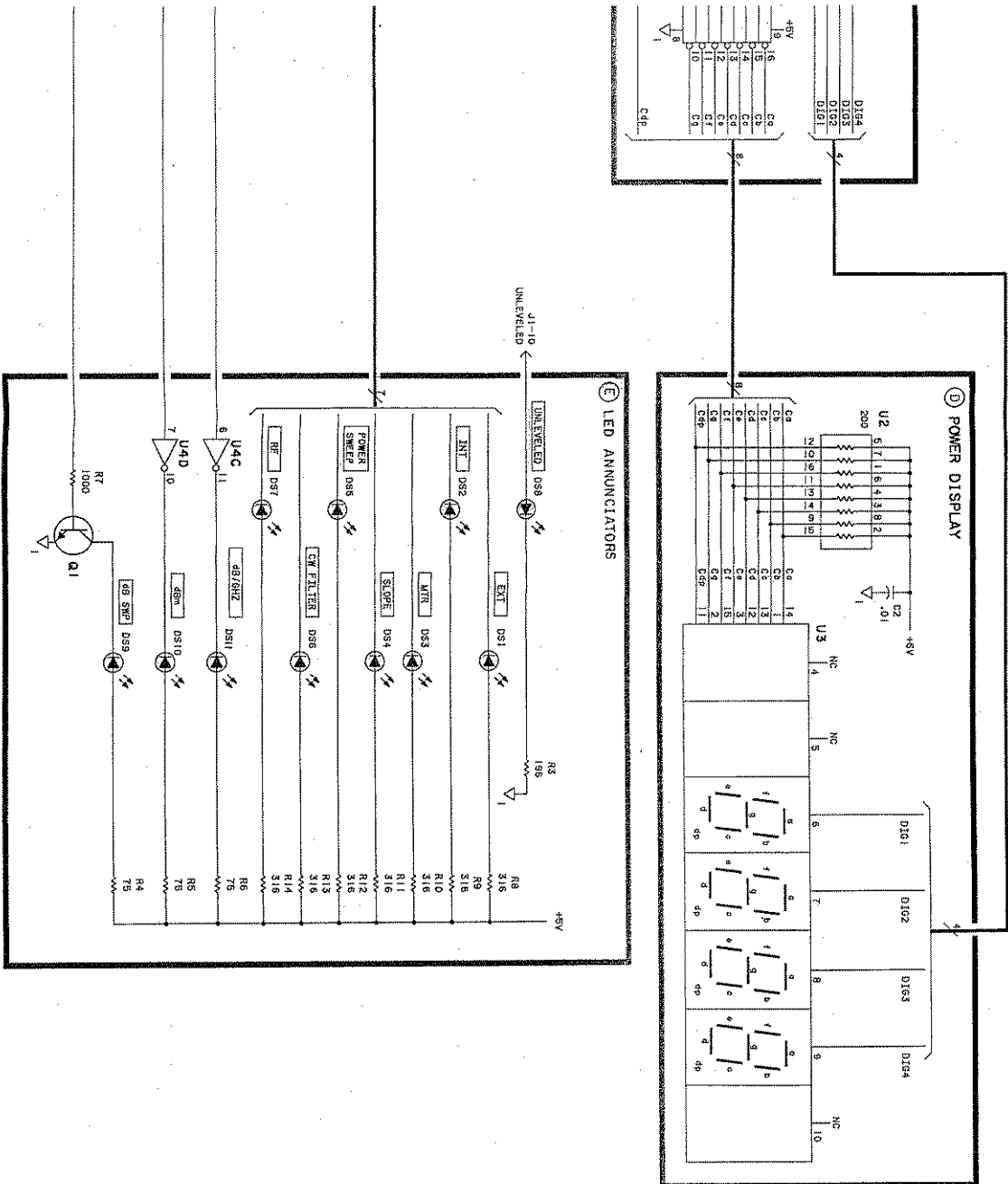

Figure 8-14. AI Front Panel, Schx

A2 Doubler Circuit Troubleshooting

INTRODUCTION

NOTE: The mod driver circuit is located on the A2A1 pulse assembly, attached directly to the A2 doubler microcircuit. The internal RF modulator is inside the A2 microcircuit and cannot be replaced separately. The A2 microcircuit and A2A1 pulse assembly are not separately replaceable.



The A2 microcircuit is highly susceptible to damage from electrostatic discharge. Handle these components only when wearing a grounded wrist strap. Never place internal components on a work surface that is covered with indoor/outdoor carpet! The only recommended surface on which a microcircuit may be placed is a grounded anti-static mat.

The RF modulator in this plug-in is a negative bias shunt-type diode. Refer to Figure 8-15, *Simplified Modulator Schematic*. The mod driver provides the voltage-to-current conversion and current gain needed to drive the modulator. As the mod driver voltage at A4TP5 increases, the current drawn from the modulator by A2A1Q3 also increases, shunting more RF energy to ground and allowing less to pass through.

To establish a fixed voltage level for troubleshooting, A4TP5 can be forced high (+8.9 Vdc) or low (-1.2 Vdc). Ground TP11 on the A4 assembly. On the HP 83570A, select EXT ALC, and enter an RF power level of -1 dBm. Turn the EXT/MTR ALC CAL screw fully clockwise, verify a signal level of approximately +8.9 Vdc at A4TP5 and -0.9 Vdc at A2A1TP5. (The front panel UNLEVELED LED should not go on.) Turn the CAL control fully counter-clockwise and check for -1.2 Vdc at A2A1TP5. (In this case, the UNLEVELED lamp should light.)

During normal operation, A4TP5 should be approximately +0.7 Vdc, while A2A1TP5 should be close to -0.6 Vdc.

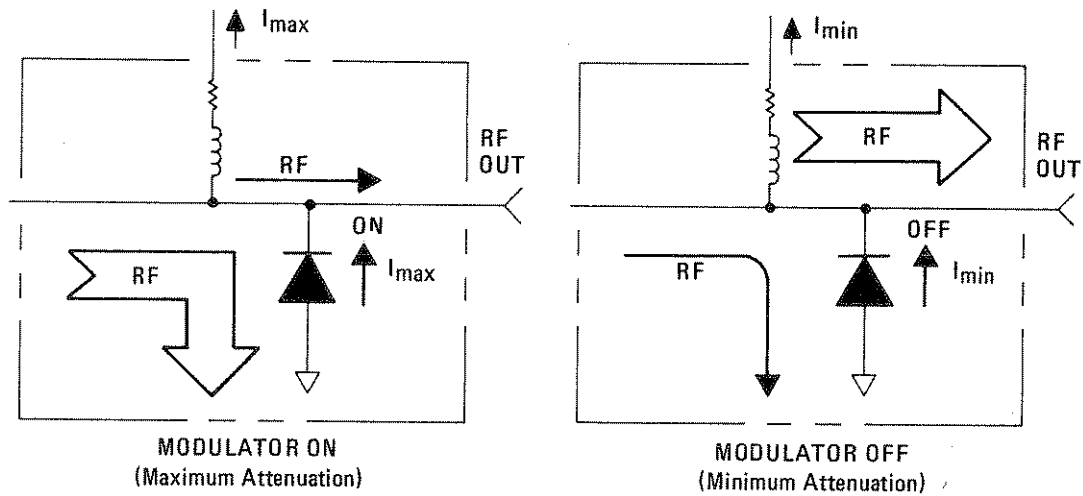

Figure 8-15. Simplified Modulator Schematic

Table 8-7, *Modulator Bias Levels*, provides the approximate bias levels for a properly functioning modulator assembly.

Table 8-7. Modulator Bias Levels

A4TP5	A2A1TP5
+8.9V +0.7V -1.2V	-0.9V (Minimum RF) -0.6V (Leveled Operation) +9.5V (Maximum RF)

NO RF POWER

NOTE: Turn off line power before removing or installing any assembly.

If the symptom is low or no RF power, turn RF power to off and check the voltage at A7TP6 to ensure there is 0 VDC \pm 100 mV present. If it isn't, refer to A7 troubleshooting. If the voltage is correct, check A2TP8 and ensure the voltage reading is \leq 100 mV. If the voltage reading is incorrect, suspect the A2 doubler assembly.

If the symptom is no RF power, remove the A4 ALC assembly. This will remove bias from the driver, turn A2A1Q3 (Block G) off, and allow full RF power to pass through the modulator. If full unlevelled RF power is obtained, suspect the RF detector or A4 assembly. Check the A4TP5 voltages listed in Table 8-7 and the detector output voltage listed in Table 8-11 (A4 ALC TROUBLESHOOTING).

If there is no RF power with A4 removed, reinstall the A4 assembly. Force A4TP5 alternately high and low as described above, and check the voltage at A2A1TP5 against the values given in Table 8-7.

- If A2A1TP5 stays near 0 Vdc, the modulator diode is probably shorted. However, before replacing any microcircuit, always check the power level directly into and out of the assembly to ensure that the problem is isolated to that particular assembly.
- Force A4TP5 low (-1.2 Vdc) as described above. This should turn A2A1Q3 off allowing both A2A1TP5 and the collector of A2A1Q3 to float to approximately $+9.5$ Vdc. If A2A1TP5 stays near 0 Vdc, the modulator is probably shorted.

If A2A1Q3 and the modulator are functioning properly, but RF power is still missing or low, check the following RF levels with a power meter or spectrum analyzer. When checking power levels internal to the RF signal path, ensure that all critical ports are terminated in 50 Ohms.

- If power is minimal, check the RF level directly out of the A9 YO. The minimum level from this assembly should measure $+13$ dBm.
- Check the RF levels around A2 doubler with no modulation (i.e. remove the A4 assembly). Unleveled power from the A2A2 microcircuit should reach about $+11$ dBm.

FULL UNLEVELED RF POWER

If maximum unleveled RF power is observed, attempt to achieve minimum RF power out by forcing A4TP5 to $+8.9$ Vdc as described above. A2A1TP5 should read approximately -0.9 Vdc.

- If the voltage at A2A1TP5 is approximately -0.9 Vdc, the modulator diode is probably open. However, be sure to check for open contacts between the A2A1 pulse assembly and A2 microcircuit before replacing the two assemblies (they are not separately replaceable).
- If A2A1TP5 reads 0 Vdc, the modulator diode is probably shorted.
- If A2A1TP5 reads about $+9.5$ Vdc, A2A1Q3 is probably open.

1

2

3

A2 Doubler Circuit Description

INTRODUCTION

The A2 assembly consists of the A2A1 pulse assembly, A2A2 microcircuit/heatsink, and A2AT1 isolator.

A2A2 DOUBLER MICROCIRCUIT

This assembly transforms the 9 to 13.25 GHz YIG oscillator (YO) output into the 18 to 26.5 GHz RF signal which is available at the front panel waveguide connector.

Figure 8-16, *A2 Doubler Microcircuit Simplified Block Diagram*, is shown below. This functional group includes an input coupler, diode modulator, output coupler/detector, and four FET stages; preamp, doubler, and two post-doubler amplifiers.

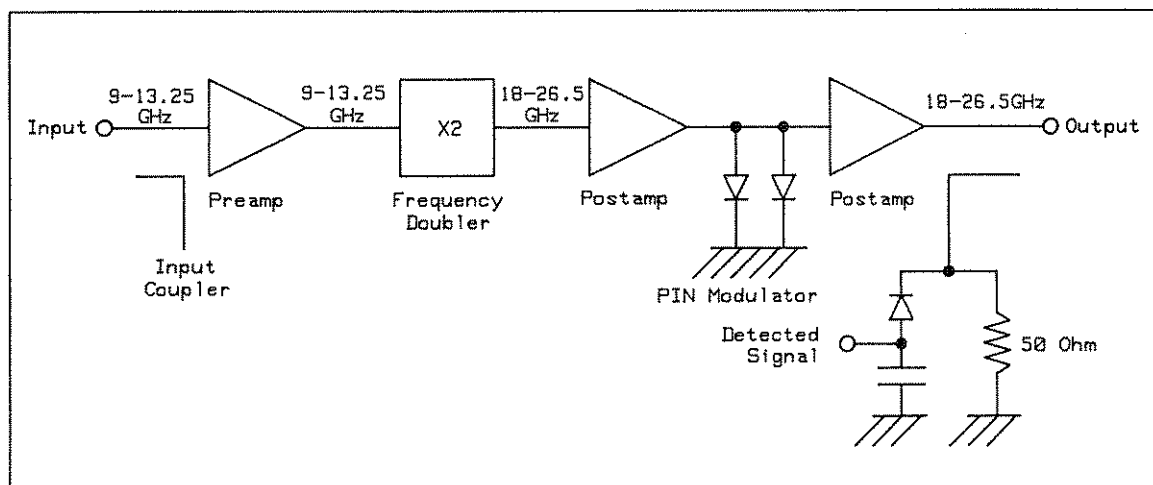

Figure 8-16. *A2 Doubler Microcircuit Simplified Block Diagram*

The input coupler pipes the raw YO output (9 to 13.25 GHz) to the rear panel AUX OUT connector (J4) allowing the use of P-band frequency counters.

The doubler circuit generates the 18 to 26.5 GHz signal. A low-pass filter eliminates out-of-band harmonics from the doubled fundamental.

A PIN diode modulator adjusts the amplitude of the RF signal in accordance with the DC signal generated by the internal coupler/detector (or external leveling device).

A2AT1 ISOLATOR

The isolator prevents frequency pulling and undesirable mixing products caused by external mismatches, and improves the source match of the plug-in.

W1 provides a transition from coaxial to waveguide and acts as a high-pass filter, eliminating the YO fundamental frequency.

A2A1 PULSE ASSEMBLY

The pulse assembly performs three basic functions:

1. Supplies the microcircuit with the proper bias voltages, shaped for optimum performance.
2. Pulses the RF signal for various modulation modes.
3. Supplies current to the modulator diodes for leveling the RF output.

Bias Shaping

Most of the circuit blocks in this assembly shape the DC bias for each microcircuit device. Shaping is provided by four adjustable potentiometers and an array of 13 factory resistors. These resistors are not field selectable and should not be substituted.

Bias levels on the doubler FETs and the two post-doubler stages follow the tuning voltage (VTUNE) to enable variations in operating points over the plug-in frequency range.

Pulse Modulation

Modulation of the RF signal is accomplished by switching the drain bias signal to the last stages. The pulse amplifier (Block C) accepts the rear panel PULSE IN signal through W4 to the SMB connector at A2A1J1. An input signal of +1 Vdc will initiate some RF attenuation; +3 Vdc will completely shut off the RF output.

In addition, the PULSE I/O line tells the pulse amplifier (Block C) that an HP 8350 marker is enabled, squarewave modulation is selected, or that the HP 83570A front panel RF ON/OFF key has been disengaged. All these inputs act upon the drain bias of the last stage.

Amplitude modulation (AM) is a function of the ALC loop and is discussed in the A4 ALC service section.

Modulator Drive

The MOD DRIVE signal from the A4 ALC assembly ranges from -1.2 Vdc (modulator off) to $+8.5$ Vdc (modulator on). This circuit converts the voltage output of the main ALC amplifier (A4 assembly) to a current drive for the modulator diodes. Troubleshooting hints for this circuit are provided in the A4 ALC service section.

Table 8-8. Connector Pin Descriptions

A2A1J3					A8J9
PIN	SIGNAL	I/O	TO/FROM	A2A1 BLOCK	PIN
1	+10V MOD DRIVE	IN	P1-8 A4P1-22	J	5,17 7
2		IN		G	
3					
4					
5					
6					
7					
8					
9	+15V L RFON	IN	P2-29 A7P1-21	J	19 3
10		IN		B,H	
11	INT DET -10V	OUT	A4P1-20 P1-13	A2	11 4,16
12		IN		J	
13	-VTUNE PULSE I/O	IN	A7P1-40 A7P1-24	A,B,D,E	14 6
14		I/O		C	
15	+VTUNE +8.0V REF	IN	A7P1-42 A7P1-18	D,E	13 2
16		IN		A,B,D,E,F	
17	-15V INT DET RET	IN	P2-28 Chassis Ground	J	20 12
18					

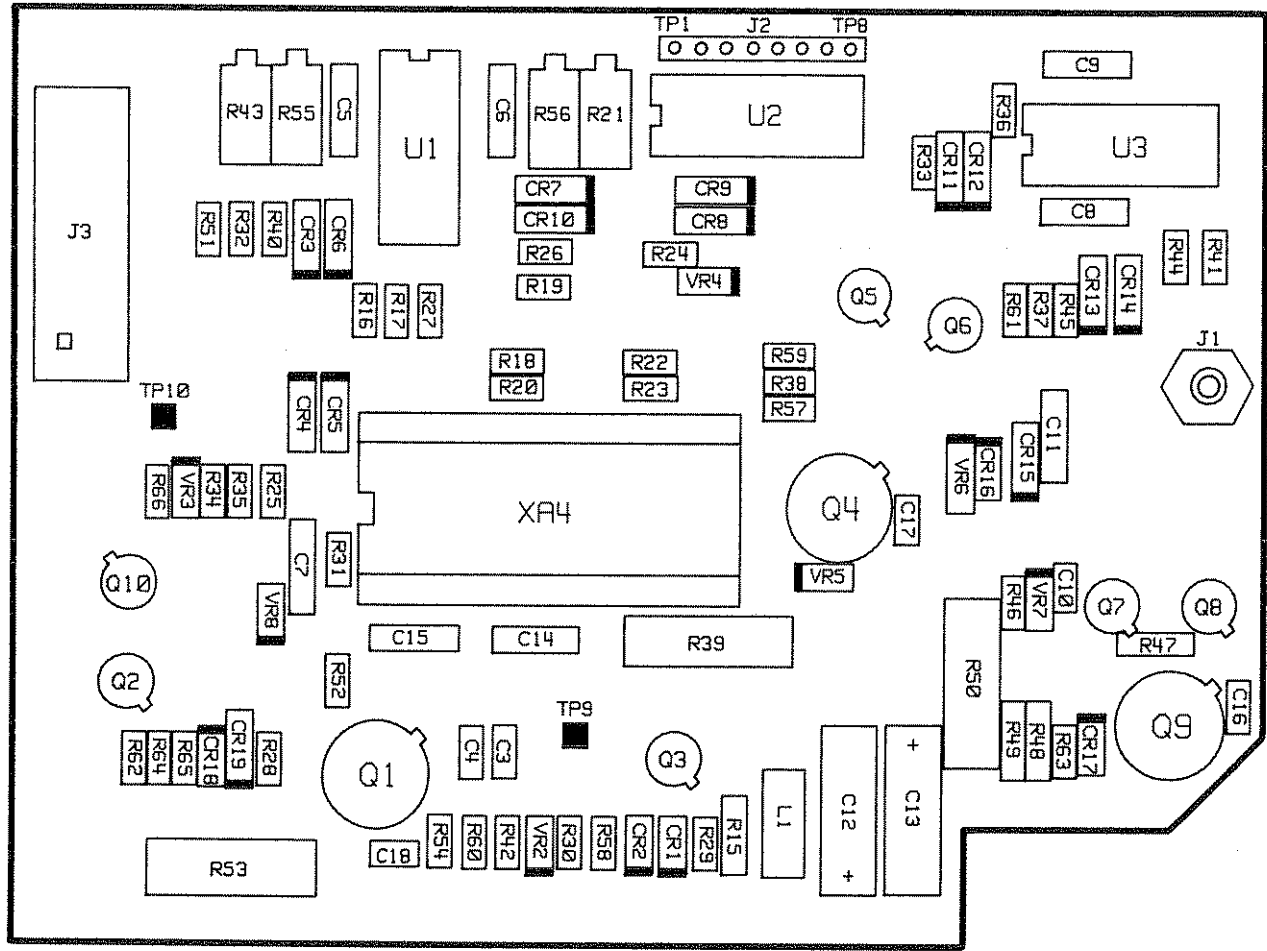
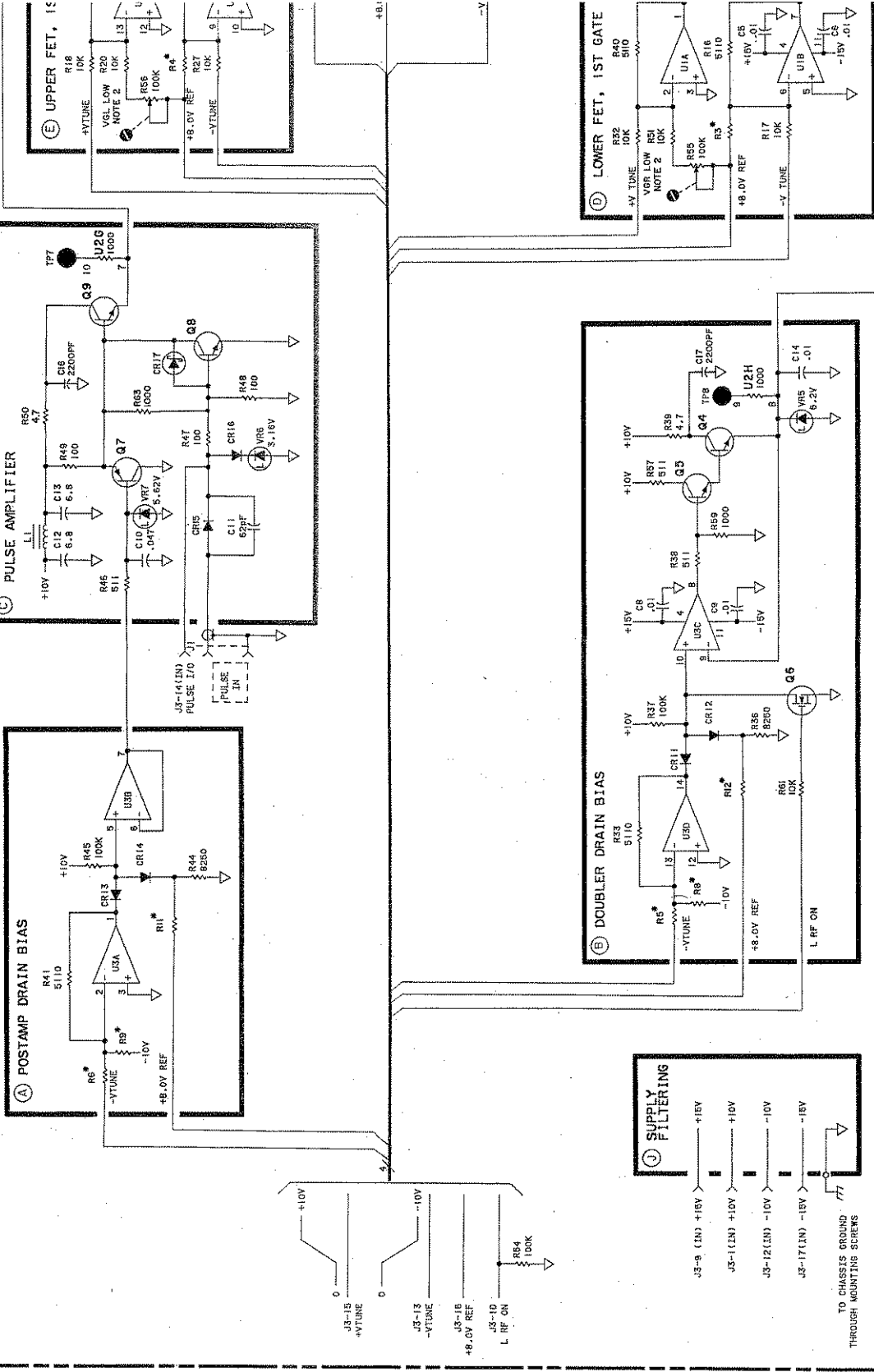

Figure 8-17. A2A1 Pulse Board Assembly Component Locations

A2 DOUBLER ASSEMBLY 5086-7306

A2A1 PULSE BOARD



SERIAL PREFIX: 2520A

A2A2 DOUBLER, MODULATOR, COUPLER

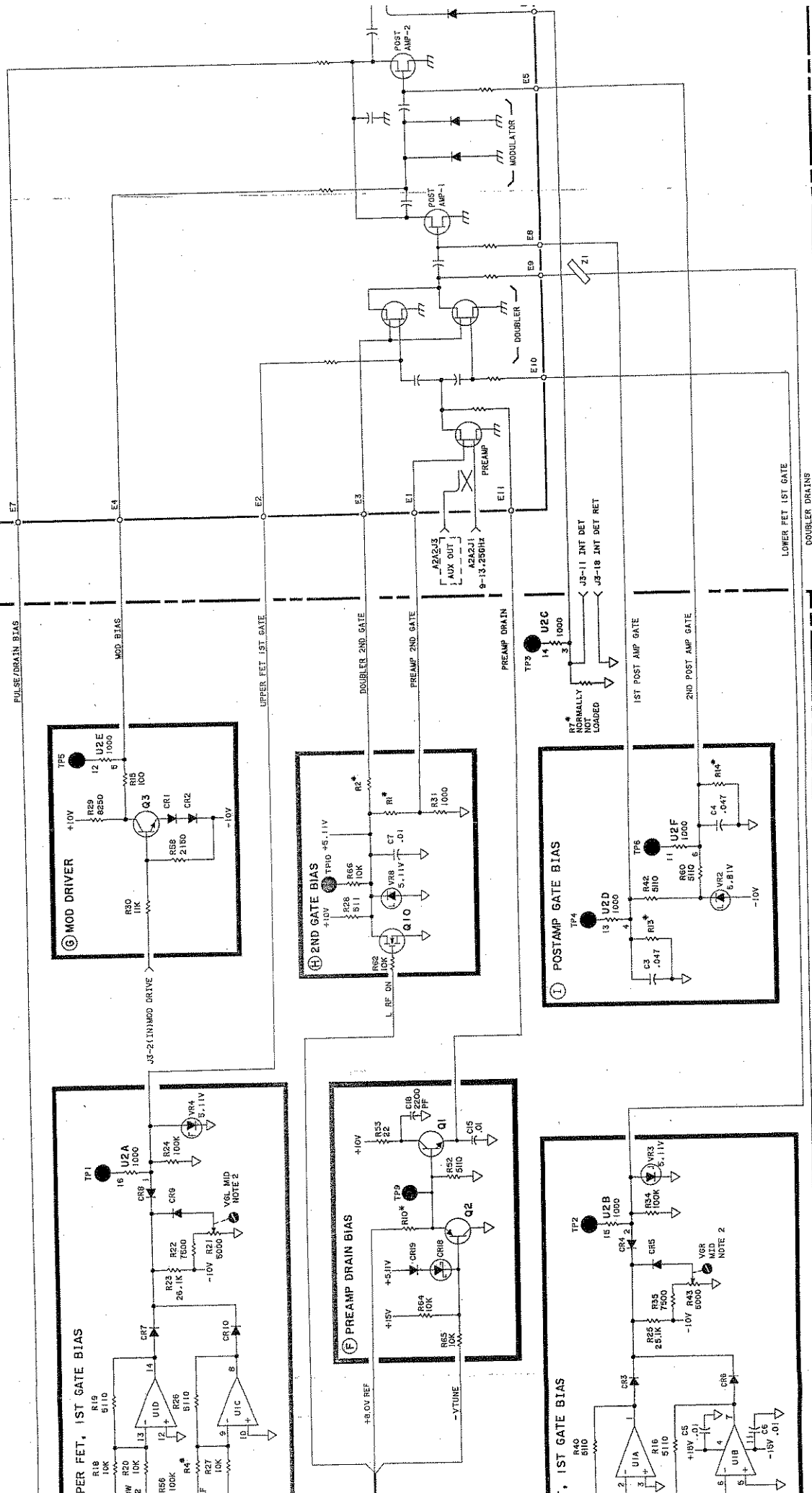

(A) UPPER FET, 1ST GATE BIAS

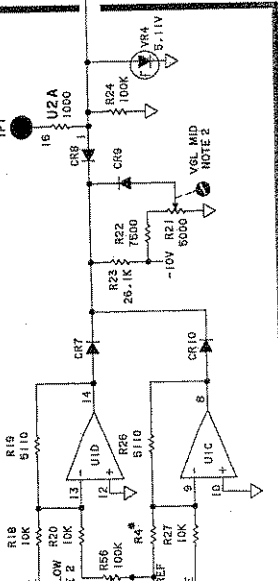

(B) PREAMP DRAIN BIAS

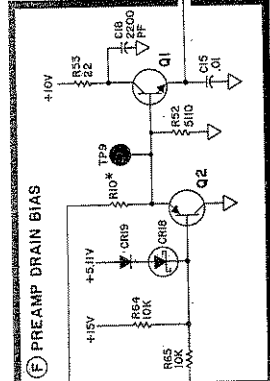

(C) 2ND GATE BIAS

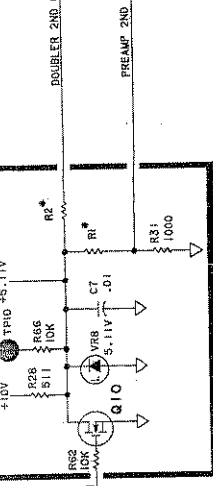

(D) 1ST GATE BIAS

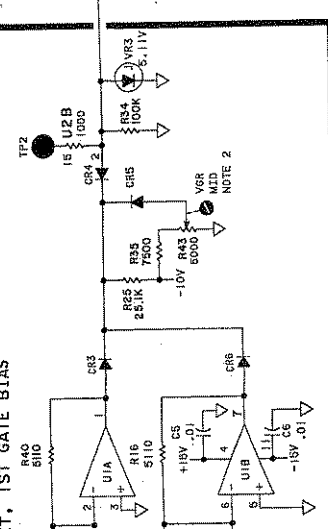

(E) POST AMP GATE BIAS

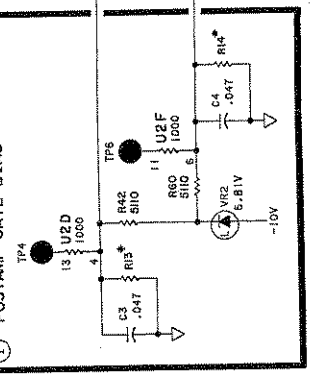

(G) MOD DRIVER

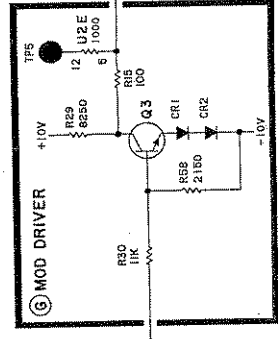

(H) 2ND POST AMP GATE BIAS

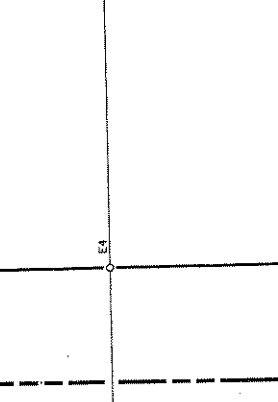

UPPER FET 1ST GATE

DOUBLER 2ND GATE

PREAMP 2ND GATE

PREAMP DRAIN

1ST POST AMP GATE

2ND POST AMP GATE

LOWER FET 1ST GATE

DOUBLER DRAINS

DOUBLER DRAINS

DOUBLER DRAINS

TOR, COUPLER

CAUTIONS

AVOID UNNECESSARY HANDLING OF THE A2A2 DOUBLER MICROCIRCUIT. THIS ASSEMBLY MAY BE DAMAGED BY STATIC DISCHARGE.

NOTE

1. RESISTORS MARKED WITH AN * ASTERISK ARE FACTORY SELECTED AND MOUNTED ON A PLUG-IN HEADER ASSEMBLY.
2. VARIABLE RESISTORS ARE ADJUSTED AT THE FACTORY.

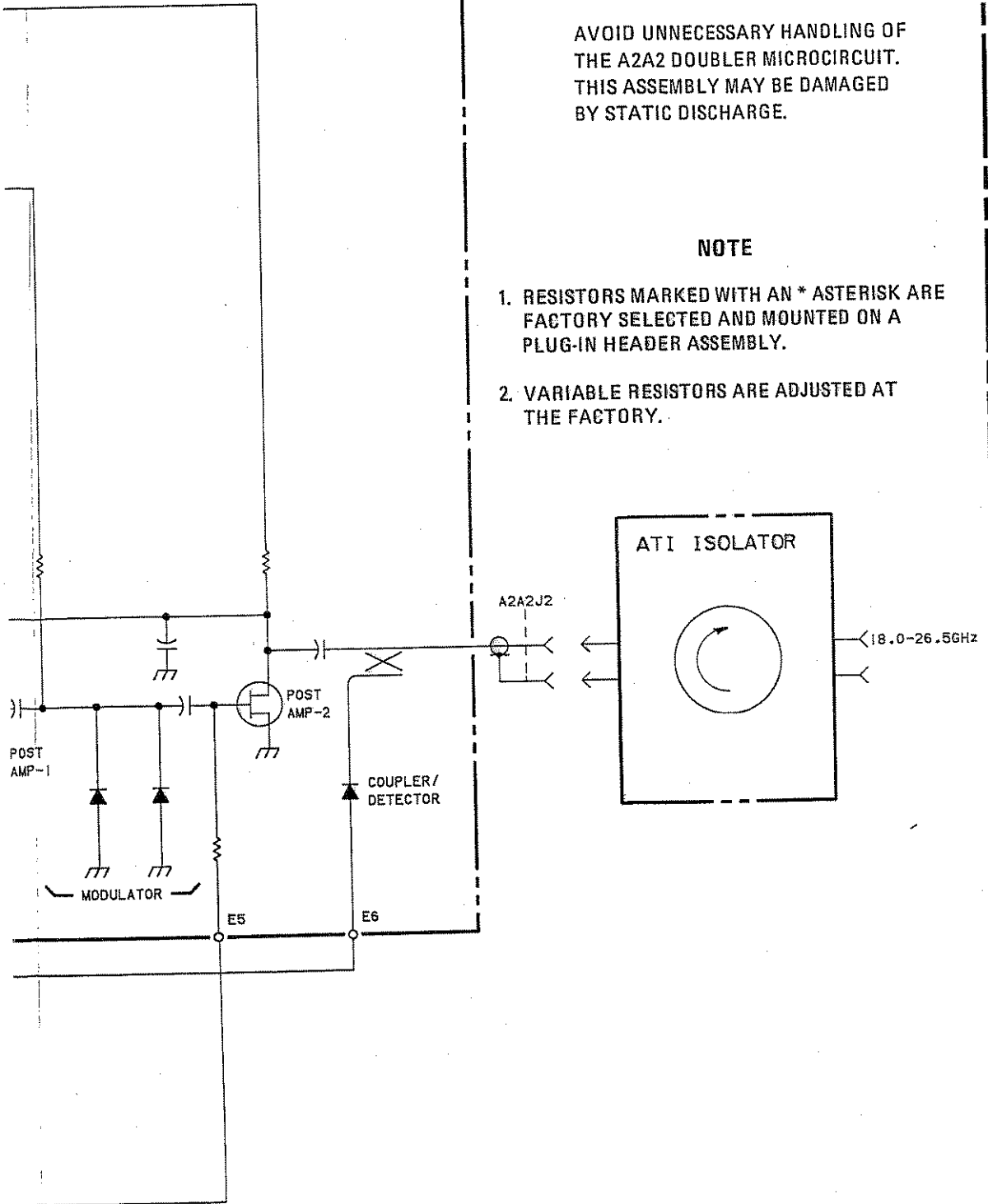

Figure 8-18. A2 Doubler, Schematic Diagram

A3 Digital Interface Troubleshooting

The A3 digital interface assembly is the principle exchange for digital data, address, and timing signals used throughout the RF plug-in. The read only memory (ROM) ICs on the A3 assembly contain firmware and constants used for plug-in interrupt routines. Major enable lines used on the front panel and throughout the plug-in are decoded on this assembly. Note that some digital control lines (stop sweep request, LSSRQ, and rotary knob "RPG" lines) do not pass through the digital interface assembly.

A failure in the A3 digital interface typically disables the entire RF plug-in, and causes large errors in frequency, amplitude, and control. The front panel displays will probably be inoperative, and front panel controls (except the RPG) will not produce any effect.

The HP 8350 sweep oscillator may or may not be disabled by a plug-in failure. A simple test to determine whether the HP 8350 is at fault is to remove the plug-in and press the sweep oscillator's **[INSTR PRESET]** key. If E001 is displayed, the HP 8350 is probably working properly, but the instrument bus connections to the RF plug-in are not checked out when this test is performed. A different error code, especially E005, indicates problems in the HP 8350.

Visually inspect the plug-in for damage, frayed cables, and loose connectors. Check ribbon cable W8 between the plug-in interface and A3 assembly. Check the ribbon cable in the HP 8350 leading from its motherboard to the plug-in interface.

Check the +5VB line at A3J1 pins 35, 36, or 38, to make sure power is being supplied to the plug-in. The A3 assembly supplies +5V to the rest of the plug-in; check A3P1 pins 6 and 7 for +5Vdc.

Check configuration switch A3S1 and make sure that it is set for the plug-in model and user selected configurations as described in Section III, Operation.

The A3 digital interface assembly is made accessible for service with the following procedure:

1. Remove the RF plug-in from the HP 8350.
2. Disconnect W8P1 from A3J1, and remove the A3 assembly from the plug-in.
3. Replace the plug-in in the HP 8350.
4. Remove the top cover of the HP 8350.
5. Insert a 44 pin extender board into A8XA3.
6. Install the A3 assembly on the extender board and reconnect W8P1.

PLUG-IN SELF TEST

Major portions of the A3 digital interface assembly and the instrument bus connecting it to the HP 8350 are tested by the self test routine performed at instrument preset and power-on.

The plug-in ROMs are tested by reading a test pattern out of the ROMs, then performing a "checksum" on the contents of the ROM ICs. If the test passes, proper operation of the data bus, address bus, and major timing signals is assured. This test also verifies the operation of the ROMs themselves, as well as ROM address decoding circuitry. If the test fails, error code E001 appears, indicating a fault in these components or in the instrument bus.

The LIRD, FLAG, and PIIRQ lines are not tested by the routine, nor are the internal data (BD0 — BD7) and address (BA0 — BA3) busses.

Other error codes (from E050 to E099) indicate specific problems in the plug-in. These can occur either at instrument preset, power-on, or during the course of normal operation, and are discussed in greater detail below.

An error code indicates a failure in specific components. If self test passes, these components are most likely working properly. Hence, the troubleshooting information below is broken into the following sections:

- Error Code E001 "Plug-in Failure"
- Error Code E052
- Error Code E053
- No Error Code Displayed

Refer to the appropriate section indicated by the self test results.

Error Code E001

Error code E001 indicates a failure in one or more of the following areas:

- Connections between the HP 8350/plug-in interface and instrument bus.
- HP 8350/plug-in interface
- Connections between HP 8350/plug-in interface and A3 assembly
- Plug-in buffers
- ROM address decoding
- ROM(s)

The instrument bus internal to the HP 8350 is checked during self test and will produce Error E005 on failure. However, branches from the instrument bus leading to the plug-in are not tested.

In the HP 8350, check cables between the motherboard and the HP 8350 chassis connectors J2 and J3 leading to the plug-in for damage or loose connections. Likewise, in the plug-in, check the cabling between chassis P1 and P2 and the A8 motherboard or A3 digital interface. Next, check the individual pins and sockets of the HP 8350/plug-in interface connectors for bent or missing pins. Make sure that the A3 assembly is firmly seated into its motherboard socket, and that ribbon cable connections are making good contact.

Hexadecimal Data Read

Perform a hex data read by entering:

<p>[SHIFT] [0] [0] [4] [0] [0] [0] [M3]</p>	<p>Direct Component Address mode Address location 4000 Performs Hex Data Read</p>
---	---

The HP 8350 **FREQUENCY/TIME** display should indicate 55. Increment the address to 4001 by pressing the up arrow key, the **FREQUENCY/TIME** display should indicate AA. If these numbers are read, the data lines and the 4000H ROM enable line are functional. If these tests do not execute, run hex data rotation write function below :

Hexadecimal Data Rotation Write

Perform a hexadecimal data rotation write by entering:

[SHIFT] [0] [0] [4] [0] [0] [0] [M4]

Check the 4000H line to U1 for activity, and troubleshoot the address decoding circuitry if there is none. Repeat the above key sequence substituting address location [5] [0] [0] [0]. Check the 5000H line to A3U2 for activity.

The address lines can be checked by using the hex data write feature. Alternate ones and zeros are sent on the address lines when writing to address location 5555H or 2AAAH. By performing a hex data write to each address location, all thirteen address lines are pulsed high and low. On the HP 8350, enter:

[SHIFT] [0] [0] [5] [5] [5] [5] [M4]

Check that all even address lines (A0, A2,...A12) are pulsed high, and all odd address lines (A1, A3,...A11) are pulsed low. On the HP 8350, enter:

[SHIFT] [0] [0] [2] [A] [A] [A] [M4]

Check that all odd address lines are pulsed high and all even address lines are pulsed low.

Error Code E052

Error code E052 indicates a probable failure in the 200 kHz clock.

First check the 200 kHz clock. It is not necessary to place the A3 assembly on an extender board. The SCAN CLK line is accessible at A3U3 pin 3, at the top of the A3 assembly. The output frequency should be approximately 200 kHz. The pulse train is not symmetrical, and has TTL levels. If no clock signal is found, suspect A3U3 (Block D).

Error Code E053

E053 generally indicates a failure in the PIA (Peripheral Interface Adapter), A3U4 (Block E). However, the problem might be in the the output stages of A3U5. Enter **[SHIFT] [5] [5]**, and check CTR 0 and CTR 1 waveforms as shown in Figure 8-19. If they are correct, A3U5 is functional. Next, check the LPIAE line as shown in Figure 8-19, and make sure the L WRITE line shows activity. If not, troubleshoot the appropriate address decoding circuitry or buffer. Then, check L PIIRQ for the squarewave shown in Figure 8-19. If it is inactive, replace A3U4.

NO ERROR CODE

If no error code occurs and the HP 8350 displays the correct start and stop frequencies of the plug-in, the plug-in self test passed. This verifies the instrument bus to the plug-in, data and address busses on the A3 digital interface assembly, and plug-in ROMs. Any plug-in failures which are traced back to the A3 assembly are due to failures in one or more of the following areas:

- Address Decoding
- Plug-in Buffers
- Interrupt Control/Configuration Switch
- Miscellaneous Control Lines

If the HP 8350 displays show the wrong frequencies, first check configuration switch S1 against the information given in Section III, then troubleshoot the PIA, A3U4 with the information given under error code E053, above.

Address Decoder

The primary address decoding for the plug-in occurs on the A3 assembly (Block B). The enable lines are then passed on to the rest of the instrument. The major address decoder test can be utilized to check all these lines. On the HP 8350 enter:

[SHIFT] [5] [3]

Major Address Decoder Test

Then check the outputs of A3U6B, A3U6C, A3U7B, A3U9, and A3U13 for the signals shown in Figure 8-20, *Major Address Decoder Self-Test Timing Diagram*. The address lines have been verified by the instrument self test routine. Therefore, if the LPIAE or ROM enable lines are faulty, suspect one of the discrete address decoding ICs: A3U6, A3U7, A3U8, and A3U10. If other pulses are missing or displaced, replace the appropriate decoder: A3U9 or A3U13.

Plug-in Interface

A3U14 and A3U17 (Block F) buffer the address and data lines for use throughout the plug-in. The address and data busses on the A3 assembly have been verified by the instrument self test. Therefore, if address or data is not being passed to another assembly, the fault lies with A3U14, A3U17, A3U6A, or a motherboard connection.

The address lines can be exercised by performing the minor address decoder test. On the HP 8350, enter:

[SHIFT] [5] [4] Minor Address Decoder Test

Verify both high and low pulses on each of the buffered address lines (BA0-BA3), as well as activity on the L INST1 and L INST2 lines.

Data lines can be verified by performing a data rotation write to any address location between 2C0H and 2FFF. On the HP 8350, enter:

[CW] [SHIFT] [0] [0] [2] [GHz s] [0] [0] [M4]	Set HP 8350 to CW mode Direct Component Address mode Address location 2C00 Hex Data Rotation Write
--	---

Check for activity on each of the buffered data lines (BD0 – BD7), and check for shorts between lines.

Interrupt Timer/PIA

The PIA is responsible for two functions:

- Reading the Configuration Switch
- Routing the L SIRQ Interrupt from the A6 assembly

NOTE: Before changing the configuration switch setting, write down the current switch positions and return the switches to their original positions after troubleshooting.

The PIA's read capability can be checked by entering:

[CW] [SHIFT] [0] [0] [2] [9] [0] [0] [M3] (Hex Data Read of address 2900)

Check that the display changes as each section of the configuration switch is toggled.

The triple timer and PIA's interrupt masking capabilities are tested using a special routine at [INSTR PRESET] or power-on. Error Codes E052 or E053 are displayed if an error is detected. If these error codes are found, refer to the earlier discussion of these error codes. If you suspect that either A3U4 or A3U5 are bad, a special test pattern can be accessed by entering:

[SHIFT] [5] [5] Interrupt Control Test

The waveforms shown in Figure 8-19 should be present. The discussion of E052 and E053 explain troubleshooting tips for this failure.

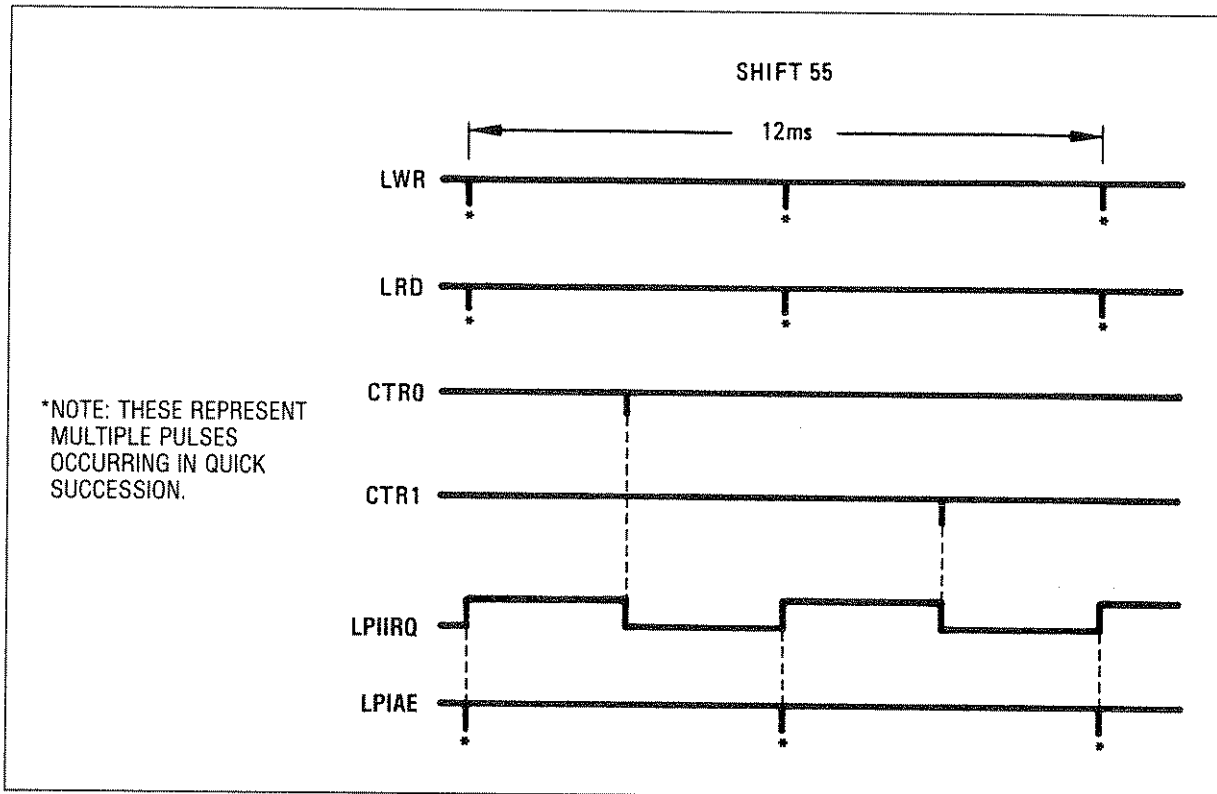

Figure 8-19. Interval Timer Self-Test Timing Diagram

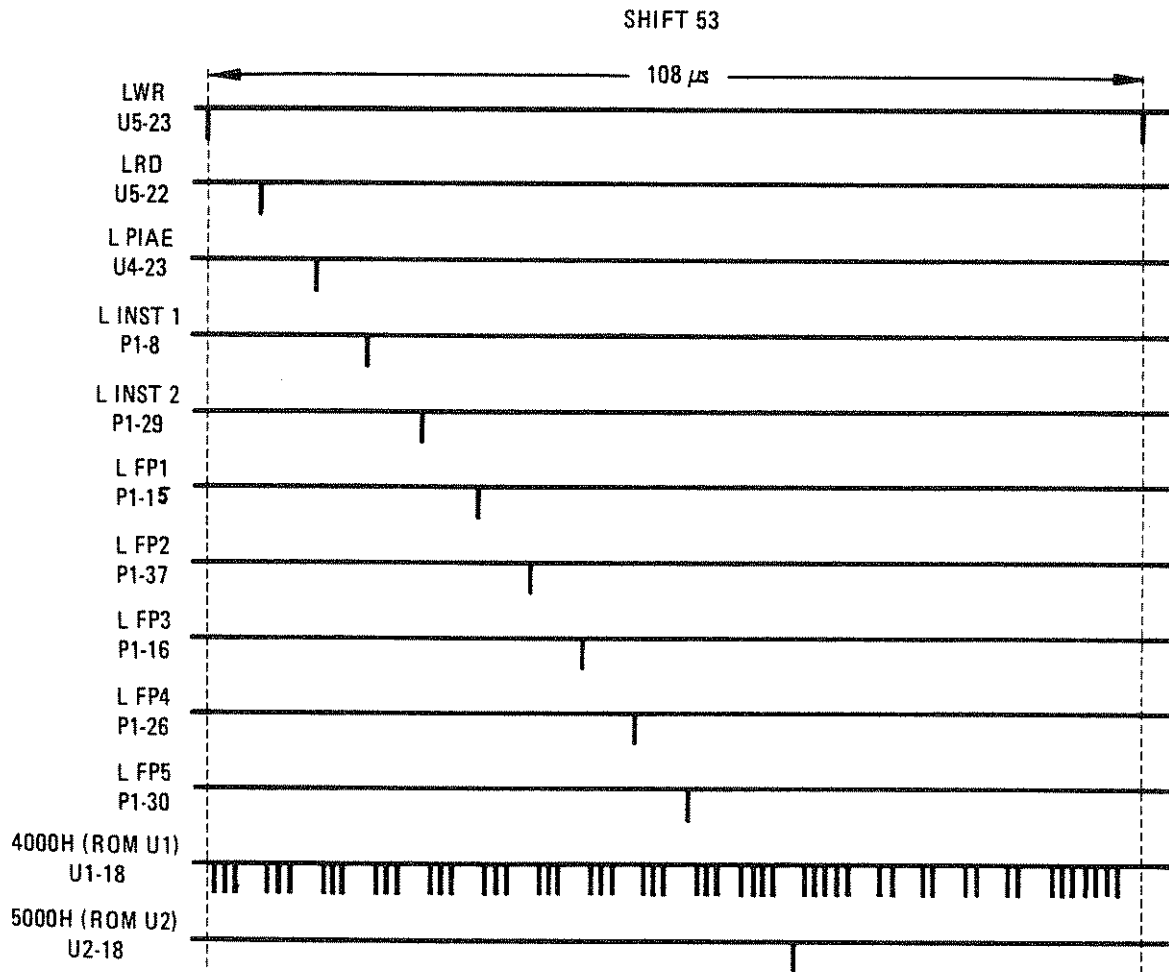

Figure 8-20. Major Address Decoder Self-Test Timing Diagram

A3 Digital Interface Circuit Description

INTRODUCTION

The A3 digital interface assembly receives digital address, data, and control signals from the HP 8350 sweep oscillator mainframe. These signals are processed and then routed to the rest of the plug-in. The ROM (read only memory) ICs A3U1 and A3U2 contain firmware dedicated to the specific model of plug-in. The interrupt control circuit in Block E creates interrupt requests at the beginning and end of each sweep. The A3 digital interface also provides data and timing information for the A1 front panel assembly, as well as data, address and control signals for the rest of the plug-in.

SWEEP OSCILLATOR INTERFACE, BLOCK A

The digital data, address, and control signals from the HP 8350 sweep oscillator mainframe pass through the RF plug-in interconnect and ribbon cable to J1 on the A3 digital interface. They are buffered and inverted by Schmitt trigger inverters before passing on to the rest of the RF plug-in. 100 Ohm resistors in series with each line are included to reduce ringing on the instrument bus. A3U7A and A3U7D enable the bi-directional data buffer when either the plug-in ROMs (via L PIROME) or the plug-in itself (via L I/O E2) is enabled. Lastly, A3U10F receives the FLAG from the A1 front panel assembly and passes it back to the HP 8350 sweep oscillator mainframe.

ADDRESS DECODER, Block B

The address decoder decodes the address and control lines to provide control signals throughout the RF plug-in. Table 8-9, *Digital Interface Address Decoding*, shows the decoded address lines and where they are used in the plug-in.

ROM, BLOCK C

The RF plug-in's read only memory consists of two 4K by 8 bit ROMs. This memory contains all firmware programming dedicated to the RF plug-in for use by the processor in the HP 8350. Addresses 4000 through 4FFF are read from A3U1, while 5000 through 5FFF are read from A3U2. The A12 line, decoded in the address decoder, selects which ROM is enabled. The remaining twelve address lines (A0 through A11) determine the individual ROM address being read.

200 kHz CLOCK, BLOCK D

A3U3 is a simple oscillator with external timing elements configured to provide a stable 200 kHz pulse train. This signal is used on the A1 front panel to scan the keyboard and refresh the display.

INTERRUPT CONTROL/CONFIGURATION SWITCH, BLOCK E

Triple programmable counter A3U5 is not used in single band plug-ins (like this one).

A3U4 is a peripheral interface adapter (PIA) which controls the L SIRQ interrupts from A6 and reads the configuration switch, S1. As an interrupt controller, A3U4 can be microprocessor programmed to mask or enable any of four possible interrupts. In the HP 83570A, only the L SIRQ line is enabled to cause a plug-in interrupt (L PIIRQ).

Configuration Switch S1 is encoded with information about the type of RF plug-in and the options included (the HP 83570A is not offered with any options), as well as operator chosen parameters such as FM sensitivity and power-up conditions. Refer to Section III for details. The HP 8350 processor addresses A3U4 to read the switch status at power-on or when subsequent calculation involving frequency range, power range, marker values, or many other plug-in dependent parameters occurs.

RF PLUG-IN INTERFACE, BLOCK F

A3U17 and A3U14 buffer the address and data signals required throughout the rest of the RF plug-in. A3U17 is a bi-directional, 8-bit data buffer which is enabled when BI/OSTB, A10, and BI/OE2 are all high. Its direction is controlled by the L WRITE line. A3U14 is enabled by L BI/OE2 to pass four address lines (A0 through A3) to the rest of the RF plug-in's circuitry.

Table 8-9. Digital Interface Address Decoding

Mnemonic	Address	Address Decoder Components	Components Addressed	Read or Write	Description
L WR	2800H to 287FH	U9	A3U5	Write	Write data to programmable interval timer.
L RD	2880H to 28FFH	U9	A3U5	Read	Read data from programmable interval timer.
L PIAE	2900H to 29FFH	U7B, U7C, U8A, U10D	A3U4	RD/WR	Enable Peripheral Interface Adapter. (Also addressed 2B00H to 2BFF)
L INST1	2C00H to 2C7FH	U10D, U13	A4, A5, A7	Write	Write control for A4 ALC, A5 FM Driver, and A7 Bias.
L INST2	2C80H to 2CFFH	U10D, U13	A6	RD/WR	Write to A6 YO Driver control and read YO Gain and Offset switches.
L FP1	2D00H to 2D7FH	U10D, U13	A1	Write	Write to front panel displays.
L FP2	2D80H to 2DFFH	U10D, U13	A1	Read	Read front panel keyboard.
L FP3	2E00H to 2E7FH	U10D, U13	A1	Write	Write to front panel annunciators.
L FP4	2E80H to 2EFFH	U10D, U13	A1	Write	Write to front panel annunciators.
L FP5	2F00H 2F7FH	U10D, U13			Not Used.
L ROM1	4000H to 4FFFH	U6C, U10A, U10B	A3U1	Read	Enable ROM U1.
L ROM2	5000H to 5FFFH	U6B, U10B	A3U2	Read	Enable ROM U2.

Table 8-10a. Connector Pin Descriptions

A3P1		PIN	SIGNAL	I/O	TO/FROM	FUNCTION
1	23	NC	NC			
2	24	NC	NC			
3	25	NC	NC			
4	26	GND DIG L FP4		OUT	A1J1-24	G B
5	27	GND DIG NC				G
6	28	+5V NC		OUT		G
7	29	+5V L INST2		OUT OUT	A6P1-18	G B
8	30	L INST1 L FP5		OUT OUT	A4/A7/A5 Not Used	B
9	31	BD1 BD0		I/O I/O	Buf. Data Bus Buf. Data Bus	F F
10	32	BD3 BD2		I/O I/O	Buf. Data Bus Buf. Data Bus	F F
11	33	BA1 BA0		OUT OUT	Buf. Addr. Bus Buf. Addr. Bus	F F
12	34	BA3 BA2		OUT OUT	Buf. Addr. Bus Buf. Addr. Bus	F F
13	35	BD5 BD4		I/O I/O	Buf. Data Bus Buf. Data Bus	F F
14	36	BD7 BD6		I/O I/O	Buf. Data Bus Buf. Data Bus	F F
15	37	L FP1 L FP2		OUT OUT	A1J1-3 A1J1-1	B B
16	38	L FP3 SCAN CLK		OUT OUT	A1J1-20 A1J1-23	B E
17	39	NC NC				
18	40	L SIRQ NC		IN	A6P1-3	E
19	41	NC NC				
20	42	NC FLAG		IN	A1J1-25	A
21	43	NC NC				
22	44	PWON NC		IN	P2-25	E

Table 8-10b. Connector Pin Descriptions

A3J1				
PIN	SIGNAL	I/O	TO/FROM	FUNCTION
1	GND DIG			G
2	ID0	I/O	P2-33	A
3	ID1	I/O	P2-2	A
4	ID2	I/O	P2-34	A
5	ID3	I/O	P2-3	A
6	ID4	I/O	P2-35	A
7	ID5	I/O	P2-4	A
8	ID6	I/O	P2-36	A
9	ID7	I/O	P2-5	A
10	GND DIG			G
11	GND DIG			G
12	L IA0	IN	P2-38	A
13	L IA1	IN	P2-38	A
14	L IA2	IN	P2-39	A
15	L IA3	IN	P2-8	A
16	L IA4	IN	P2-40	A
17	GND DIG			G
18	L IA5	IN	P2-41	A
19	L IA6	IN	P2-10	A
20	L IA7	IN	P2-42	A
21	L IA8	IN	P2-11	A
22	L IA9	IN	P2-43	A
23	L IA10	IN	P2-12	A
24	L IA11	IN	P2-44	A
25	L IA12	IN	P2-13	A
26	PIROME	IN	P2-45	A
27	GND DIG			G
28	GND DIG			G
29	L IRD	IN	P2-15	A
30	I/OE2	IN	P2-47	A
31	GND DIG			G
32	GND DIG			G
33	L I/OSTB	IN	P2-17	A
34	GND DIG			G
35	+5VB	IN	P2-18	G
36	+5VB	IN	P2-50	G
37	NC			
38	+5VB	IN	P2-51	G
39	L PIFLG	OUT	P2-20	A
40	L PIIRQ	OUT	P2-52	E
41	GND DIG			G
42	NC			
43	NC			
44	NC			
45	NC			
46	NC			
47	NC			
48	NC			
49	NC			
50	NC			

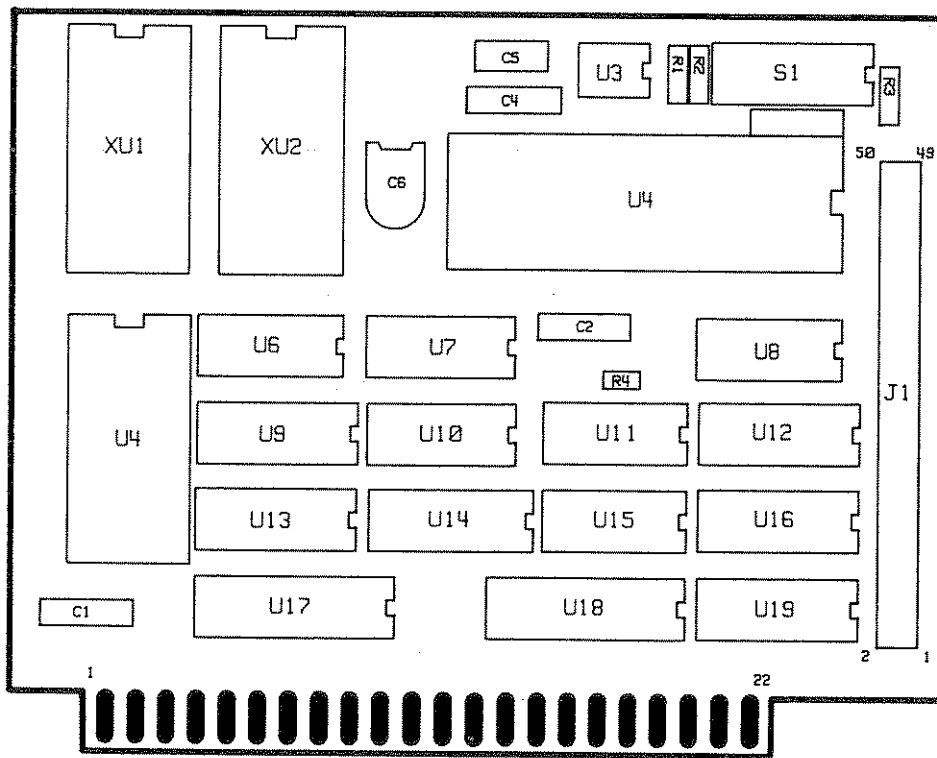
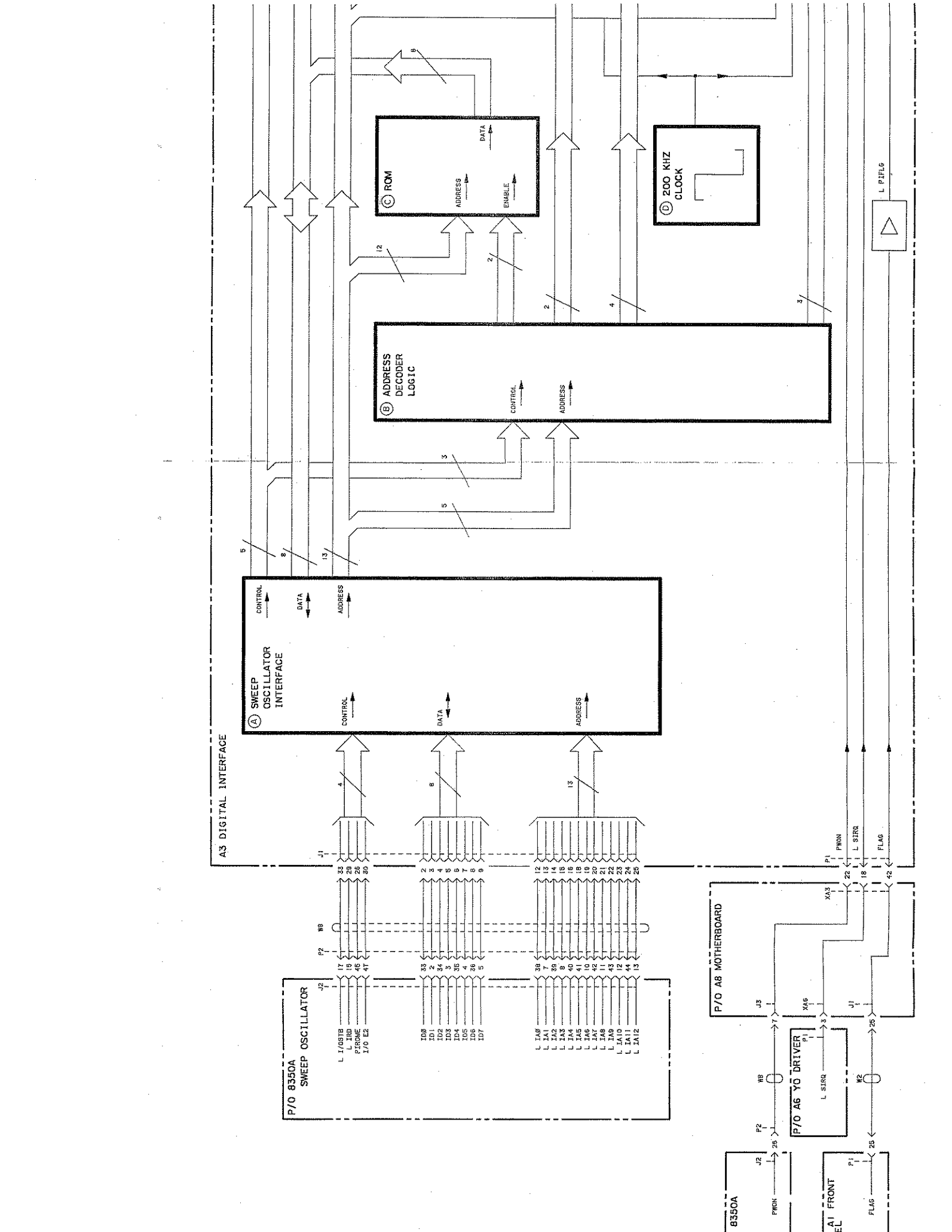

Figure 8-21. Digital Interface Component Locations



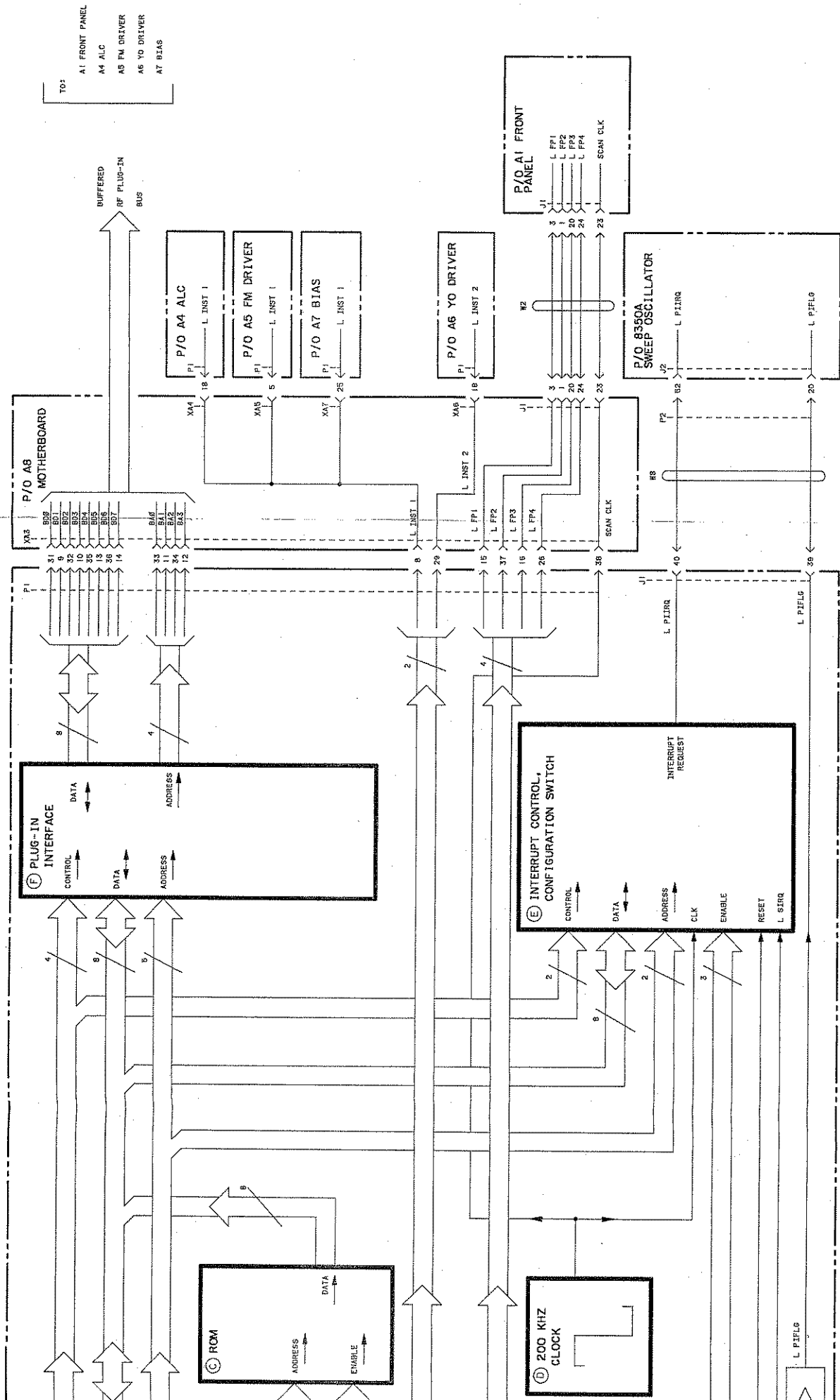
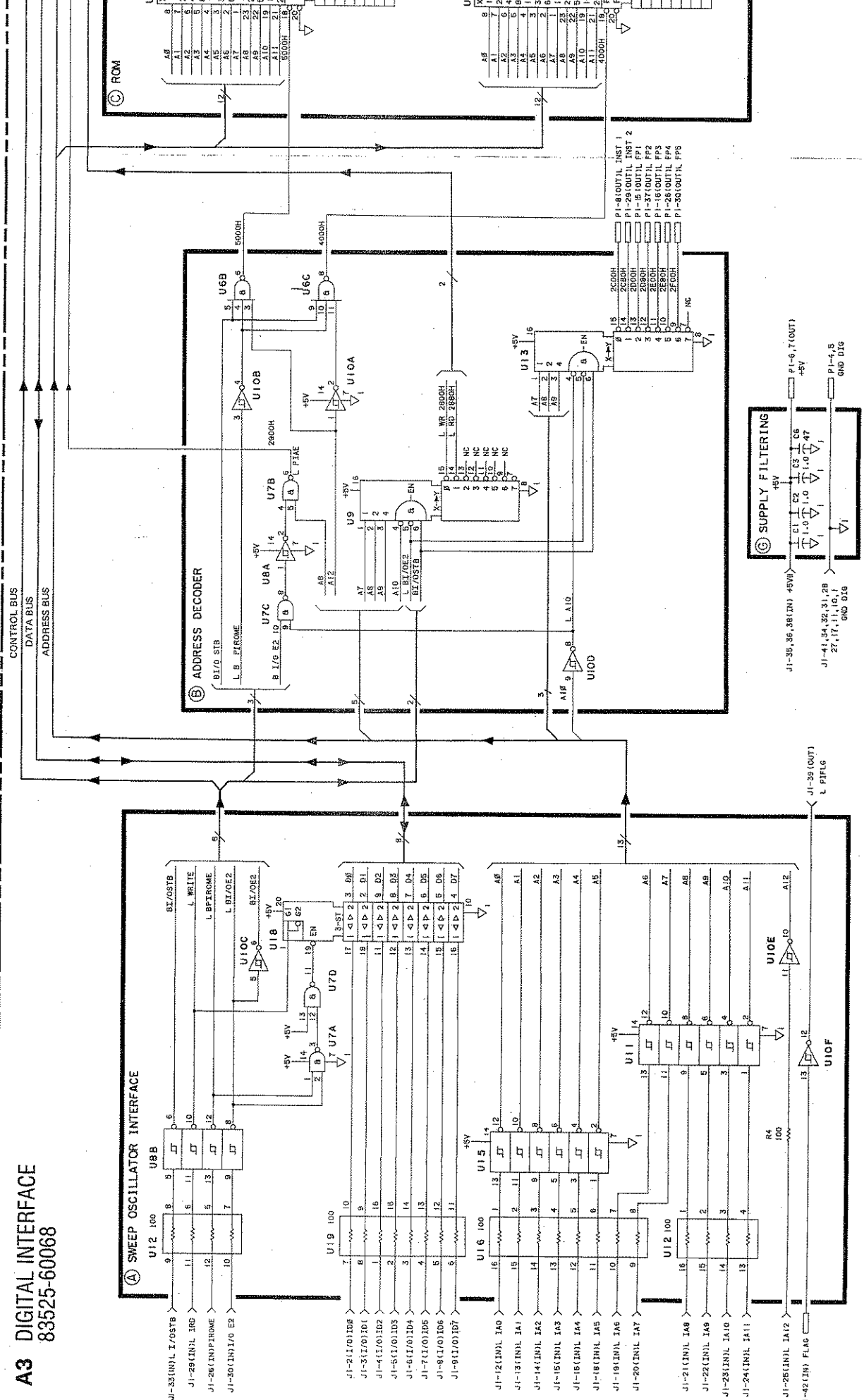
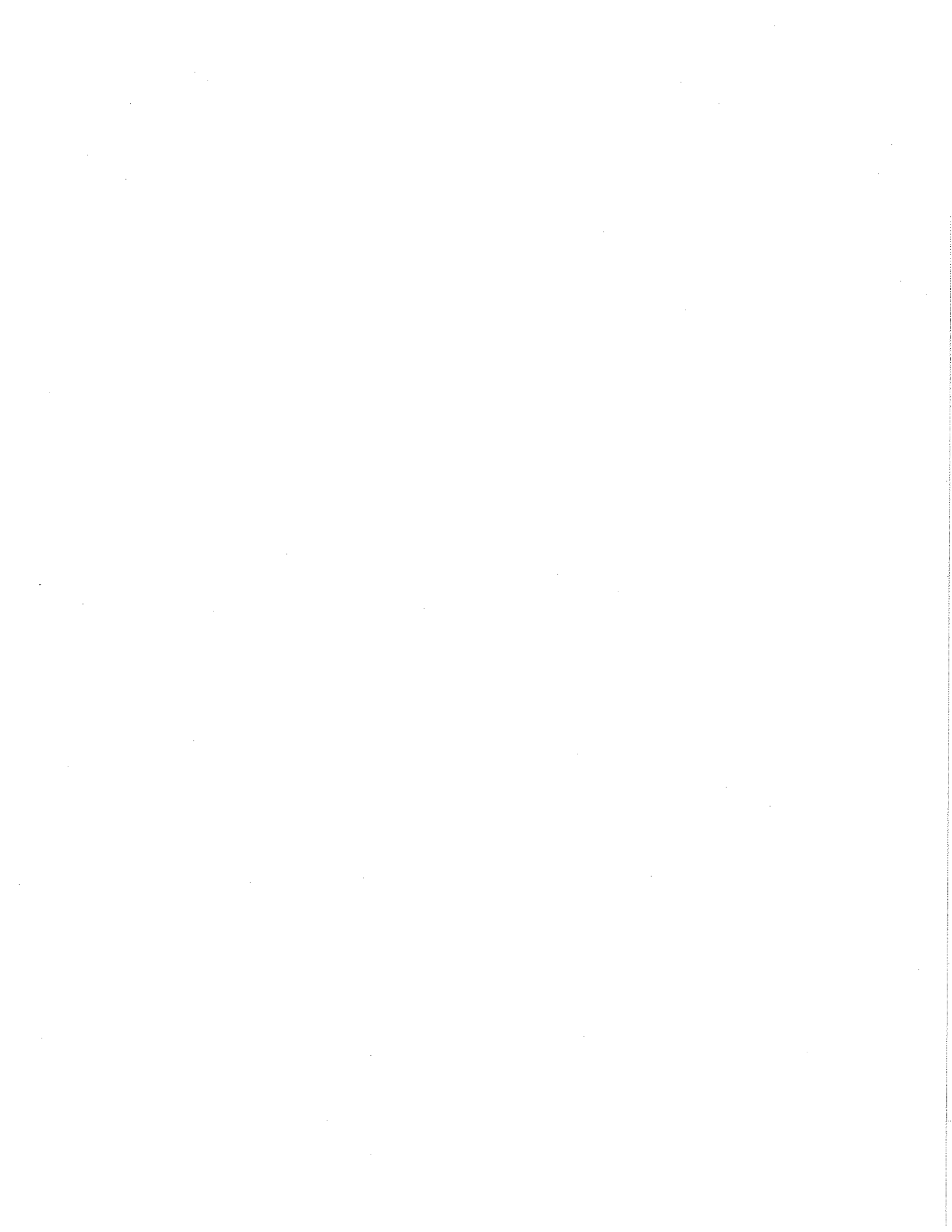

Figure 8-22. A3 Digital Interface, Overall Block Diagram

A3 DIGITAL INTERFACE 83525-60068





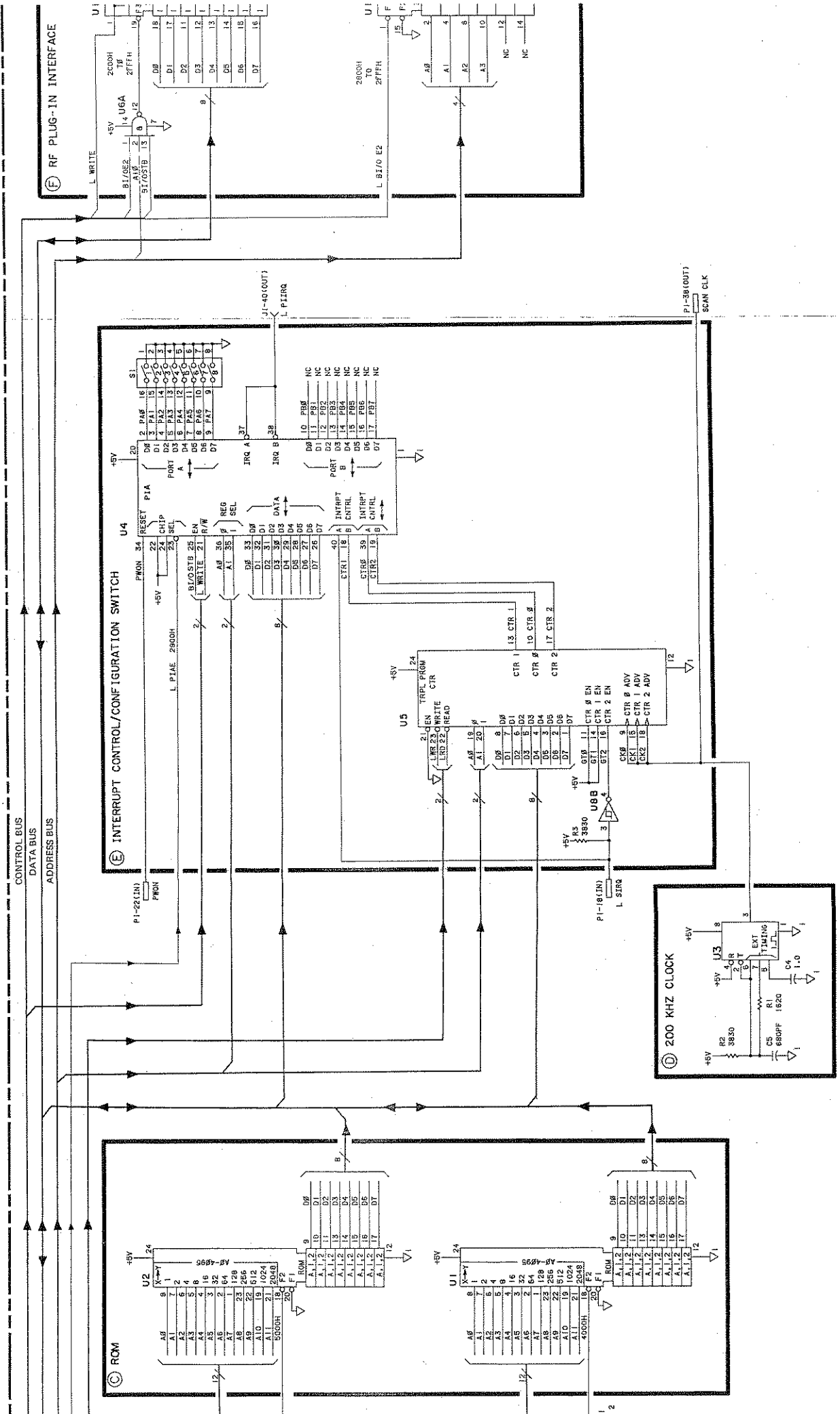

Figure 8-29.



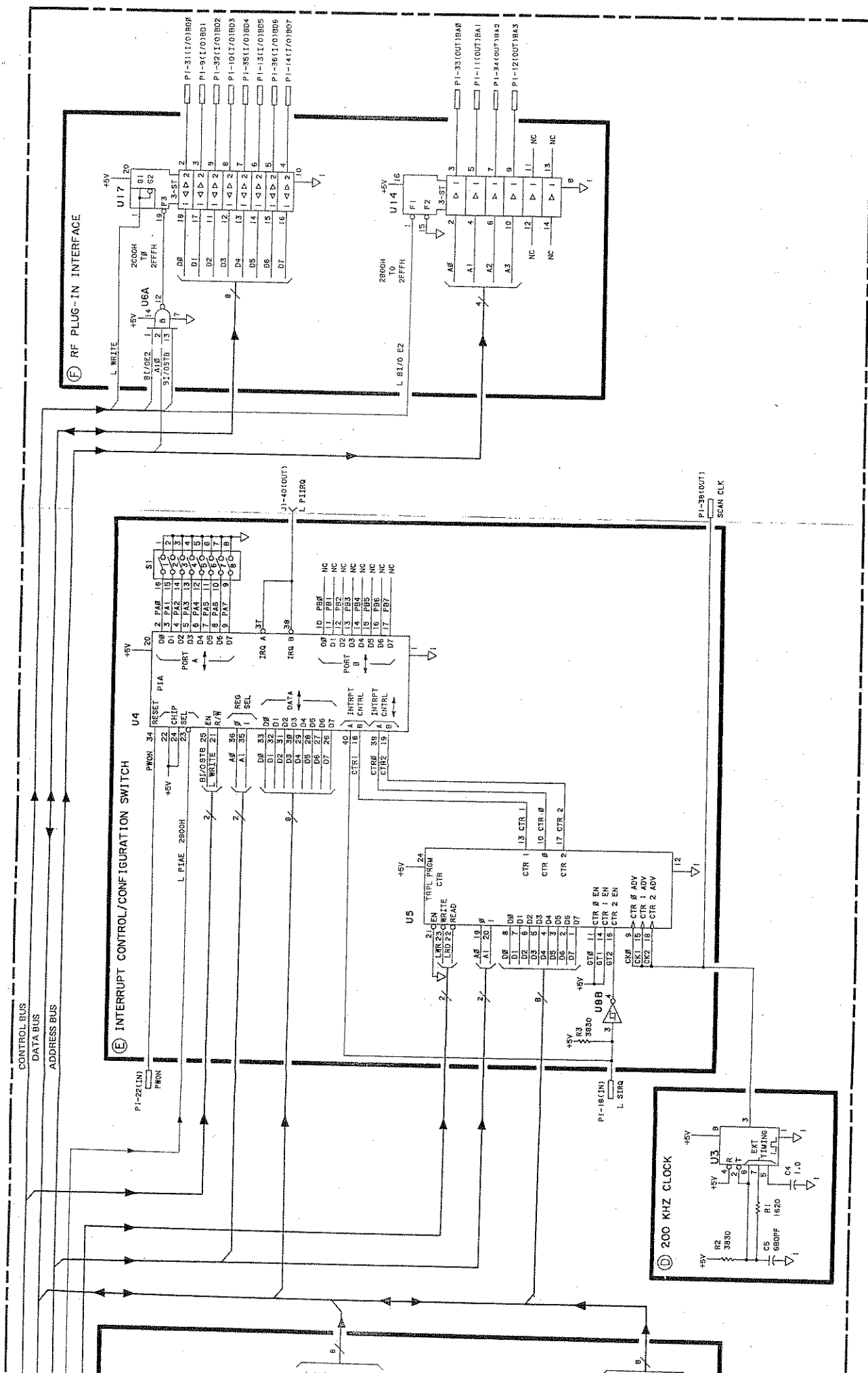

Figure 8-23. A3 Digital Interface, Schematic Diagram

A4 ALC Troubleshooting

INTRODUCTION

Since the automatic leveling control (ALC) function of the HP 83570A RF plug-in includes many individual components arranged in a highly interdependent closed loop, the scope of the A4 ALC troubleshooting section extends well beyond the confines of the A4 assembly. Portions of the A5 FM driver assembly and several microcircuit components which contribute to the power leveling function, are discussed below.

The ALC loop is a complex feedback loop which monitors the RF output power and continuously corrects for any deviation from the desired power level. Because it is a closed system, it is difficult to isolate cause from effect when a problem arises. Therefore, the key to troubleshooting is to examine individual components, correlating the expected output for a particular input signal.

This troubleshooting outline is organized into two major sections:

- **Troubleshooting Symptoms**
 - Characterizes possible failure modes
 - Provides general troubleshooting information
 - Refers to detailed diagnostic procedures
- **Troubleshooting Diagnostics**
 - Organized functionally, by schematic block
 - Provides Hex Data access and operator-initiated self tests
 - Intended for repair to component level

TROUBLESHOOTING SYMPTOMS

The procedures outlined below help to systematically characterize the failure as quickly as possible. The following failure symptoms are discussed:

- **RPG/Power Display Failure**
- **UNLEVELED LED is on (regardless of whether or not an unlevelled condition actually exists)**
- **Flatness/Oscillations (Power Dropouts)**
- **Full Unlevelled Power**
- **No Power**
- **Power Sweep/Power Sweep Flatness**

Evaluating the specific failure may require an HP 436A power meter or the HP 8757A scalar network analyzer with the HP 85025B detector. (However, a crystal detector with an A vs. B oscilloscope may often be substituted.) Figure 8-24 configures a typical test setup. Initiate all tests with the INSTR PRESET condition.

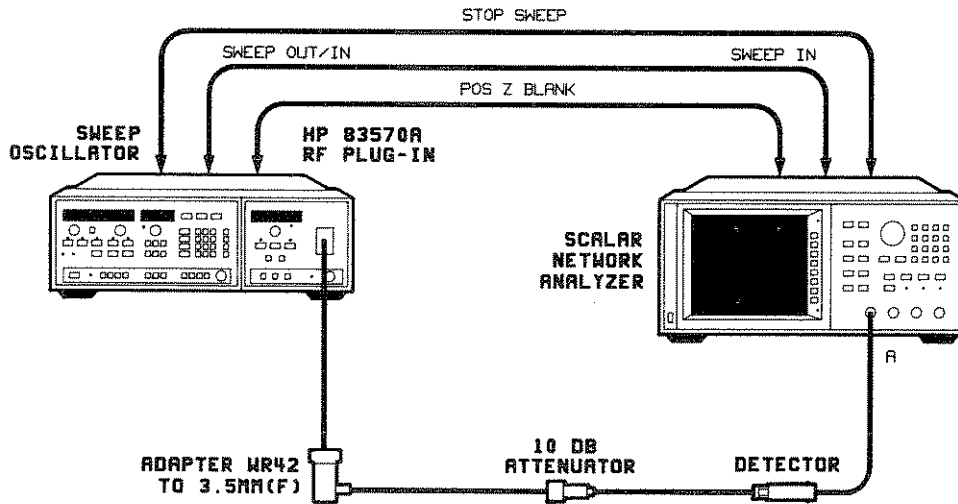

Figure 8-24. Typical ALC Troubleshooting Setup

RPG/POWER DISPLAY FAILURE

Check that the POWER display changes when either the RPG is turned or data is entered via the HP 8350 keyboard. This verifies that the digital information is reaching the HP 8350, being processed properly, and being displayed properly by the plug-in.

If the display is flashing rapidly or showing random patterns, refer to the A1 front panel or A3 digital interface troubleshooting sections.

If the RPG causes a change in the measured RF power level, but the POWER display remains the same, refer to the A1 front panel troubleshooting section.

If the RPG produces no response, or if the front panel display is blank, refer to the A1 front panel troubleshooting section, and trace the problem back to the HP 8350.

UNLEVELED LED IS ON

Note that this error condition can occur independent of an actual unlevelled power condition. Comparator A4U10 enables the front panel UNLEVELED LED when the voltage at its non-inverting input drops below approximately -0.6 Vdc, indicating that the RF output is insufficient to level to the desired power reference.

- Before inspecting loop components, determine whether the UNLEVELED LED is on during forward sweep or retrace. Enter a sweep time of 5 seconds. If the UNLEVELED LED remains on during retrace (when the sweep LED goes out), suspect problems with the annunciator drivers for the UNLEVELED LED. Refer to the A7 bias assembly troubleshooting section for information.
- If the UNLEVELED LED remains on during the entire forward sweep, check the RF output power with a power meter. If minimal RF output power is recorded, refer to the **No Power** section.
- If the UNLEVELED LED flashes briefly during the sweep, and remains off during retrace, check power flatness, below.

POWER FLATNESS/OSCILLATIONS (POWER DROPOUTS)

Monitor the RF output with the HP 8757A as shown in Figure 8-24.

- If the power level across the sweep is within approximately 5 dB, then the plug-in may only require ALC flatness adjustments. Refer to Section V, Adjustments.
- If the measured power level lies between $+10$ and -1 dBm, but cannot be controlled via the front panel, refer to the digital control section under **Troubleshooting**.
- If the trace appears chopped or broken, the loop may be oscillating. Refer to Section V, Adjustments, and perform the ALC gain adjustment procedure.

FULL UNLEVELED POWER

If power is unlevelled, continue to sweep the plug-in's full range.

- Attempt to level the power externally using the HP 436A power meter as shown in Figure 8-25, *Power Meter Leveling Setup*. Select MTR leveling, and enter a slow (at least 50 second) sweep time. If the RF power is now leveled, the failure is most likely in the detectors or the detector selection switch, A4U6. Refer to the following paragraph. If this is not the case, the problem may be in the two analog switches A4U3B and A4U6A. It may be necessary to perform the ALC adjustments in Section V, Adjustments.

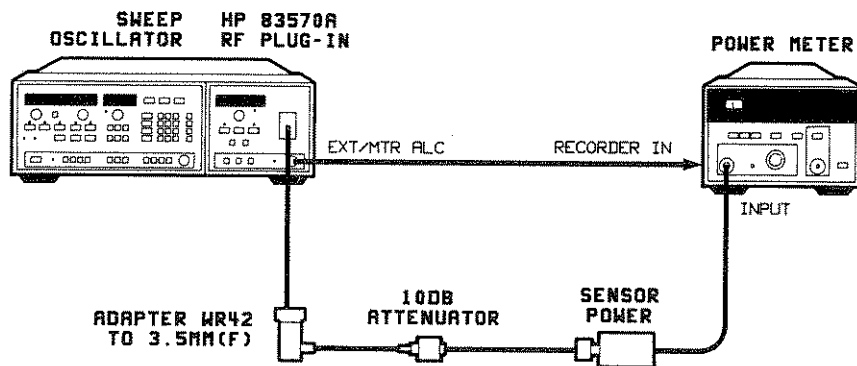

Figure 8-25. Power Meter Leveling Setup

- Check the detector selection switch by entering a CW frequency in the leveling mode in question and trace the detector voltage through A4U6B. If the input to be selected does not match the output, check the MUX A0B and MUX A1B lines (see Table 8-12). Also check A4U12 and A4U13 (Block L) as described under Digital Control.
- Check the voltage at TP5. If TP5 is greater than or equal to +8.9 Vdc, suspect the modulator driver on the A2A1 assembly, or the modulator diodes in the A2 microcircuit. If TP5 is below +4 Vdc, suspect the detectors and detector leg.

NO POWER

NOTE: Turn off AC power before removing or installing any assembly.

- To check RF components, remove the A4 ALC assembly from its socket. This removes all bias from the modulator, and should allow maximum power through the RF path. If full power (over +12 dBm) is then measured, the YIG oscillator A9 and the A2A2 doubler are verified. Suspect primarily the detector, inside A2A2. Also suspect the modulator (part of A2), as well as the modulator driver on A2A1 or the detector selection switch on A4.
- If there is still no power when the A4 assembly is removed from the instrument, suspect the YIG oscillator A9 or doubler A2A2. Refer to A2 troubleshooting.
- If removing the A4 assembly causes full unlevelled RF power to appear, reinstall the board and check A4TP5. If less than +4 Vdc is present, check continuity from A4TP5 to the modulator driver circuit A2A1J3 pin 11. If A4TP5 is at +8.9 Vdc, suspect any circuitry between the detector selection switch and A4TP5, particularly the log amplifier (Block G).
- Refer to Figure 8-25a, *RF Blanking*. Press [RF BLANK] and check L RFB line, A4P1-29. If it is stuck low, the loop will shut down the RF.
- If the failure has not been located, suspect components of the RF path.

POWER SWEEP/FLATNESS

- If power increases smoothly with frequency, and POWER SWEEP is NOT selected, suspect the A5 FM driver assembly.
- Remove the A5 board from the plug-in. If the situation improved, suspect a failure on the A5 assembly.
- If the RF power is leveled within approximately 5 dB, refer to Section V, Adjustments, and perform the internal leveled flatness adjustment procedure.

TROUBLESHOOTING DIAGNOSTICS

The troubleshooting information below is organized into functional areas:

DIGITAL CONTROL, BLOCK A
REFERENCE POWER LEVEL, BLOCKS C and H
DETECTOR/DETECTOR SELECTION SWITCH, BLOCK B
DETECTOR LEG, BLOCKS E, F, and G
MODULATOR LEG, BLOCKS I and L
MOD DRIVER A2A1
MODULATOR A2

DIGITAL CONTROL, BLOCK A

Address decoder A4U12 and control latch A4U13 control digital switches throughout the A4 assembly. Their operation can be confirmed by performing the hex data rotation write at address 2C07 Hex. Enter the following keystrokes:

[SHIFT] [0] [0] [2] [GHz s] [0] [7] [M4]	Direct Component Address mode Address location 2C07 (U13) Perform Hex Rotation Write
--	--

Check the outputs of A4U13 for the waveforms shown in Figure 8-2.

- If any output signal is missing or misplaced, check the data lines against Figure 8-2. If no output is found, look for activity at A4U13 pin 11. Check for L INST1 and BA3 to pulse low, while BA0, BA1, and BA2 pulse high. If these pulses are missing, trace the problem back to the A3 digital interface assembly.

If the digital control section is working, the primary outputs of A4U13 are easily controlled by selecting the appropriate front panel function while in the CW mode. (e.g., selecting MTR leveling holds the PM line high, etc.).

POWER LEVEL REFERENCE, BLOCKS C and H

The power level reference leg produces a voltage proportional to the desired power level. This signal is a summation of the absolute power reference, AM, ALC compensation, and power sweep signals.

The ALC compensation and power sweep signals are generated on the A5 FM driver assembly. If an A5 failure is suspected, refer to troubleshooting information in the A5 assembly section. Unless A5 is suspect, simplify A4 troubleshooting by turning off the line power and removing the A5 assembly. Although power sweep will be disabled and the power flatness will be lost, the ALC loop should still level without the signals provided by the A5 assembly.

DAC A4U11 establishes the absolute power level. The -10V REF from the A6 assembly is scaled to yield from 0 Vdc (-1 dBm displayed) to the $+8.4\text{ Vdc}$ ($+19\text{ dBm}$ displayed) at TP2. (This breaks down to a voltage step of 0.42 Vdc per 1.0 dB of power over the dynamic range, or 4.62 Vdc at $+10\text{ dBm}$)

A self test routine is available to exercise the ALC DAC, Enter:

[SHIFT] [5] [0]

The waveform in Figure 8-26, *DAC Test*, should be seen at TP2. Note that the exercise routine for the 12-bit DAC yields a staircased waveform with 13 levels. The first step shows the maximum $+10\text{ Vdc}$ output with all bits high. The following levels represent the voltage at TP2 with successive bits loaded high in order from the most significant bit to the least significant bit.

- If the waveform at TP2 is not correct, check for -10V REF , and trace any problem back to the A6 assembly. Look for activity on L INST1, BA0, and BA1. BA2 and BA3 should pulse high as each new DAC value is loaded, pulsing the CS line (A4U11 pin 8) low. If any of these lines, or data line, appears dead, trace the problem back to the A3 assembly. If the input lines are correct, replace A4U11.

PWR SWP/COMP and AM is summed with the DAC voltage at the input to A4U2A. CR1 provides detector flatness compensation at higher power levels. Use the EXT MTR mode to bypass this diode while troubleshooting.

A4U2C adds the front panel amplitude adjustment (EXT CAL) used with external leveling. It also adds a scaled tuning voltage (FREQ TRK V) which is proportional to frequency. This ramp works with the PWR SW/COMP signal from the A5 assembly to accomplish the flatness compensation adjustments. Therefore, when the A5 assembly is removed, an offset ramp is seen at TP1. An amplitude modulation (AM) signal of 1.0 V p-p at P1-4 will produce roughly 260 mV p-p at TP1. (Note that A4U3A and A4CR1 in the feedback path around A4U2A change the gain depending on the desired power level).

DETECTOR/DETECTOR SELECTION SWITCH, BLOCK B

The detector (internal to the A2A2 doubler microcircuit) is tested simply by checking its output voltage under full leveled power or full unleveled power conditions. Table 8-11 provides the approximate signal levels.

- If no power is measured, turn off the line power and remove the A4 assembly. Return power to the instrument. (If there is still no RF power, suspect components of the RF path.) If full unleveled RF power is obtained, apply a narrow strip of cellophane tape to the PC board edge connector at P1-22 to isolate the MOD DRIVE signal from the modulator. Reinstall the A4 board. This removes bias from the modulator, allowing full RF power transmissions while providing detector bias.
- If full leveled power (+10 dBm) or full unleveled power (+12 dBm) is measured, check the voltage at the detector input against the values shown in Table 8-11. (Use high impedance 10:1 probes.)

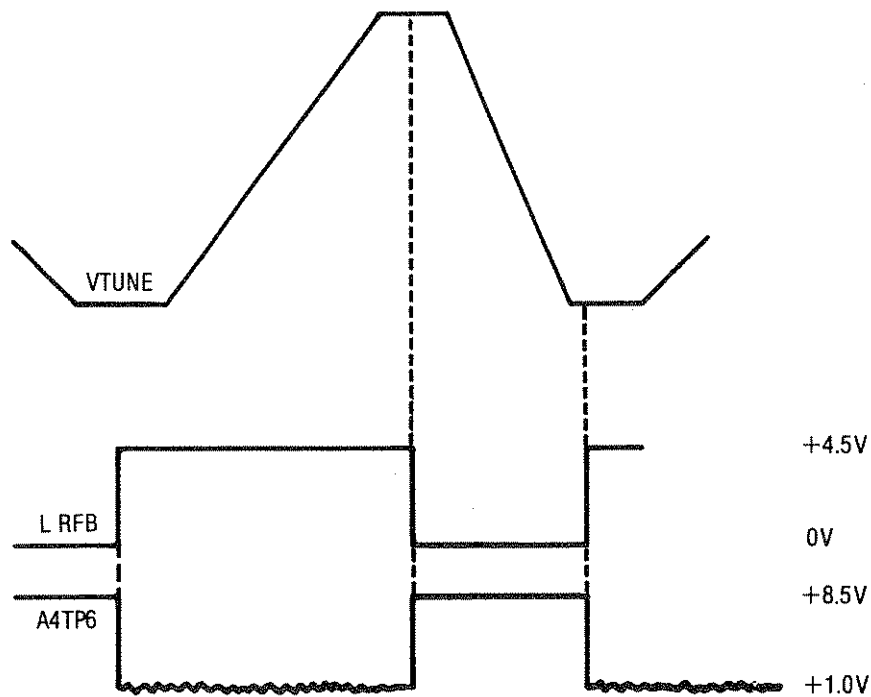

Press HP 8350 [RF BLANK].

Figure 8-25a. RF Blanking

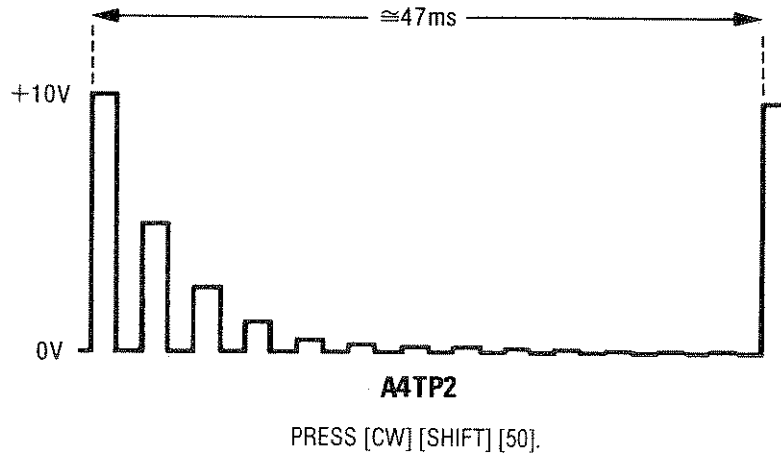

Figure 8-26. DAC Test

Table 8-11. Detector Voltages

A4P1-20	Full Leveled +17 dBm	Full Unleveled +26 dBm
	-60 to -100 mV	-100 to -220 mV

- If the detector is working and the detector selector switch is suspected, monitor TP12 for the voltage seen at the selected input of A4U6B.
- If the EXT/MTR ALC input circuits are suspected, select the desired mode and supply a test signal (low-level dc or sine wave) in the front panel BNC connector, and trace it through A4U6B to A4TP12.

NOTE: Remove any tape applied to the edge connector pins in the previous procedure.

DETECTOR LEG, BLOCKS E, F, and G

The detector leg of the ALC loop includes components between the detector selection switch and the error summing amplifier, A4U2D.

Before troubleshooting the detector leg, be sure the detectors and detector selection switch are working correctly. See above.

The detector leg can be effectively tested by using the open loop method of troubleshooting. This procedure utilizes the external leveling mode (EXT) by supplying an external dc voltage or sine wave to the EXT/MTR ALC INPUT connector. This method breaks the ALC loop and allows waveforms to be checked against known test signals. See Figure 8-27, *Open Loop Procedure*.

MODULATOR LEG, BLOCKS I and L

The modulator leg includes the error sample & hold and main ALC amplifier.

A4U2D is a non-inverting unity-gain summing amplifier. Under leveled conditions, both A4U2D pin 10 and TP8 should be nearly 0.0 Vdc. Under any conditions (except during "hold"), A4U2D pin 10 and TP8 should be nearly 0.0 Vdc. If not, suspect A4U2D, A4Q5, or the sample & hold driver.

A4U9 is an inverting integrator. When TP8 is positive, TP5 should be at -1.2 Vdc. If not, suspect A4U1D or A4U9. When TP8 is negative, TP5 should be at $+8.9$ Vdc. If not, suspect A4U9.

The following procedure can be used to check A4U2D and A4U9:

1. Jumper A4TP11 to ground.
2. Set power for -1 dBm at any CW frequency.
3. Press the HP 83570A's [EXT] ALC key.
4. To check A4U2D, monitor A4U2D pin 10 and TP8 while adjusting the EXT/MTR ALC CAL pot between the extremes of its range. Both A4U2D pin 10 and TP8 should vary between approximately $+0.5$ and -0.5 Vdc.
5. Verify A4U9 by adjusting the CAL pot as described above and monitoring TP5. Since A4U9 is an integrator, TP5 should saturate and clamp (due to A4VR2, A4CR6, and A4CR13) at -1.2 Vdc and $+8.9$ Vdc, respectively.
6. Remove the jumper from A4TP11.

Further troubleshooting of the modulator leg can be continued by following the open loop procedure outlined in Figure 8-27, *Open Loop Procedure*, and checking for the waveforms provided in Figure 8-28, *Open Loop Waveforms*.

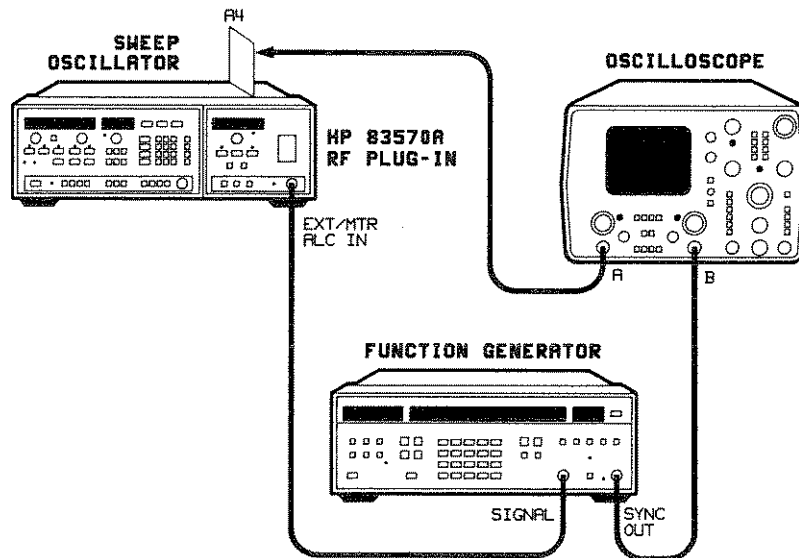

EQUIPMENT:

Function Generator HP 3325A
 Oscilloscope HP 1741A

PROCEDURE:

1. Press 8350 [INSTR PRESET].
2. Press 83570A [EXT] ALC.
3. Adjust function generator output for a 50 mV p-p sine wave at 500 Hz. Adjust the OFFSET for -25 mVdc.
4. Connect function generator output to EXT/MTR ALC connector.
5. Set oscilloscope DISPLAY to A and TRIGGER COMP to B. Check for the waveforms show in Figure 8-28.

NOTE: The HP 3325A OFFSET may have to be adjusted slightly to produce the waveforms given in Figure 8-28. If the EXT/MTR ALC input goes positive, the log amp will saturate.

Adjustment of the EXT/MTR ALC CAL screw will affect the waveforms at TP8 & TP5. Adjust the CAL screw until the correct waveforms are obtained.

Slight differences may be noted between the waveforms shown in Figure 8-28 and those obtained on individual ALC assemblies. This is due to the many adjustments on the A4 assembly.

Figure 8-27. Open Loop Procedure

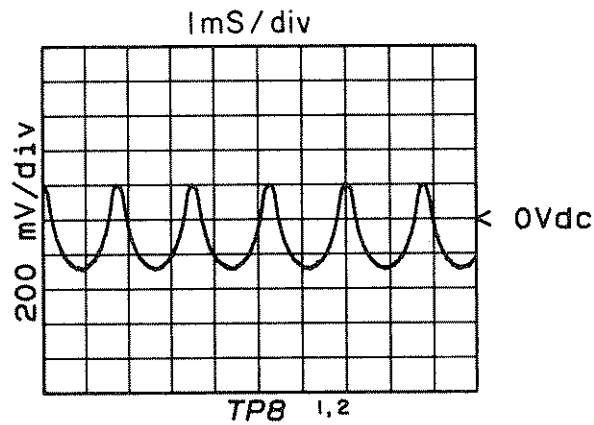
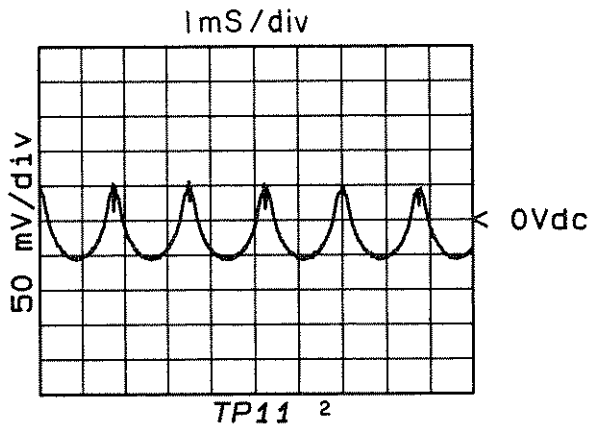
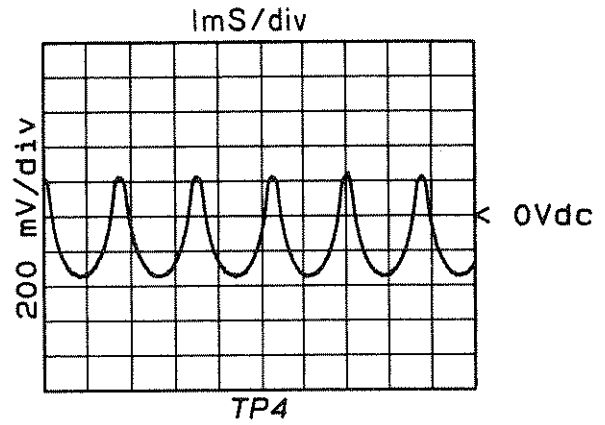
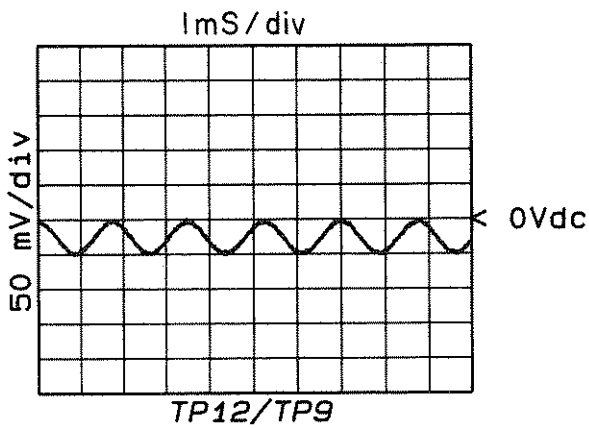

1. Power: 10 dBm. Offset depends on power level and EXT/MTR ALC CAL.
2. CW mode.

Figure 8-28. Open Loop Waveforms

MODULATOR DRIVER (Part of A2A1) and RF MODULATOR (Part of A2 Microcircuit)

NOTE: The mod driver circuit is located on the A2A1 pulse assembly, attached directly to the A2 doubler microcircuit. The internal RF modulator is inside the A2 microcircuit and cannot be replaced separately. Refer to the A2 service section for schematics, component locations, and additional troubleshooting information. The A2 microcircuit and A2A1 pulse assembly are not separately replaceable.



The A2 microcircuit is highly susceptible to damage from electrostatic discharge. Handle these components only when wearing a grounded wrist strap. Never place internal components on a work surface that is covered with indoor/outdoor carpet! The only recommended surface on which a microcircuit may be placed is a grounded anti-static mat.

The RF modulator in this plug-in is a negative bias shunt-type diode. Refer to Figure 8-29, *Simplified Modulator Schematic*. The mod driver provides the voltage-to-current conversion and current gain needed to drive the modulator. As the mod drive voltage at A4TP5 increases, the current drawn from the modulator by A2A1Q3 also increases, shunting more RF energy to ground and allowing less to pass through.

To establish a fixed voltage level for troubleshooting, A4TP5 can be forced high (+8.9 Vdc) or low (-1.2 Vdc). Ground TP11 on the A4 assembly. On the HP 83570A, select EXT ALC, and enter an RF power level of -1 dBm. Turn the EXT/MTR ALC CAL pot fully clockwise, verify a signal level of approximately +8.9 Vdc at A4TP5 and -0.9 Vdc at A2A1TP5. (The front panel UNLEVELED LED should not go on.) Turn the CAL pot fully counterclockwise and check for -1.2 Vdc at A2A1TP5. (In this case, the UNLEVELED lamp should light.)

During normal operation, A4TP5 should be approximately +0.7 Vdc, while A2A1TP5 should be close to -0.6 Vdc.

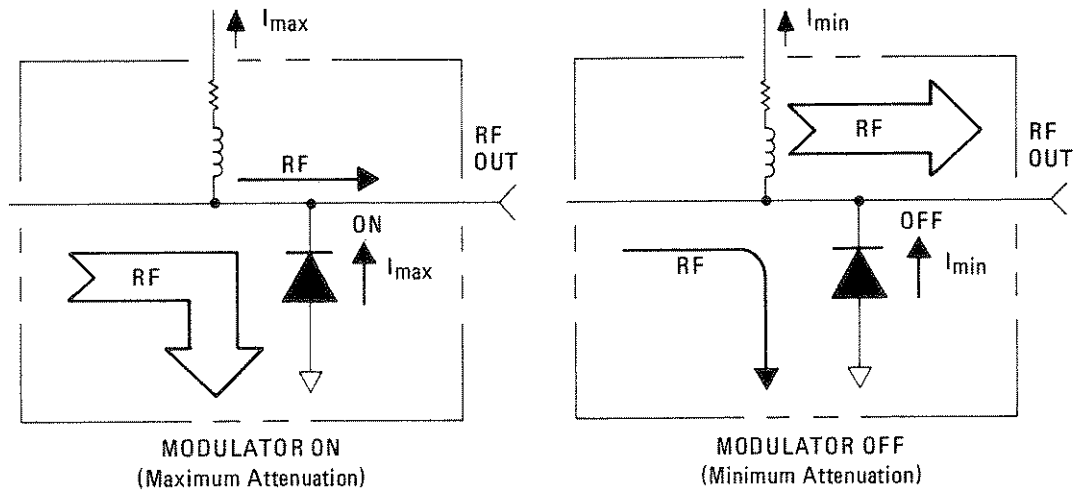

Figure 8-29. Simplified Modulator Schematic

Table 8-12 Modulator Bias Levels, provides the approximate bias levels for a properly functioning modulator assembly.

Table 8-12. Modulator Bias Levels

A4TP5	A2A1TP5
+8.9V	-0.9V (Minimum RF)
+0.7V	-0.6V (Leveled Operation)
-1.2V	+9.5V (Maximum RF)

NO RF POWER

NOTE: Turn off line power before removing or installing any assembly.

If the symptom is no RF power, remove the A4 ALC assembly. This will remove bias from the driver, turn A2A1Q3 off, and allow full RF power to pass through the modulator. If full unleveled RF power is obtained, suspect the RF detector or A4 assembly. Check the A4TP5 voltages listed in Table 8-12 and the detector output voltage listed in Table 8-11.

If there is still no RF power with A4 removed, reinstall the A4 assembly. Force A4TP5 alternately high and low as described above, and check the voltage at A2A1TP5 against the values given in Table 8-12.

- If A2A1TP5 stays near 0 Vdc, the modulator diode is probably shorted. However, before replacing any microcircuit, always check the power level directly into and out of the assembly to ensure that the problem is isolated to that particular assembly.
- Force A4TP5 low (-1.2 Vdc) as described above. This should turn A2A1Q3 off allowing both A2A1TP5 and the collector of A2A1Q3 to float to approximately +9.5 Vdc. If A2A1TP5 stays near 0Vdc, the modulator is probably shorted.

If A2A1Q3 and the modulator are functioning properly, but RF power is still missing or low, check the following RF levels with a power meter or spectrum analyzer. When checking power levels internal to the RF signal path, ensure that all critical ports are terminated in 50 ohms.

- If power is minimal, check the RF level directly out of the A9 YO. The minimum level from this assembly should measure +13 dBm.
- Check the RF levels around A2 doubler with no modulation (i.e. remove the A4 assembly). Unleveled power from the A2A2 microcircuit should reach about +11 dBm. If the problem appears to be the microcircuit or the A2A1 pulse assembly, refer to the A2 service section.

FULL UNLEVELED RF POWER

If maximum unleveled RF Power is observed, attempt to achieve minimum RF power out by forcing A4TP5 to +8.9 Vdc as described above. A2A1TP5 should read approximately -0.9 Vdc.

- If the voltage at A2A1TP5 is approximately -0.9 Vdc, the modulator diode is probably open. However, be sure to check for open contacts between the A2A1 pulse assembly and A2 microcircuit before replacing the two assemblies (they are not separately replaceable).
- If A2A1TP5 reads 0 Vdc, the modulator diode is probably shorted.
- If A2A1TP5 reads about +9.5 Vdc, A2A1Q3 is probably open.

A4 Automatic Leveling Control (ALC) Circuit Description

INTRODUCTION

The A4 automatic leveling control (ALC) assembly is part of a closed loop power leveling function, designed to control the amplitude of the RF output power. The **GENERAL OPERATION** section below describes loop operation, including some components external to the A4 assembly. The rest of this operational theory is devoted to detailed description of the circuits found on the A4 assembly.

GENERAL OPERATION

The circuits which accomplish power control and power leveling can be divided into two categories: internal loop circuitry and external components of the loop. Figure 8-30, *Simplified ALC Block Diagram*, illustrates this.

The power level reference leg of the ALC establishes the power level selected by the operator. This is accomplished by pressing the RF plug-in **[POWER LEVEL]** pushbutton and rotating the RPG or entering the desired reference on the HP 8350 front panel data entry keys. This leg of the ALC is not an interdependent part of the loop, as shown in Figure 8-30.

The detector leg of the ALC loop samples the actual RF output power and produces a voltage proportional to RF amplitude. This voltage is converted to log scale and compared with the power level reference signal. If the voltages at the summing junction are not of equal magnitude, an error voltage is generated. This error voltage is amplified and converted to a current drive for the RF modulators, which vary the transmitted RF power to correct the error and achieve the desired RF power level.

ADDRESS DECODER AND CONTROL LATCHES, BLOCK A

A4U12 is a 3-to-8 decoder, selecting address 2C07H, when it is present on the address bus. This address serves as a chip enable for octal latch A4U13. Information on the data bus is then latched into A4U13 and used throughout the A4 assembly. A4U14 and A4U15 have been added to provide the proper outputs for all three ALC leveling modes.

DETECTOR INPUTS AND SELECTION SWITCHES, BLOCK B

Control lines MUX A0B and MUX A1B are encoded with leveling mode information. The lines are decoded in Table 8-13. A4U6 decodes these control lines to select the proper detector input for the desired operating mode.

Table 8-13. Leveling Control Lines

DATA BUS					Leveling Mode
Mux AO	Mux A1	Mux A0B	Mux A1B	PM	
H	H	H	H	L	INT 0 (not valid)
L	H	L	H	L	INT 1
H	L	H	L	L	EXT
L	L	H	H	H	PM 0 (not valid)
L	L	L	H	H	PM 1

EXT/MTR ALC input provides external crystal leveling capability within the -10 to -200 mV range and power meter leveling capability within the 0 to $+1V$ range. A4VR4 and A4VR5 provide protection against transients. Two Schottky diodes, A4CR1 and A4CR2, are mounted between the EXT/MTR ALC connector and the front panel casting for similar protection.

When [MTR] (power meter) leveling is selected, the power meter (HP 436A) is used in conjunction with the internal leveling detector. U1A routes the power meter signal to a separate power meter log amplifier. The internal leveling detector is routed through A4U6B and the input sample and hold to the main log amplifier. The internal leveling detector compensates for the response of the power meter and prevents instability while at the same time permitting reasonable sweep times.

SAMPLE AND HOLD DRIVERS, BLOCK K

Q10 and Q11 act as complementary pairs, controlling the input sample and hold, and error sample and hold circuits respectively. The complementary pairs improve action of the sampling FETs A4Q5 and A4Q6 by reducing the error signal passed through gate to source capacitance. The sample and hold function of the ALC loop is used in conjunction with pulse modulation. When L PULSE ENABLE is high, and L PULSE is low, A4Q10A and A4Q11B turn on, causing A4Q10B and A4Q11A to turn off, thereby initializing the HOLD mode.

The frequency of the sampling mode is dependent on the L PULSE input. When the system is used with the HP 8756A or 8757A scalar network analyzer, the L PULSE input is a 27.8 kHz square wave, controlling the gates of A4Q5 (Block I) and A4Q6 (Block E). The sample level is maintained during the OFF pulse, thus preventing saturation of the log and main ALC amplifiers.

INPUT SAMPLE AND HOLD, BLOCK E

The input sample and hold function prevents the log amplifier from saturating during pulse modulation.

A4U16 is a unity gain follower with internal feedback which buffers the detector input. A4R78 compensates for the offset voltage of the operational amplifier. A4Q6 and A4C21 perform the sample and hold function.

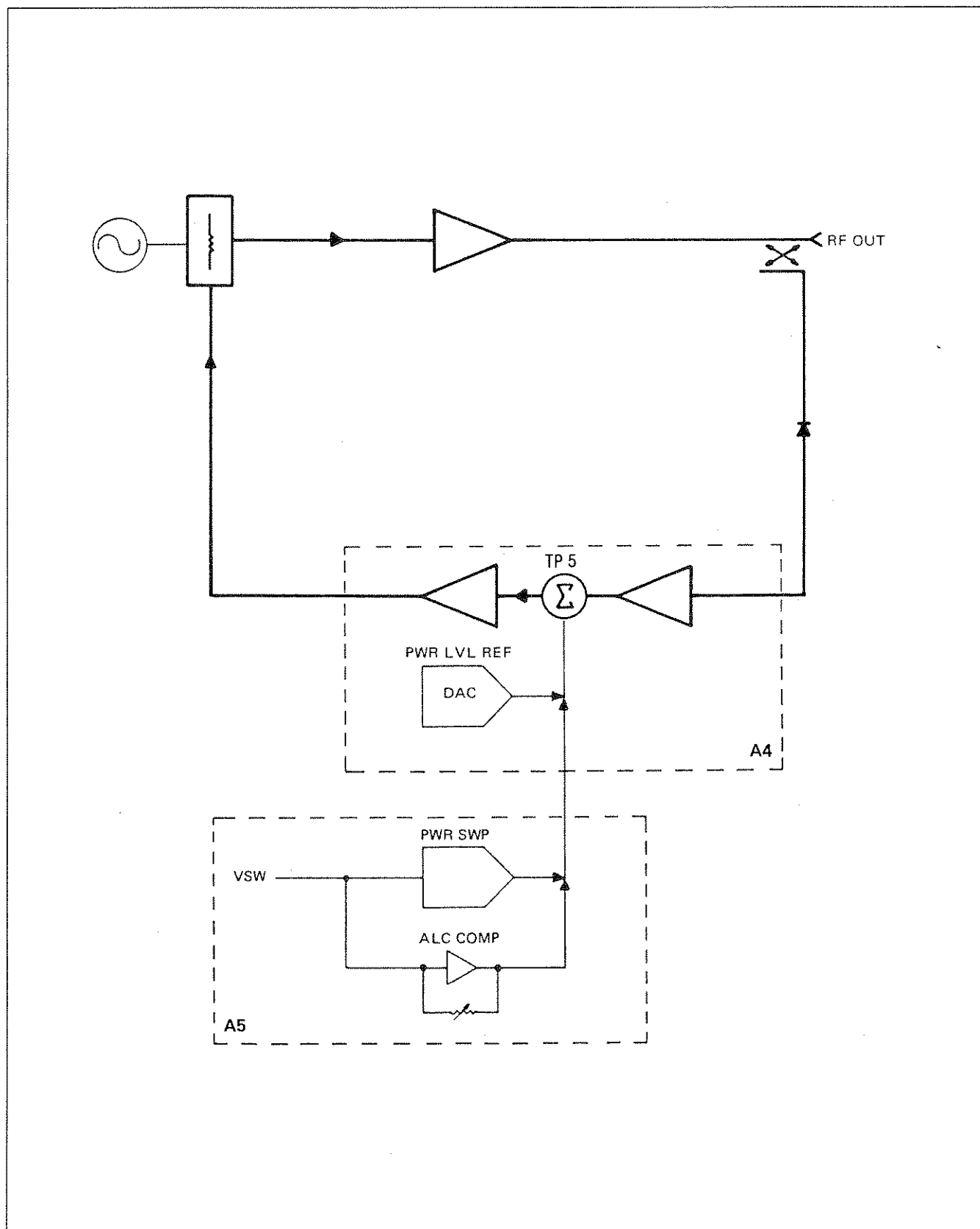

Figure 8-30. Simplified ALC Block Diagram

POWER METER LOG AMPLIFIER, BLOCK F

The power meter log amplifier is used in conjunction with the log amplifier in ALC mode [MTR]. The power meter log amplifier sets the power level and takes care of low frequency variations. The log amplifier (Block G) takes care of the high frequency variations.

A4U5B is a unity gain follower which buffers the input of A4U5D. Logarithmic scaling is performed by A4Q3A in the feed back loop of A4U5D. The base-emitter voltage of A4Q3A is exponentially related to its collector current, hence the logarithmic action of the amplifier. A4Q3B compensates the log amp over temperature. A4U5A is a standard non-inverting amplifier, with its gain controlled by A4R33 and A4R32. A4CR3 prevents oscillation in the log amplifier.

LOG AMPLIFIER, BLOCK G

The logarithmic scaling function is performed by A4Q9A in the feedback loop of A4U17. A4Q9A collector current is proportional to the voltage at TP10 and exponentially related to its base-emitter voltage. Therefore, A4Q9A emitter voltage is logarithmically related to the input voltage at TP10.

A4Q9B compensates the log amp against changes in reverse saturation current with temperature.

A4CR9 clamps the output of A4U18 to 0.6V above the input voltage to A4U17, preventing oscillations.

A4U6A decodes MUX A0B and MUX A1B (Table 8-13) to select the proper offset voltage for power calibration at the low end of the plug-in power range. In EXTERNAL ALC, the power level calibration is set with the front panel EXT CAL potentiometer.

A4U18 amplifies the logged output for comparison with the power level summing signal (Block H). A4R10 adjusts the gain of A4U18, and calibrates midrange power levels.

Guarded-gate FETs A4Q7, A4Q8, and A4Q16 select the appropriate detector return for INTERNAL EXTERNAL, and PM (power meter) leveling.

POWER LEVEL REFERENCE, BLOCK C

POWER LEVEL SUMMING, BLOCK H

A4U11 is a 12-bit microprocessor-compatible digital to analog converter (DAC), which latches data in three 4-bit bytes. The $-10V$ REF input sets the DAC for maximum output (TP2) or $+10V$. The voltage at TP2 is the product of $-10V$ REF and the fractional binary input of the DAC.

The voltage at TP1 is the sum of several voltages, depending on the operating mode of the plug-in. A4U2A sums PWR SWP/COMP and AM inputs. In addition, variable feedback resistor A4R8 reduces gain to compensate for detector deviation from square-law at the upper limits of the plug-in power range.

The EXT CAL and FREQ TRK V inputs are summed through amplifier A4U2C. A4R30, in the feed back loop of A4U2C, provides temperature compensation for the log Amplifier and detectors.

ERROR, SAMPLE AND HOLD, BLOCK I

The error, sample and hold function prevents the main ALC amplifier from saturating during pulse modulation.

A4U2D pin 10 is the summing junction for the power level summing output and log amplifier output.

Under leveled power conditions, the voltage at A4U2D pin 10 is zero. A non-zero voltage represents an error and forces a change in modulator current until power is leveled.

A4U2D buffers the error voltage. A4Q5 and integrating circuit A4U9 perform the sample and hold. A4C7 eliminates error due to the gate to source capacitance of A4Q5.

LOG AMPLIFIER SELECTOR, BLOCK J

The log amplifier selector circuit selects a through path for the log amplifier, or combines its output with that of the power meter log amplifier (MTR). In MTR, A4R84 and A4C3 act as a high pass filter, to shape the output of the log amplifier, which is then combined with the power meter log amplifier output. The combination of the two prevents instability when using certain power meters.

In switch A4U4: A and B are open, C is closed in INT or EXT DET mode. The opposite is true in MTR mode.

MAIN ALC AMP, BLOCK L UNLEVELED SIGNAL, BLOCK M

Both inputs to integrator A4U9 are at virtual ground under leveled power conditions, allowing for immediate response to an input error voltage.

A4R15 optimizes the speed at which the loop responds to power level changes.

When [RF BLANK] is selected on the HP 8350, L RFB goes low during retrace and A4U1D closes, pulling current through A4C4, forcing TP5 high and turning on the modulator.

A4C4 compensates for the response time of the ALC loop during power meter leveling to prevent oscillations.

A4CR6 and A4CR13 reduce the capacitive loading of the integrator introduced by A4VR2.

Under unleveled conditions, A4VR2, A4CR6, and A4CR13 will clamp the output of U9 at approximately -1.2 and $+8.9$ volts, preventing negative or positive saturation. Under leveled power conditions, the output of A4U9 should measure approximately $+0.6$ to $+2V$. When the output of A4U9 dips below -0.6 volts, comparator U10 activates the front panel LED indicating unleveled power.

The MOD DRIVE voltage is converted to a current source to drive the modulator in the microcircuit package. This voltage-to-current converter is found on the A2A1 assembly, attached to the A2 microcircuit.

Table 8-13a. Connector Pin Descriptions

A4P1				
PIN	SIGNAL	I/O	TO/FROM	BLOCK
1	EXT DET RET	IN	A8J2	P
23	EXT DET	IN	A8J2	B
2	LUNLVL	OUT	A6P1-40, A7P1-29	M
24	EXT CAL	IN	A8J1-12	H
3	PWR REF		Not Used	C
25	FREQ TRK V	IN	A7P1-41	F
4	AM	IN	P1-A4	C
26			Not Used	
5	PWRSW/COMP	IN	A5P1-23	C
27	+5V	IN	A3P1-6, 7	P
6	-40V	IN	P1-11	P
28	-15V	IN	P2-28	P
7	+10V	IN	P1-8	P
29	LRFB	IN	P2-56	L
8	GND DIG			P
30	GND DIG			P
9	BD1	IN	A3P1-9	A,C
31	BD0	IN	A3P1-31	A,C
10	BD3	IN	A3P1-10	A,C
32	BD2	IN	A3P1-32	A,C
11	BA1	IN	A3P1-11	A,C
33	BA0	IN	A3P1-33	A,C
12	BA3	IN	A3P1-12	A,C
34	BA2	IN	A3P1-34	A,C
13	BD5	IN	A3P1-13	A
35	BD4	IN	A3P1-35	A
14	BD7	IN	A3P1-14	A
36	BD6	IN	A3P1-36	A
15	GND ANLG			P
37	GND ANLG			P
16	+20V		Not Used	
38	+15V	IN	P2-29	P
17	-10V	IN	P1-13	P
39	-40V	IN	P1-11	P
18	LINST1	IN	A3P1-8	A,C
40			Not Used	
19	LPULSE	IN	Not Used	
41			A7P1-23	K
20	INT DET1	IN	A2A1J3-2	B
42	INT DET RET	IN	A2A1J3-9	P
21	-10V REF	IN	Not Used	
43			A6P1-5	C
22	MOD DRIVE	OUT	A2A1J3-11	L
44			Not Used	

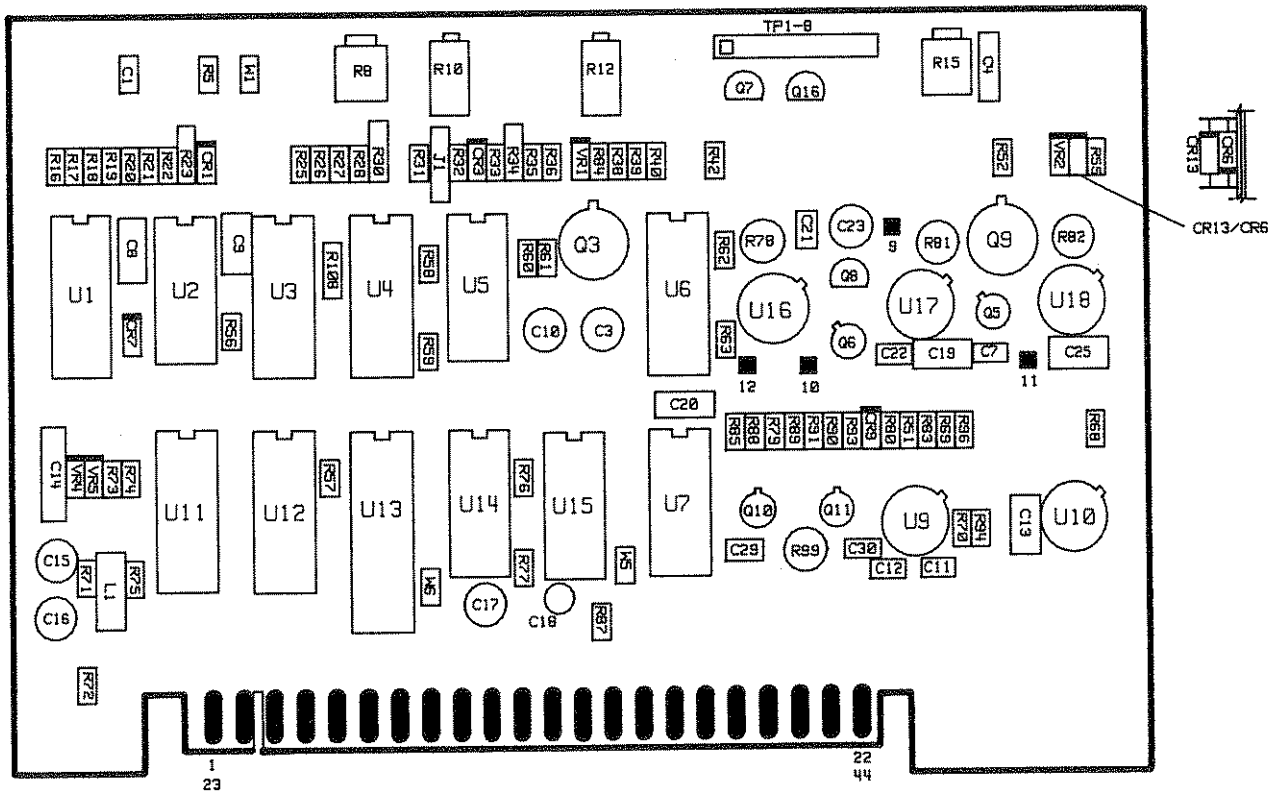
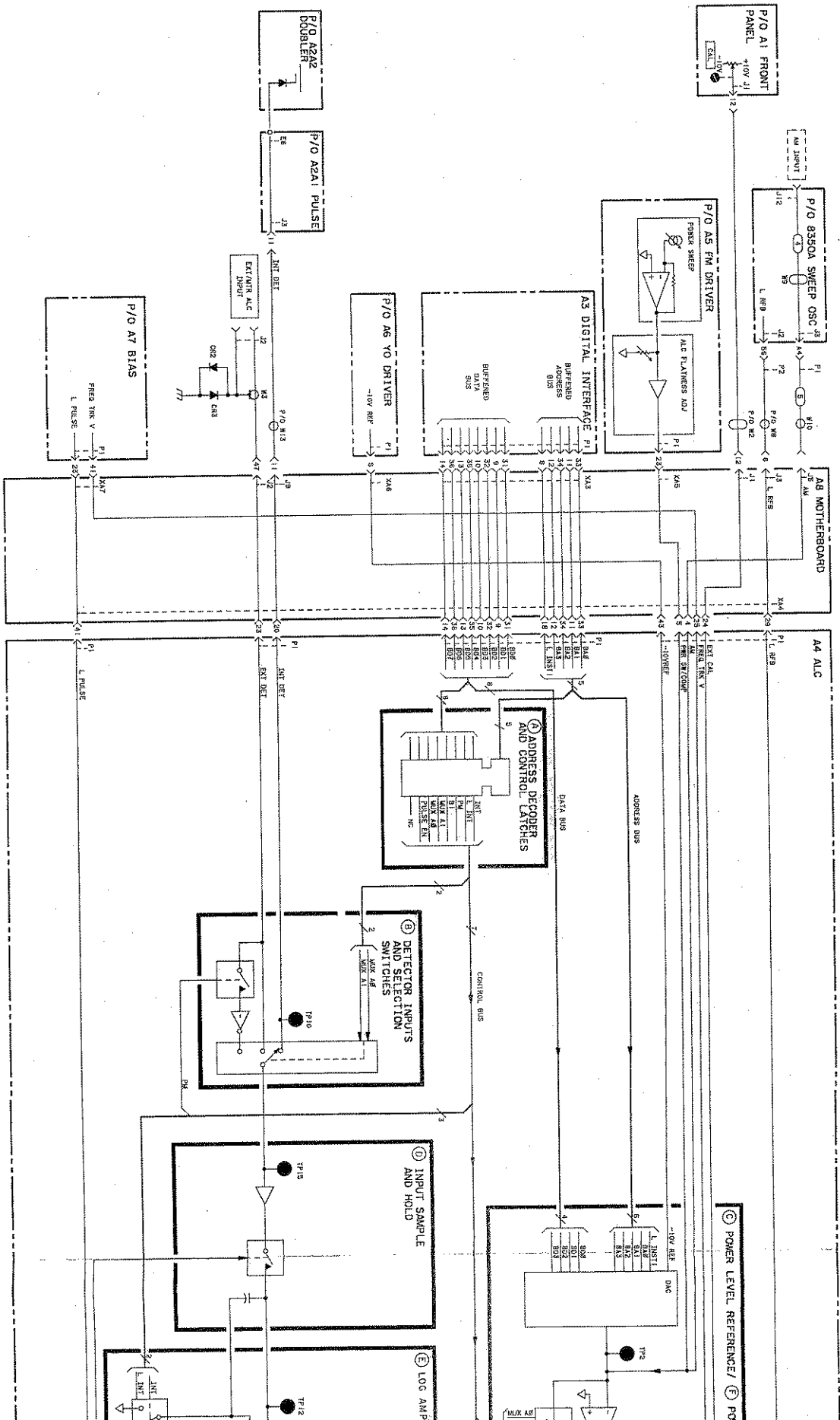

Figure 8-31. A4 ALC Component Locations

5

6

7



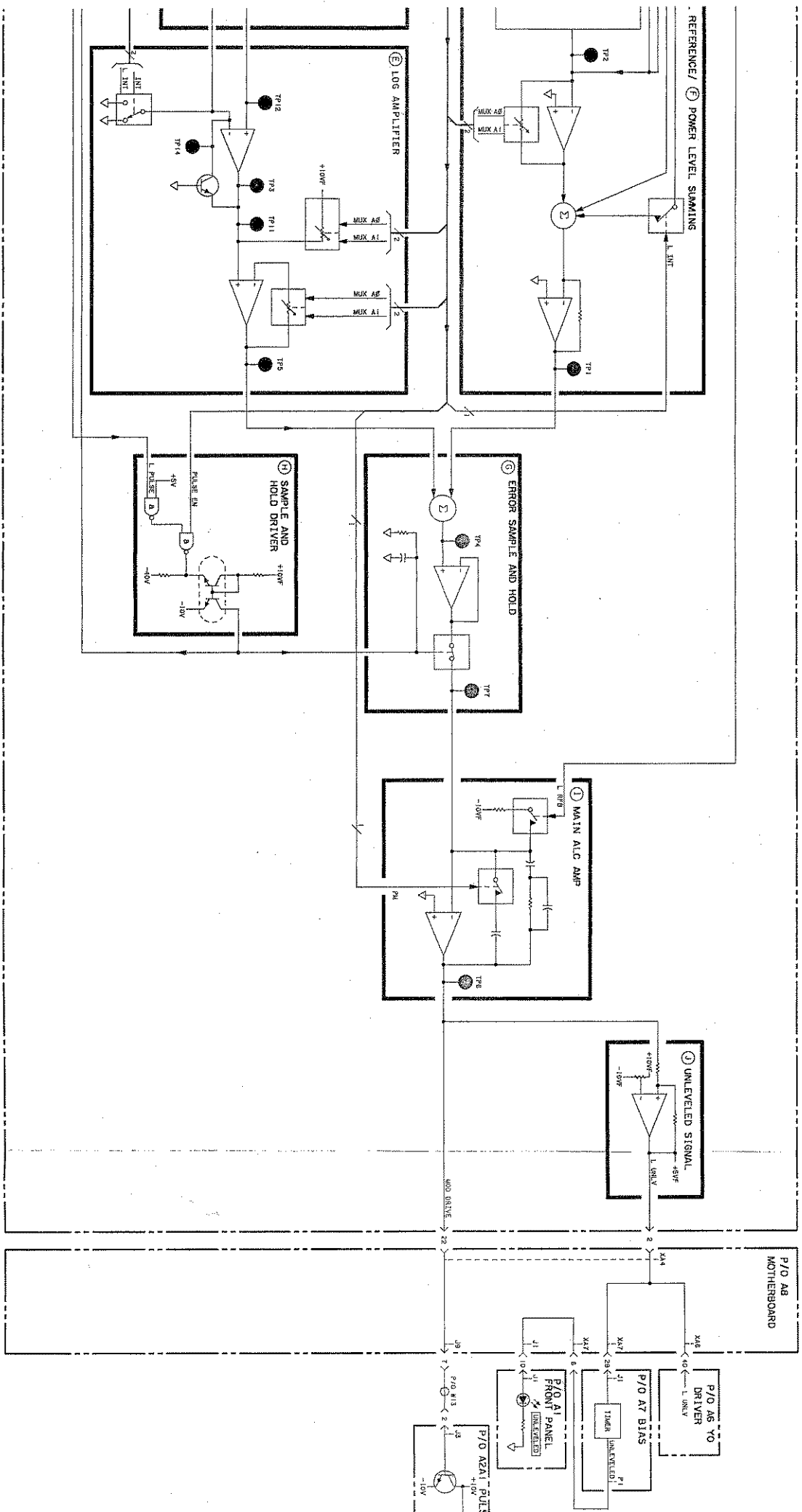

Figure 8-32. A4

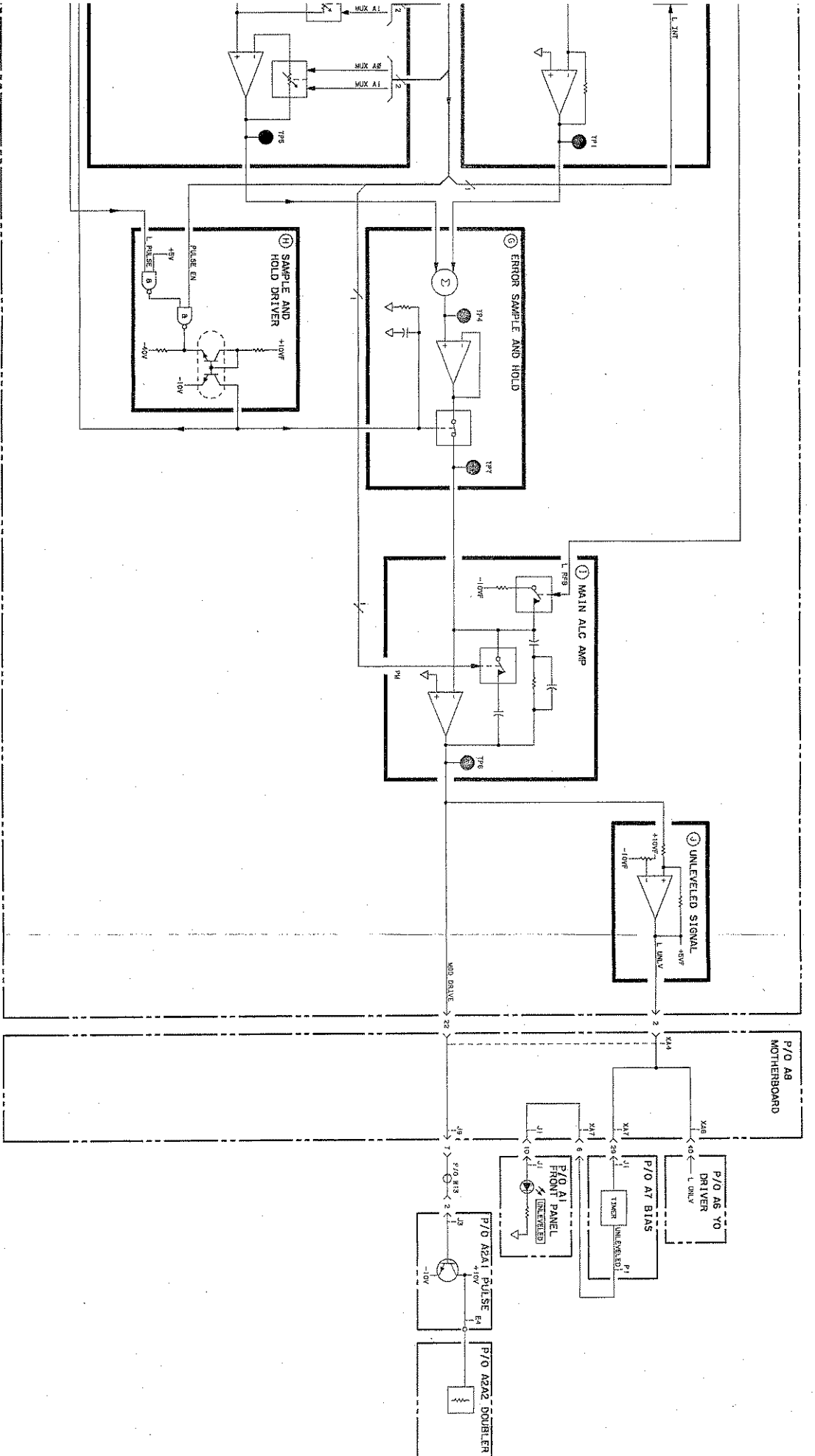
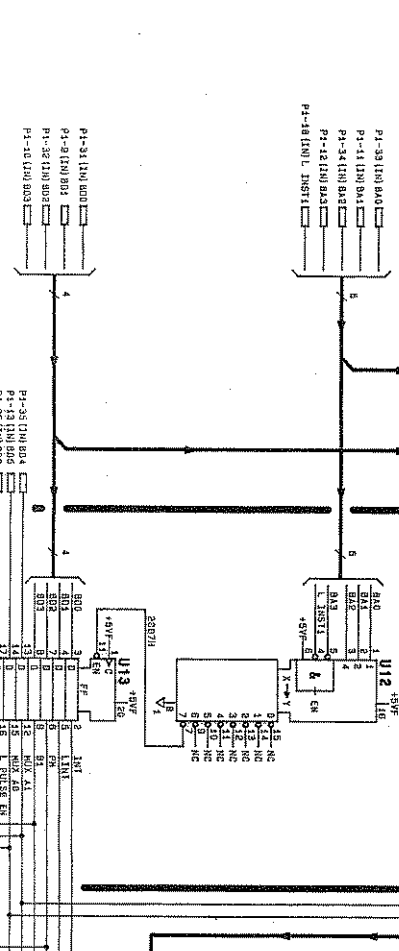

Figure 6-32. A4 ALC, Overall Block Diagram
8-87/8-88

A4 ALC
83570-60077

① ADDRESS DECODER AND CONTROL LATCHES



② POWER LEVEL REFERENCE

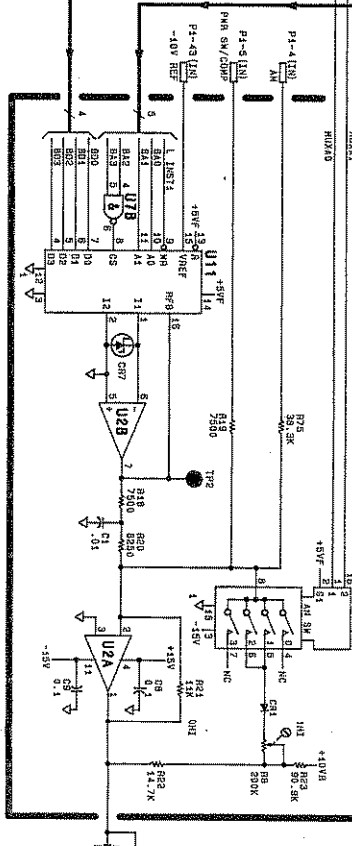

③ +10V REFERENCE

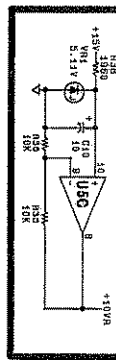

④ POWER METER LOG AMPLIFIER

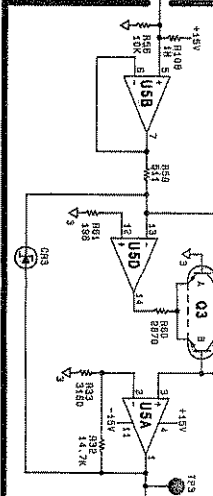

⑤ LOG AMPLIFIER

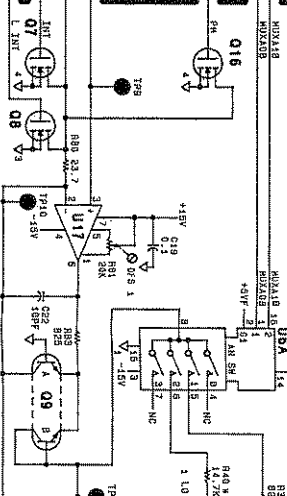

⑥ INPUT SAMPLE AND HOLD

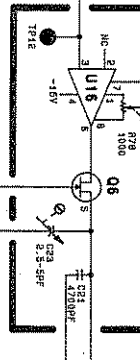

⑦ DETECTOR INPUTS AND SELECTION SWITCHES

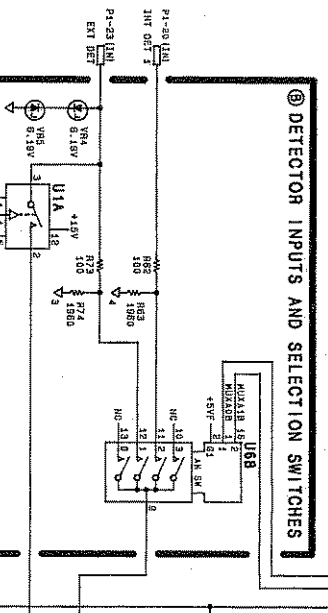

⑧ SUPPLY FILTERING

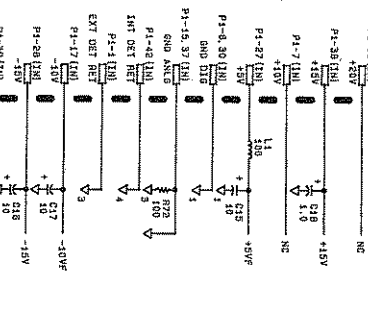

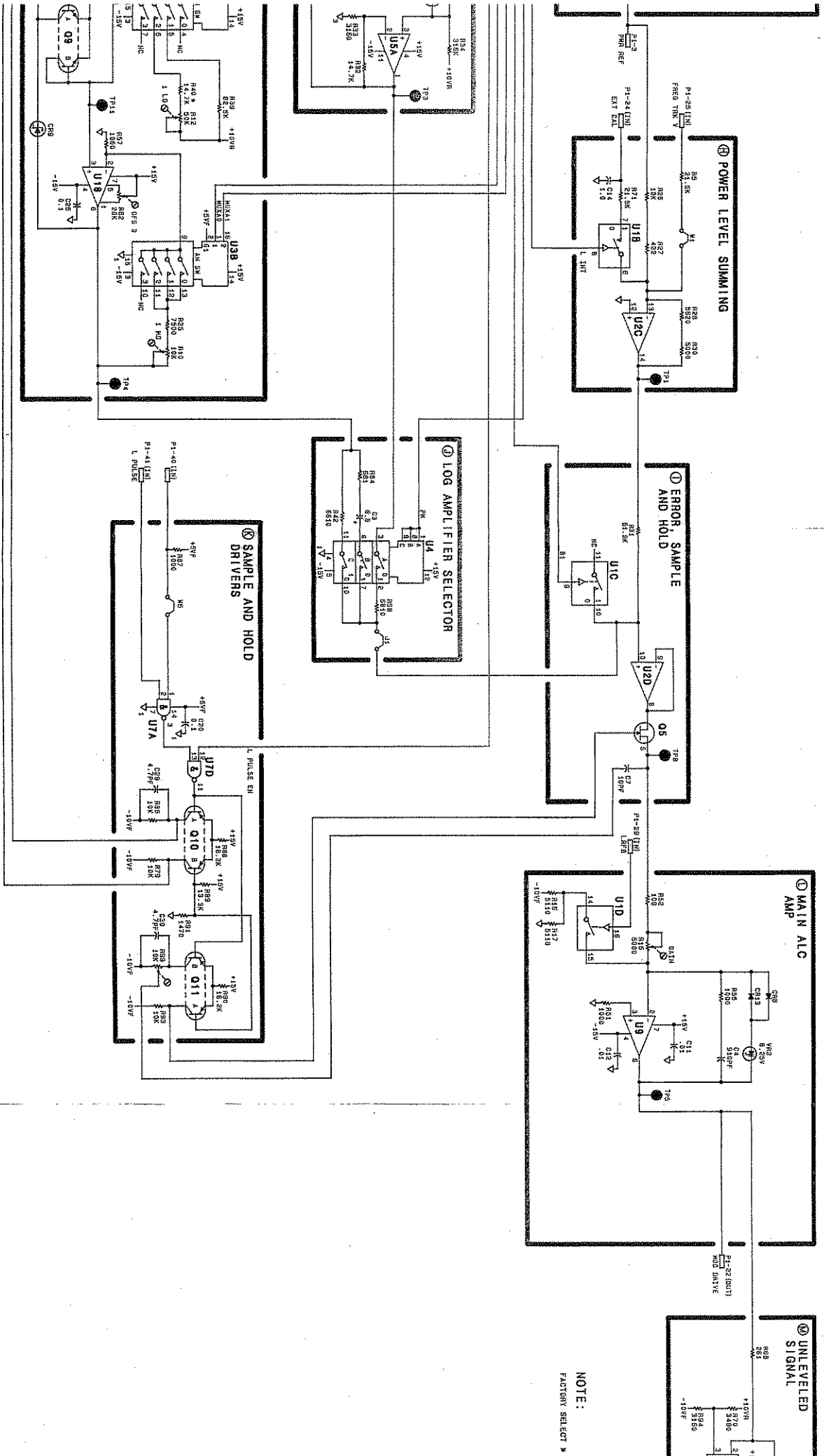

NOTE:
FACTORY SELECT *

Figure 8

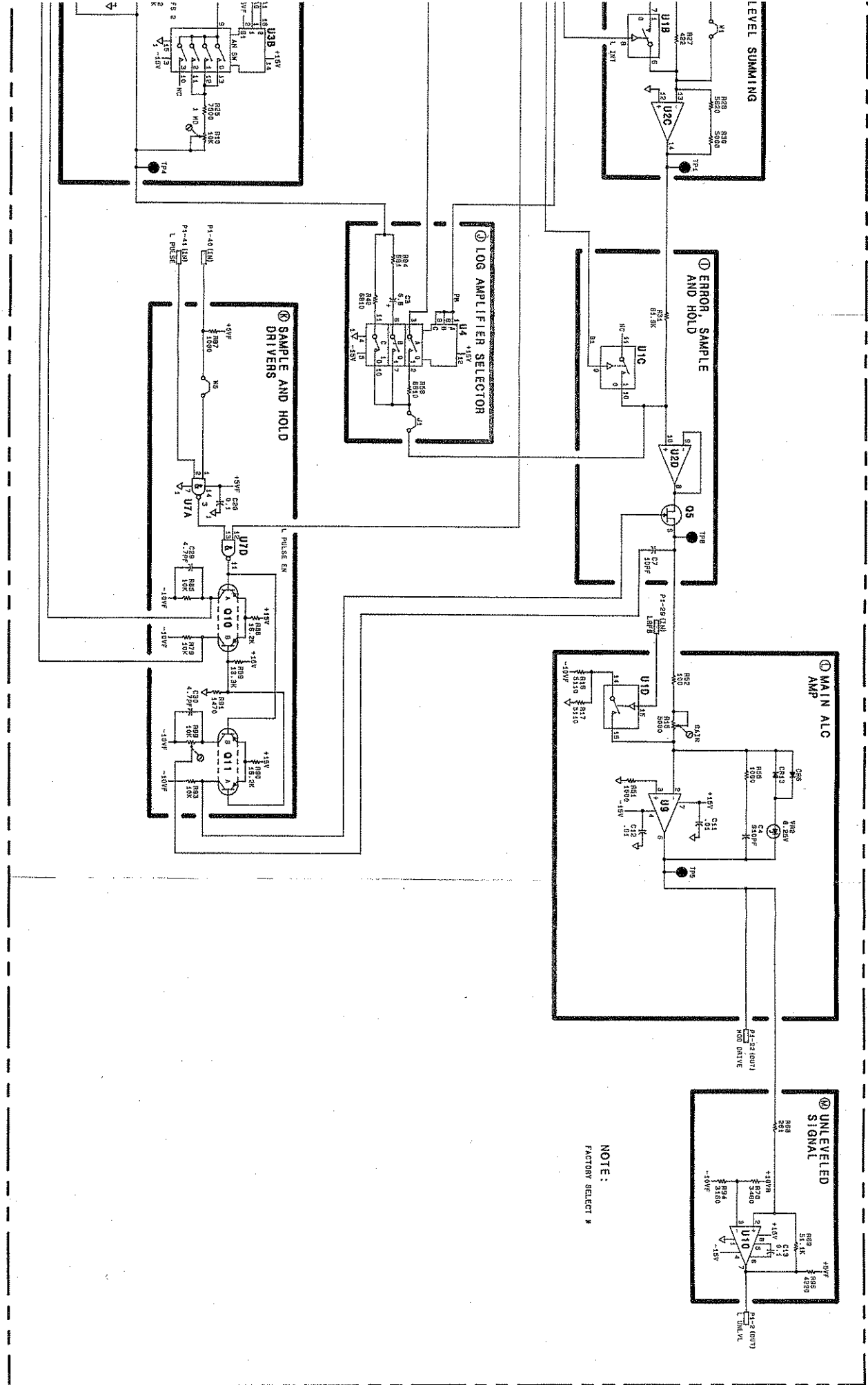

NOTE:
FACTORY SELECT #

Figure 6-33. A4 ALC Schematic Diagram
R-89/8-90

A5 FM Driver Troubleshooting

INTRODUCTION

For troubleshooting purposes, the A5 FM Driver is divided into three groups:

- YIG Main Coil FM Driver and YIG FM Coil Driver circuits.
- FM Configuration Control circuits.
- Power Sweep and ALC Flatness Adjustment circuits.

YIG MAIN COIL FM DRIVER AND YIG FM COIL DRIVER TROUBLESHOOTING

The most likely indication of a failure in these circuits is unpredictable or no FM operation. A failure in these circuits can also cause excessive residual FM or frequency offset.

Troubleshooting waveforms at various points within the FM driver circuits for FM input frequencies of 100 Hz, 700 Hz, 1 MHz, and 10 MHz are given in Figure 8-37. The waveforms are arranged horizontally by test point and vertically by the FM input frequency. Figure 8-34 shows the test setup required to obtain the waveforms.

NOTE: Before altering the switch settings on A3S1, write down the present configuration. Return the switches to their original status after troubleshooting.

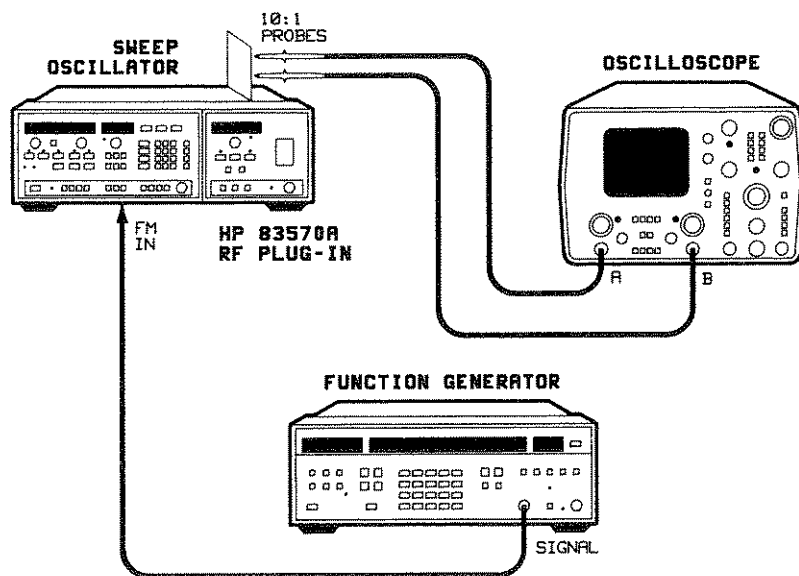

Figure 8-34. A5 Troubleshooting Test Setup

Prior to performing the test procedure, preset the A3S1 Configuration switch sections 5 and 6 to the closed (0) position. Several of the troubleshooting waveforms require different switch settings. A description of each switch setting follows:

- For **-6 MHz Sensitivity**, set A3S1-5 to the open (1) position.
- For **-20 MHz/V Sensitivity**, set A3S1-5 to the closed (0) position.
- For **DC Coupled Mode**, set A3S1-6 to the open (1) position.
- For **Cross-Over Coupled Mode**, set A3S1-6 to the closed (0) position.

NOTE: The HP 8350 front panel **[INSTR PRESET]** pushbutton must be pressed after each switch position change in order for the selection mode to take effect.

1. Adjust the function generator frequency and amplitude controls to obtain one of the waveforms in the first column (TP11) of Figure 8-37.
2. Verify the remaining waveforms in the corresponding row.

FM CONFIGURATION CONTROL CIRCUITS TROUBLESHOOTING

The FM configuration control circuits include the address decoder, control latches, relays K1 and K2, and analog switches U3D and U11. Incorrect or no operation in a specific configuration mode is the most likely results of a failure in these circuits. The troubleshooting procedure for these circuits used several of the HP 8350 sweep oscillator operator initiated self tests. Separate tests for each section of the configuration control circuits are provided in the following paragraphs.

Address Decoder

Check proper address decoder operation by performing a minor address decoder self test.

On the HP 8350, enter:

[SHIFT] [5] [4] Minor Address Decoder Test

Check the Address Decoder outputs LEN4 and LEN 5 as shown in Figure 8-35.

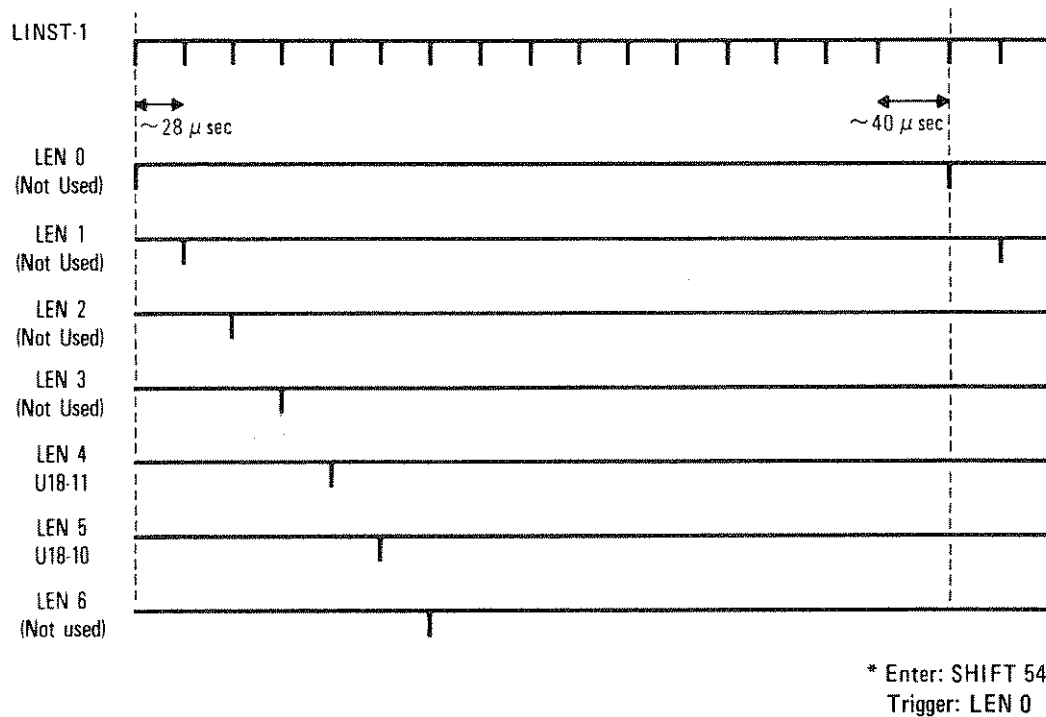

Figure 8-35. A5 Decoder Timing Diagrams*

Control Latches

Control latch U16 is checked by performing a hexadecimal data rotation write to U16, and then checking the outputs for the waveforms shown in Figure 8-2. The oscilloscope should be triggered from U16 pin 15.

Exercise U16 with Hex Data Rotation Write. Enter:

[SHIFT] [0] [0] [2] [GHz s] [0] [4] [M4]	Enters Hex Data command Address location 2C04 (U16) Hex Data Rotation Write
--	---

Check the outputs of U16 against waveforms shown in Figure 8-2.

Relays K1 and K2

A known FM input is applied and the waveform at TP4 is monitored. The Hex Data Write feature of the HP 8350 is used to control relays K1 and K2. Connect equipment as shown in Figure 8-34. Adjust the function generator for a 500 Hz 1V peak-to-peak output with a +0.5 Vdc offset (use function generator offset control).

To check relay K2, enter on the HP 8350:

[SHIFT] [0] [0] [2] [GHz s] [0] [4] [M2] [.] [8]	Enters Hex Data command Address location 2C04 (U16) Hex Data Write A8
--	---

Relay K1 should be open. Verify that the signal at TP4 is offset from being centered around 0VDC.

On the HP 8350, enter:

[M2] [8] [8] Hex Data Write 88

Relay K1 should now be closed. Verify that there is a signal centered around 0VDC at TP4.

To check relay K2, enter on the HP 8350:

[M2] [BK SP] [8] Hex Data Write E8

Relay K2 should now be closed. Note the level of the signals at TP3 and TP4.

Open relay K2 by entering on the HP 8350:

[M2] [dBm dB] [0] Hex Data Write F8

Relay K2 should now be open. Verify that the level of the signals at TP3 and TP4 is less than previously noted.

Analog Switches U3D and U11

The analog switches are checked by using the Hex Data Write feature of the HP 8350 to control the switches. A known FM input is applied and switch operation is verified.

Connect equipment as shown in Figure 8-34. Adjust the function generator for a 500 Hz 1V peak-to-peak output.

On the HP 8350, enter:

[SHIFT] [0] [0] [2] [GHz] [0] [4] [M2] [dBm dB] [8]	Enters the Hex Data Command Address location 2C04 (U16) Hex Data Write E8
--	---

Analog switch U3D should be closed. Verify a signal at TP3.

On the HP 8350, enter:

[M2] [dBm dB] [8] Hex Data Write E0

Analog switch U3D should be open. Verify that there is no signal at TP3.

On the HP 350, enter:

[M2] [dBm dB] [8] Hex Data Write E8

Analog switch U22 should be set to the zero position. Verify that a signal is present at TP6.

On the HP 8350, enter:

[M2] [dBm dB] [GHz s] Hex Data Write EC

Analog switch U11 should be set to the one position. Verify that no signal is present at TP6.

POWER SWEEP/ALC ADJUSTMENTS TROUBLESHOOTING

The most likely indication of a failure in these circuits is either incorrect or no operation of the power sweep function or inability to adjust the output power flatness. The power sweep DAC U17 is exercised by initiating the Power Sweep DAC self test, and the DAC output is checked at TP8. On the HP 8350, enter:

[CW] [SHIFT] [5] [1] Initiate Power Sweep DAC self test

Verify the waveform at TP8 corresponds with the waveform in Figure 8-36.

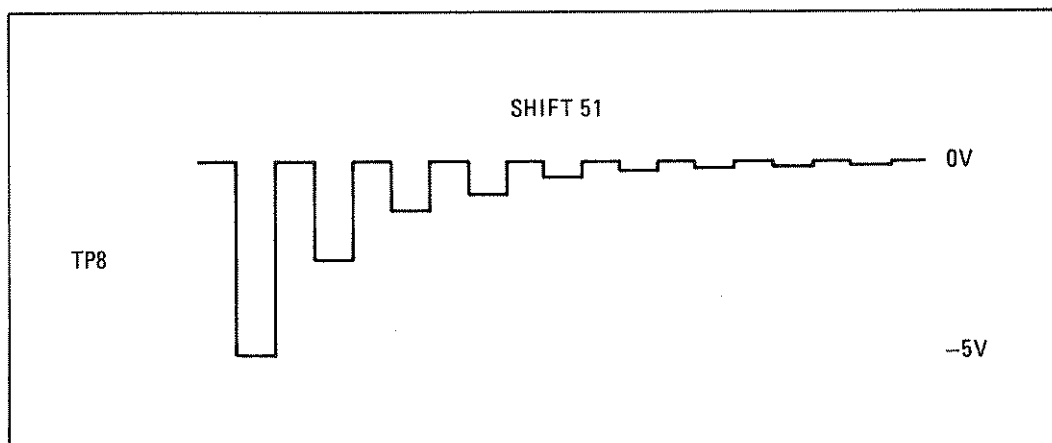
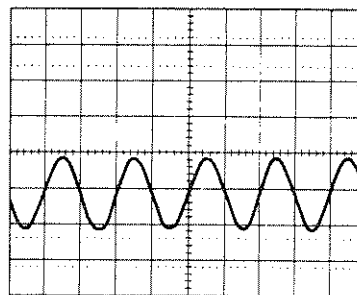
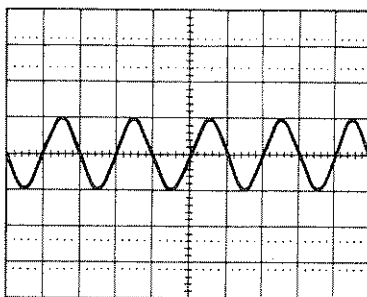

Figure 8-36. Power Sweep DAC Self Test Waveform

TP11
Cross-Over Coupled
-20 MHz/V

TP4
Direct Coupled

FM INPUT = 100 Hz
SCOPE = 5ms/DIV



FM INPUT = 700 Hz
SCOPE = 1ms/DIV

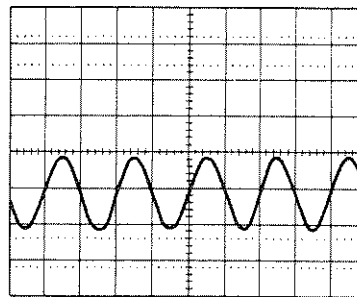
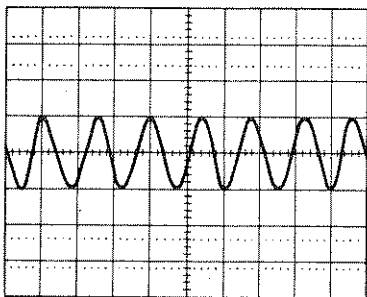

FM INPUT = 1 MHz
SCOPE = 0.5 μs/DIV

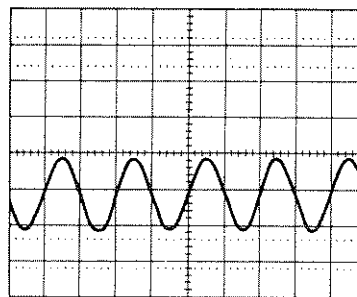
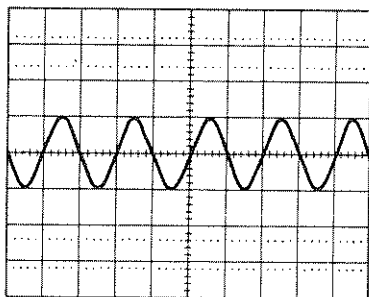
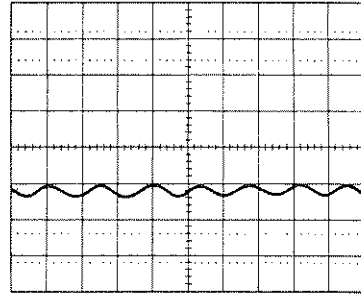
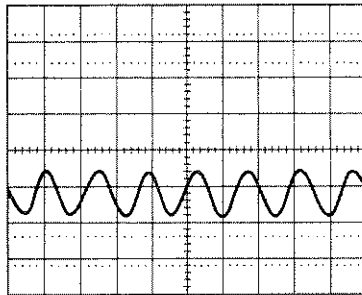

Figure 8-37a. Troubleshooting Waveforms

TP4
Cross-Over Coupled
-20 MHz/V

TP4
Cross-Over Coupled
-6 MHz/V

FM INPUT = 700 Hz
SCOPE = 1ms/DIV



FM INPUT = 1 MHz
SCOPE = 0.5 μ s/DIV

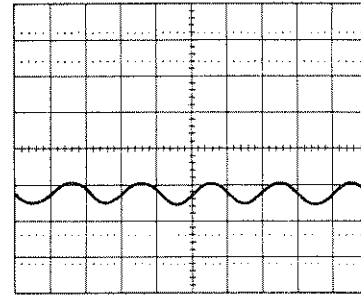
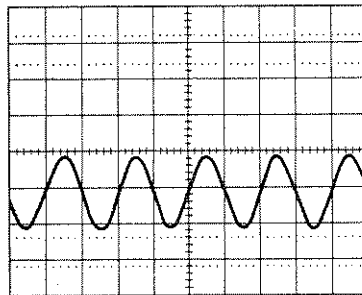

FM INPUT = 10MHz
SCOPE = 0.05 μ s/DIV

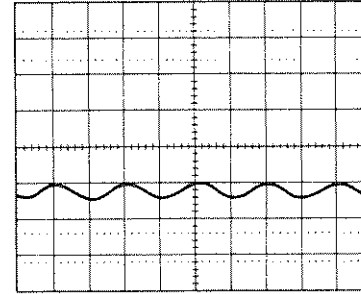
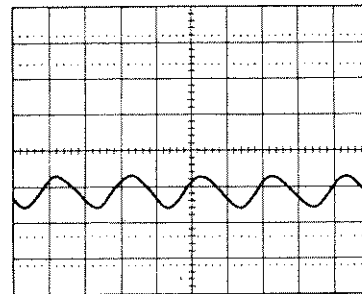
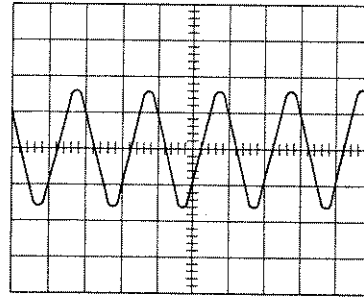
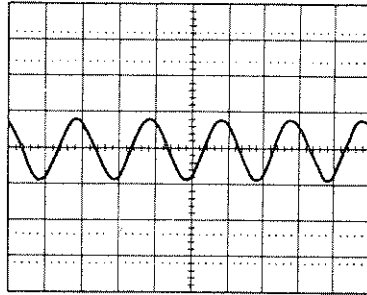

Figure 8-37b. Troubleshooting Waveforms

UR-7
Cross-Over Coupled
-20 MHz/V

TP3
Cross-Over Coupled
-20 MHz/V

FM INPUT = 100 Hz
SCOPE = 5ms/DIV



FM INPUT = 700 Hz
SCOPE = 1ms/DIV

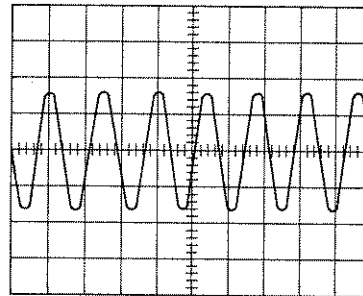
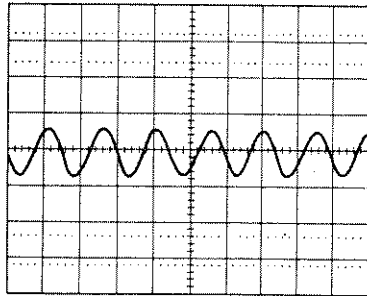

U10-6
Cross-Over Coupled
-20 MHz/V

TP6
Cross-Over Coupled
-20 MHz/V

FM INPUT = 1 MHz
SCOPE = 0.5 μs/DIV

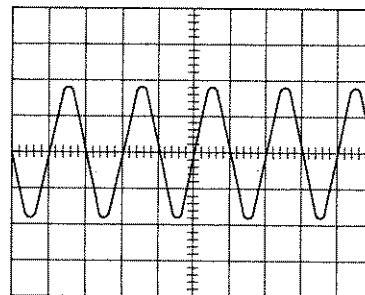
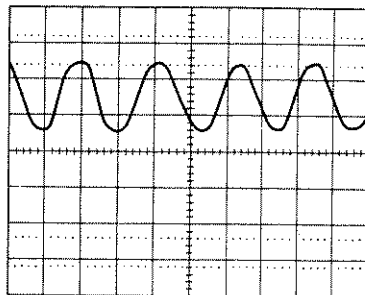
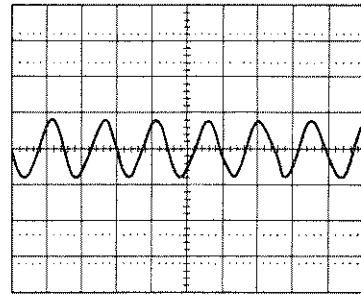
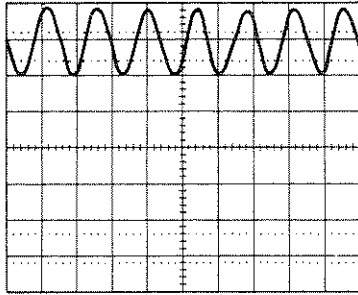

Figure 8-37c. Troubleshooting Waveforms

U10-6
Cross-Over Coupled
-20 MHz/V

TP6
Cross-Over Coupled
-20 MHz/V

FM INPUT = 700 Hz
SCOPE = 1ms/DIV



FM INPUT = 10MHz
SCOPE = 0.05 μs/DIV

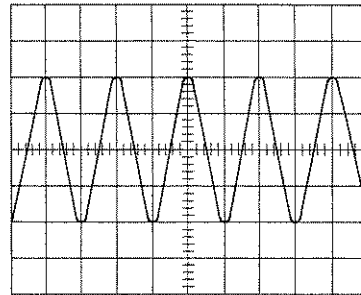
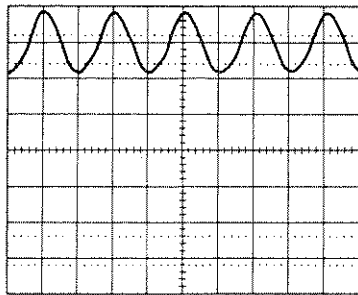
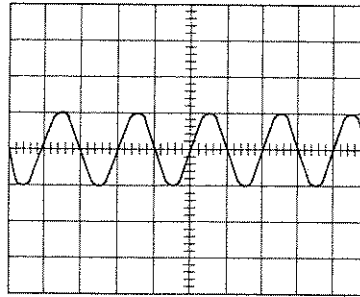

Figure 8-37d. Troubleshooting Waveforms

TP3
Cross-Over Coupled
-6 MHz/V

FM INPUT = 100 Hz
SCOPE = 5ms/DIV



FM INPUT = 700 Hz
SCOPE = 1 μ s/DIV

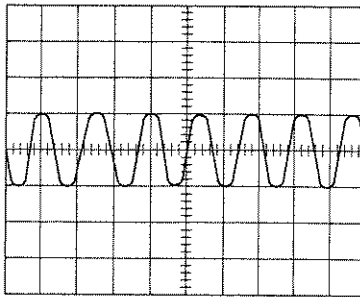

TP4
Direct Coupled

TP11
Cross-Over Coupled
-20 MHz/V

FM INPUT = 10MHz
SCOPE = 0.05 μ s/DIV

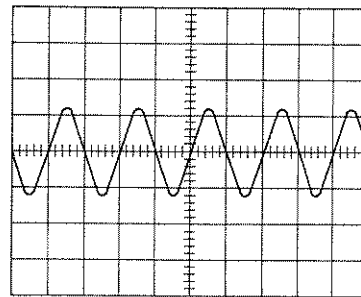
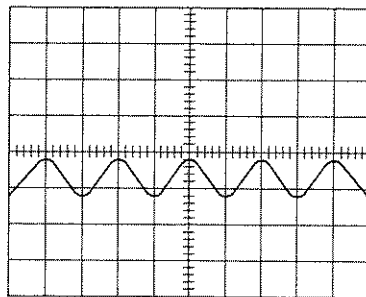

Figure 8-37e. Troubleshooting Waveforms

A5 FM Driver Circuit Description

INTRODUCTION

The A5 FM driver is divided into three major sections: The YIG main coil FM driver, the YIG FM coil driver, and the ALC flatness adjustments and power sweep circuits for the A4 ALC assembly.

The FM input signal from the rear panel of the HP 8350 sweep oscillator provides the input to both the YIG main coil and FM coil driver circuits.

If the FM input frequency is 700 Hz or less, the main coil driver scales and buffers the FM signal, producing an output that is summed with the tuning voltage. The summed signal is sent to the YIG coil current source on the A6 YO driver. Thus, the main coil driver output is an extra tuning voltage input to the YIG oscillator and may be used for phase locking, frequency offsetting, or low frequency FM applications. The main YIG tuning coil allows frequency deviations (from center frequency) of up to 75 MHz. This frequency deviation is much wider than that provided by the FM tuning coil (10 MHz), but the main coil is limited to low FM input frequencies.

If the FM input frequency is 700 Hz to 10 MHz, the FM coil driver scales and buffers the FM input signal to produce the current drive for the FM coil in the YIG oscillator. As mentioned above, the FM coil can handle higher FM input frequencies (than the main YO coil), but it can only deviate up to 10 MHz from center frequency. The main coil can deviate up to 75 MHz, but is limited to input frequencies of up to 100 Hz.

In DC coupled mode, FM signals are sent only to the FM coil driver circuit, regardless of input frequency.

Relay switches provide the option of selectable sensitivities of -6 or -20 MHz/Volt and/or DC coupling the FM input to the FM coil driver circuits. In the DC coupling mode, the main coil driver is shut off and the FM coil driver operates over the frequency range of DC to 10 MHz with -20 MHz/Volt sensitivity. The relay switches are controlled by the state of the configuration switch on the A3 digital interface assembly.

The ALC flatness adjustment circuit is used to flatten output power versus frequency by introducing an error voltage into the ALC reference channel. The power sweep circuit is activated by the front panel **[POWER SWEEP]** key. Power sweep produces a scaled ramp that is summed with the ALC reference voltage. The resultant signal causes the output power to increase as the sweep progresses (the amount of which is selected on the front panel).

YIG COIL FM DRIVER, BLOCK B AND E

The YIG main coil FM driver scales and buffers the HP 8350 rear panel FM input signal for FM frequencies between DC and 700 Hz. The output is summed with the YO main coil's tuning voltage on the A6 YO driver board. Low frequency amplifier/filter and low frequency sensitivity select circuits make up the YIG main coil FM driver.

A5R2 and A5C1 form a low pass filter that eliminates input signals much over 700 Hz. The signal coming out of the filter is buffered by difference amplifier A5U7A. The gain of A5U7A is about 0.61. The output of A5U7A drives the low frequency sensitivity select/amplifier circuits. Relay A5K2 is used to control the overall gain of inverting amplifier A5U7B by changing the input resistance. Relay A5K2 is either open or closed (shorting resistor A5R8) according to the status of control line 6MHz/V SEL is determined by the position of the configuration switch on the A3 digital interface board (the positions of the switch are described in Section III, Operation).

The overall gain for the main coil driver is about 0.05 with -6 MHz/Volt sensitivity selected (A5K2 open) and 0.19 with -20 MHz/Volt sensitivity selected (A5K2 closed). The output of A5U7B (TP3) is summed directly with main coil tuning voltage on the A6 YO driver board. The YIG main coil driver is shut off with analog switch A5U3D when the DC coupling mode is selected (on the A3 board configuration switch). When this mode is selected, the L LO FM OFF (Low = Low Frequency FM OFF) to be true.

YIG FM COIL DRIVER, D, F, AND H

The YIG FM coil driver scales and buffers the HP 8350 rear panel FM input above 700 Hz. The output current drives the FM YIG coil. The FM coil driver is made up of a high-pass filter, buffers A5Q5A and A5Q5B, video amplifier A5U10, operational amplifier A5U19, and unity gain follower A5U20.

The high pass filter is made up of A5C2 through A5C6, A5R11 and A5R12. The filter has a 3 dB cutoff frequency of about 700 Hz. When the FM driver is configured for the crossover mode (via the A3 configuration switch), the FM coil driver passes FM input signals from 700 Hz to 10 MHz. In the DC coupled mode, the main coil driver is shut off and control line L DC couple is true, activating relay K1. This shorts the high pass filter network, and the FM driver is active for input frequencies from DC to 10 MHz.

Selectable sensitivities of -6 MHz/Volt and -20 MHz/Volt are available. The sensitivity is determined by the A3 configuration switch. The configuration switch affects control line 6MHz/V SEL (1 = -6 MHz/V, 0 = -20 MHz/V). When 6MHz/V SEL is low, relay A5K2 is activated, shorting capacitors A5C4 through A5C6 and resistor A5R11. the combination of A5C2, A5C3, and A5R12 still form a high pass filter with a cutoff of 700 Hz. Note that in the DC coupled mode, the sensitivity is always -20 MHz/Volt.

The output of the filter network is limited to about + 3V with a network made up of A5VR1, A5VR2, A5R14, A5R15, A5CR3, and A5CR4. A5Q5A and A5Q5B are connected as emitter followers and buffer the output of the filter network to video amplifier A5U10. Analog switch A5U11 is always set to switch position zero. Frequency response shaping to compensate for the roll-off versus frequency of the FM coil is produced by the network made up of A5C11, A5C12, A5C14, A5R21, A5R22, A5R23, A5R75, and A5L1 connected across pins 9 and 4 of A5U10. This network is actually in the emitter of the input differential amplifier of A5U10 producing greater gain with decreasing impedance. Figure 8-38 shows the approximate response versus frequency of the YIG FM coil and the compensation network. Adjustments A5R19 (FM OFFSET), A5R75 (HI), and A5C14 (LO) adjust the shape of the compensation network response.

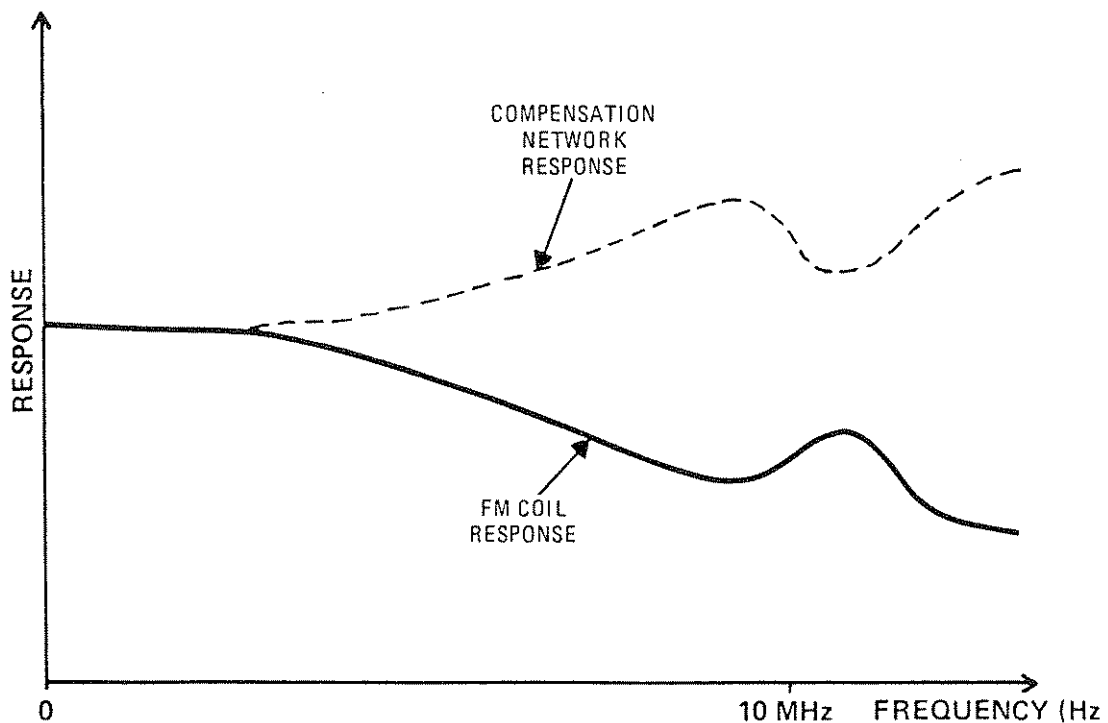

Figure 8-38. Plot of FM Coil Response Versus Frequency

The differential output of U10 drives the wideband output current driver, A5U19 and A5U20. The voltage difference between the outputs of A5U10 at pins 6 and 7 is converted to a proportional current which directly drives the YIG FM coil. The overall voltage gain of the output current driver is about 2.0 (between A5U10-6 and TP6). Resistive divider A5R30 through A5R32 sets the FM coil drive scale factor.

ADDRESS DECODER, BLOCK A

Address Decoder A5U18 generates two control lines (LEN 4 and LEN 5) by decoding the state of address lines BAO-3 and control line L INST 1. LEN 4 (Low Enable 4) loads data into the control latch and LEN 5 (Low Enable 5) loads data into the power sweep DAC.

CONTROL LATCHES, BLOCK C

Control latch, A5U16, stores the state of four control lines that are used to set the signal path and amplification factor of the FM input signal. The state of the control lines is determined by the position switches 5 and 6 of the configuration switch on the A3 digital interface assembly. The control lines are loaded into A5U16 from data bus lines BD2-BD5 when the LEN 4 signal from A5U18 makes a low to high transition.

ALC FLATNESS ADJUSTMENTS, BLOCK I

The purpose of the ALC flatness adjustment circuit is to produce an RF output signal that is as flat as possible across the entire frequency band. The input of the ALC flatness circuit is a 0 to 6 volt ramp (in full sweep) labeled **FREQ TRK V** (Frequency Tracking Voltage). This ramp is dependent on the frequency **START** and **STOP** settings, so it will always be at least a portion of the 0 to 6 volt range.

The **FREQ TRK V** ramp is applied to four parallel circuits, each one adjusted to take affect at a different frequency (i.e., voltage threshold of **FREQ TRK V**) as the sweep progresses from **START** to **STOP**. Since the four circuits are identical (A5Q1, A5Q2, A5Q3, and A5Q4) only the A5Q1 circuit will be discussed. A5Q1A is connected as a diode, is always conducting, and is in the circuit for temperature compensation of A5Q1B. The setting of adjustment BP1 (A5R34) determines at what point on the input ramp A5Q1B will conduct. When the summing point at the junction of A5U2C and A5R33 is at zero volts or greater, A5Q1B will conduct. The junction of resistors A5U1B and A5U1A form another summing point. A5U1B applies a positive-going ramp from A5Q1B to this summing point, and a negative-going ramp comes through A5U1A from the output of A5U14C. Slope adjustment SL1 adjusts the amount of negative-going ramp contributing to the summing junction through A5U1A, and thus determines the resultant contribution of the A5Q1 circuit to the input of A5U14A. That is, the resultant signal may be either a positive-going ramp or a negative-going ramp as required to make the RF OUTPUT signal flat over that frequency segment.

The composite correction signal from the four flatness adjustment circuits (A5Q1 through A5Q4) are summed at the input of A5U14A and then are applied to the power level reference in the ALC circuit. This composite correction signal can be found on TP1. Overall tilt is adjusted by SLP (Slope) adjustment A5R48.

POWER SWEEP, BLOCK H

When POWER SWEEP mode is selected at the front panel, LEN 5 (Low Enable 5) is generated by A5U18, enabling A5U17 on. This allows power sweep data from data lines BD0 through BD7 to be loaded into A5U17. This data selects the gain of A5U14B by connecting or removing resistors in series with the input to A5U14B. The signal path of VSW, voltage sweep signal (0 to +10V), is through the selected gain resistors in A5U17 to input pin 6 of A5U14B. The feedback resistor for A5U14B is also within A5U17 and is internally connected to the input of the amplifier stage. The output of A5U14B is summed at the input of A5U14A with the ALC flatness signal. The output of this block is sent to the power level reference in the ALC circuit.

When the plug-in front panel SLOPE key is pressed, data lines BD0 through BD7 redefine the gain of the power sweep circuit to compensate the slope of the RF output in dB/GHz

Table 8-14. Connector Pin Descriptions

A5P1		PIN	SIGNAL	I/O	TO/FROM	BLOCK
1	23	NC	PWR SW/COMP	OUT	A4P1-5	I
2	24	LO FREQ FM	FREQ TRK V	OUT IN	A6P1-25 A2J1-36	E I
3	25	NC	VSW	IN	P2-64	G
4	26	NC	NC			
5	27	L INST1	+5V	IN IN	A3P1-8 A3P1-6,7	A J
6	28	NC	-15V	IN	P2-28	J
7	29	+10V	NC	IN	P1-8	J
8	30	GND DIG	GND DIG			J J
9	31	BD1	BD0	IN IN	A3P1-9 A3P1-31	C,G C,G
10	32	BD3	BD2	IN IN	A3P1-10 A3P1-32	C,G C,G
11	33	BA1	BA0	IN IN	A3P1-11 A3P1-33	A A
12	34	BA3	BA2	IN IN	A3P1-12 A3P1-34	A A
13	35	BD5	BD4	IN IN	A3P1-13 A3P1-35	C,G C,G
14	36	BD7	BD6	IN IN	A3P1-14 A3P1-36	G G
15	37	GND ANLG	GND ANLG			NOT USED J
16	38	+20V	+15V	IN IN	P1-7 P2-29	NOT USED J
17	39	-10V	FM RET	IN IN	P1-13 P1-A3	J B
18	40	NC	FM IN	IN	P1-A3	B
19	41	NC	FM RET	IN	P1-A3	B
20	42	HI FREQ FM RET	NC	OUT	A9J6	H
21	43	HI FREQ FM	NC	OUT	A9J6	H
22	44	HI FREQ FM RET	NC	OUT	A9J6	H

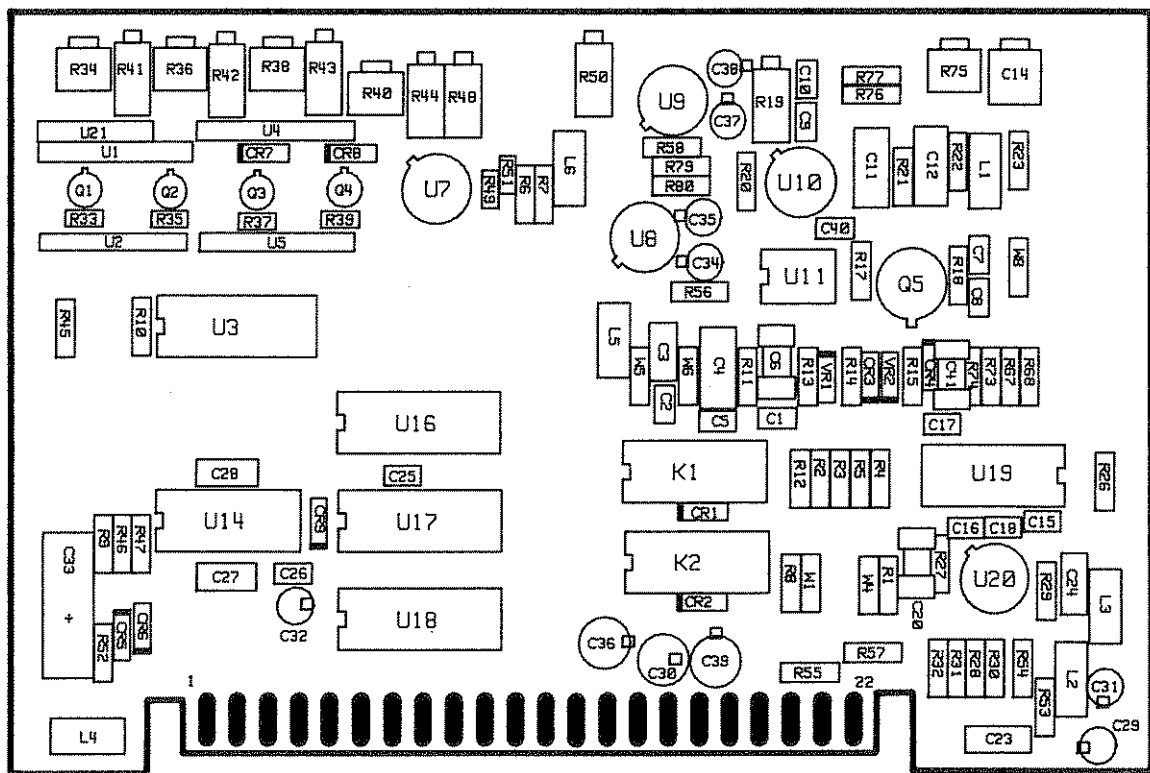
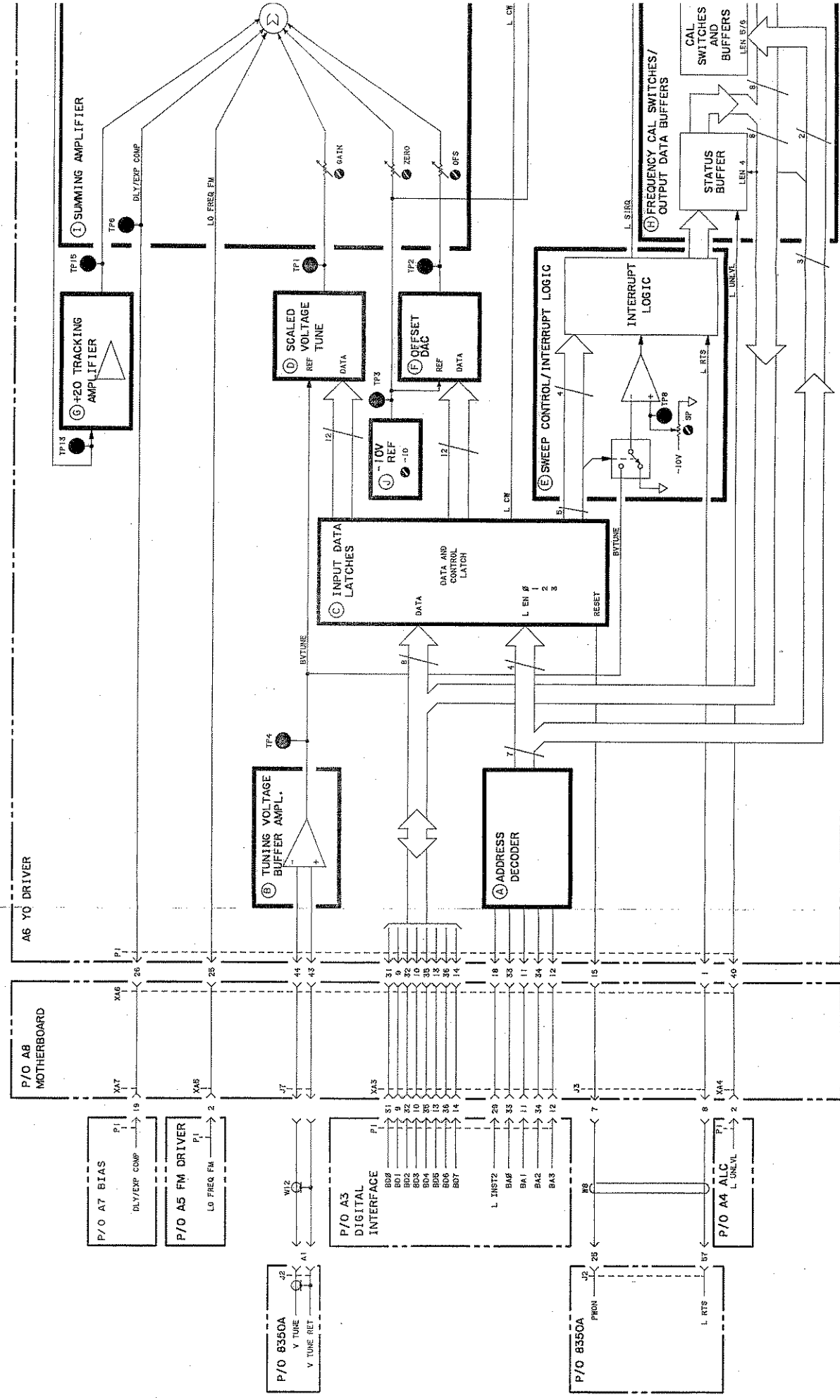

Figure 8-39. FM Driver Component Locations





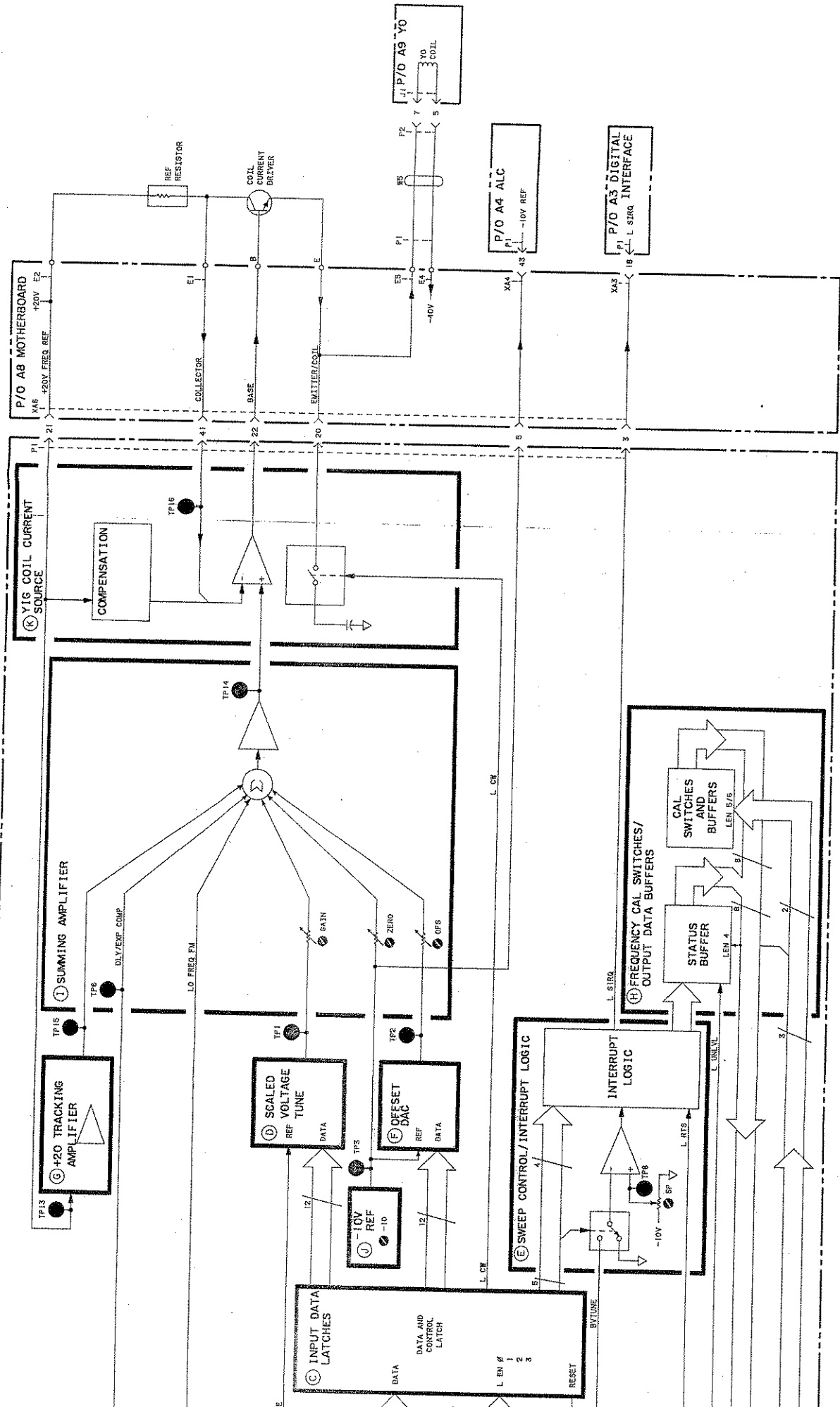
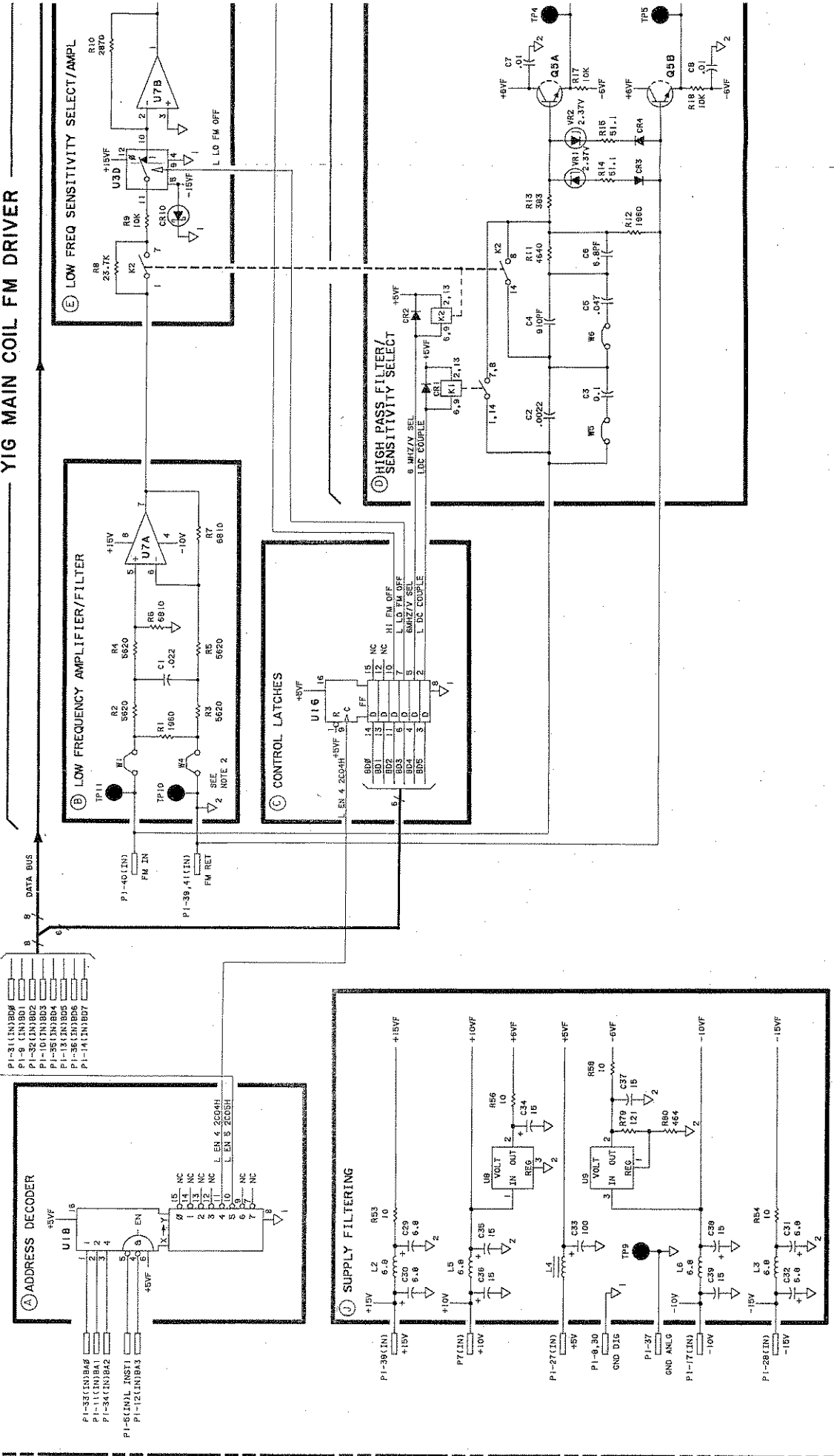
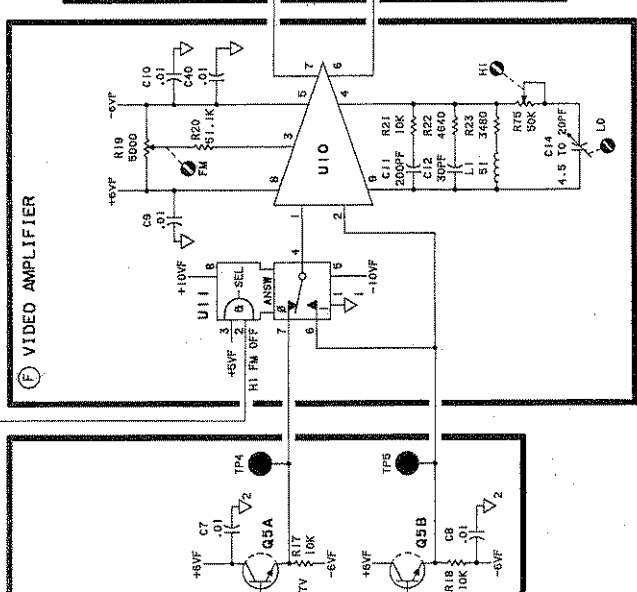
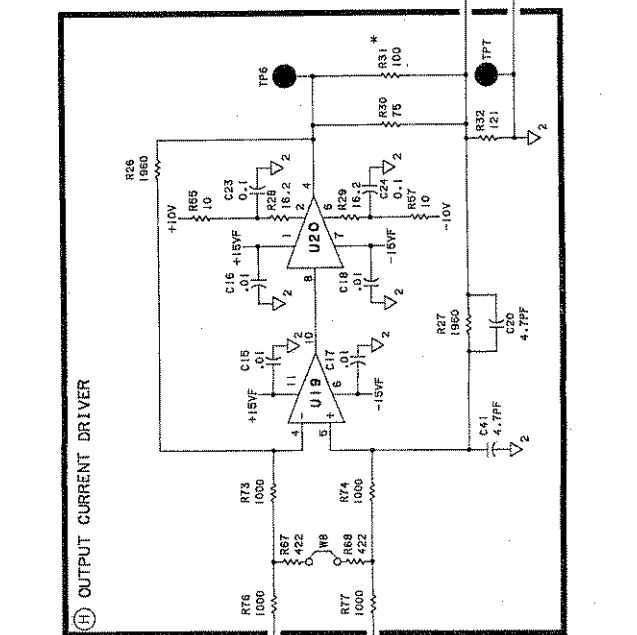
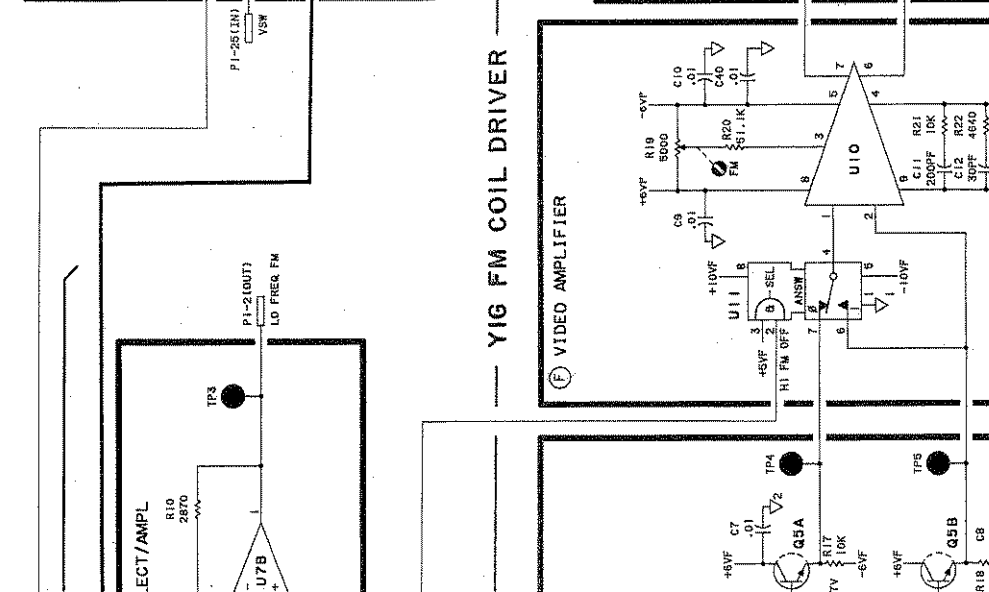
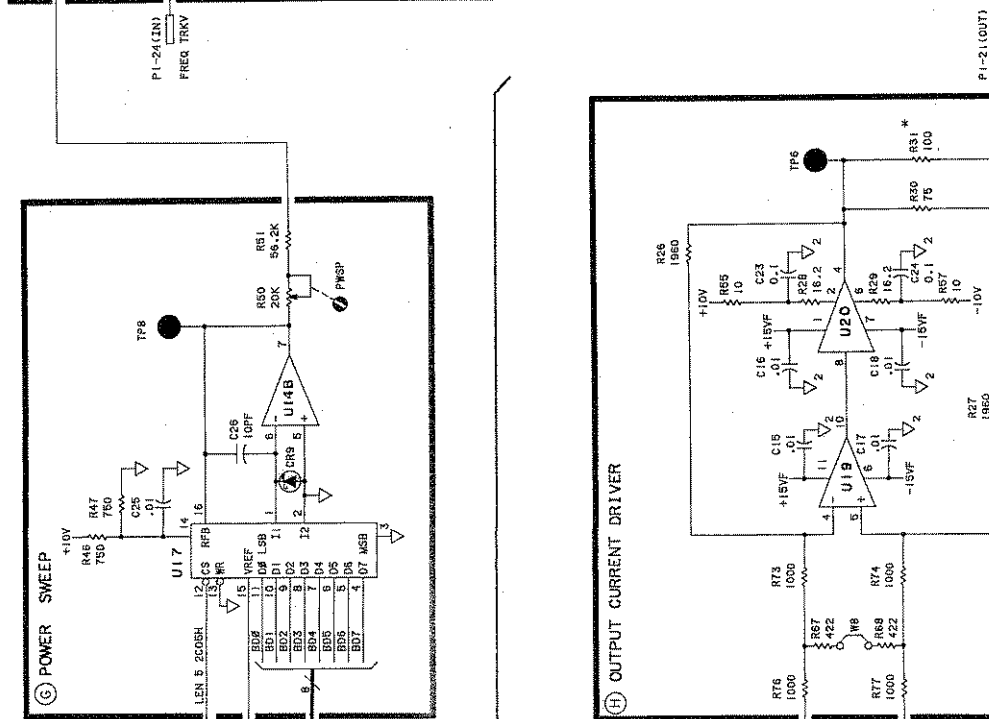
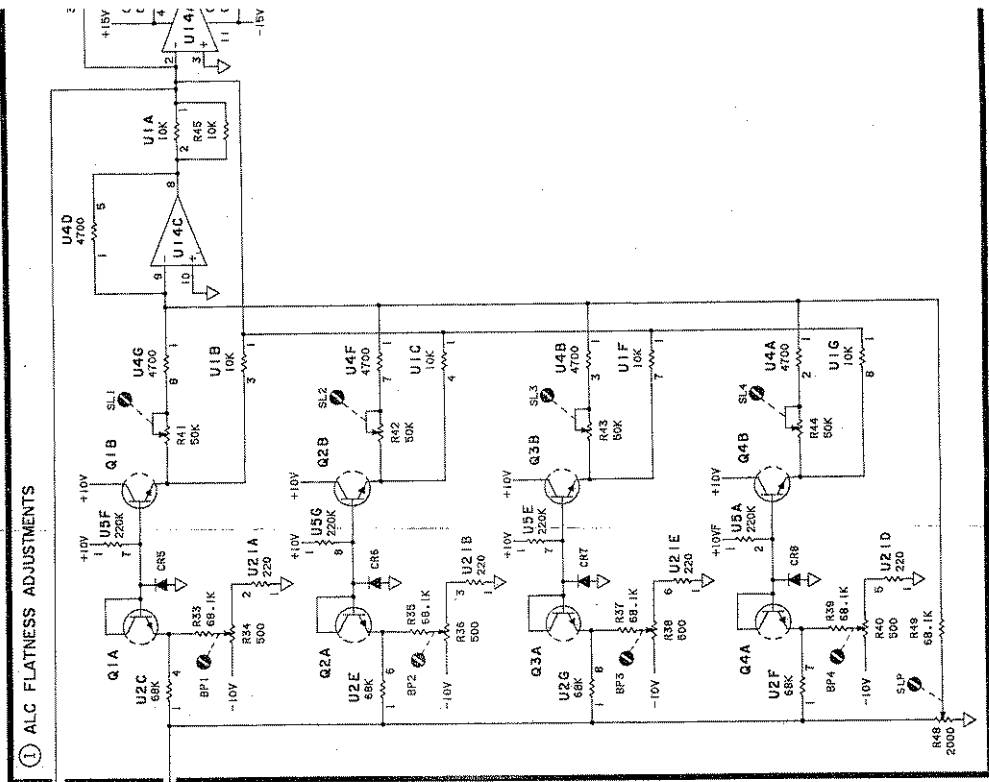

Figure 8-40. AF FM Driver, Overall Block Diagram
8-100-10-1-10

A5 FM DRIVER 83570-60043

YIG MAIN COIL FM DRIVER





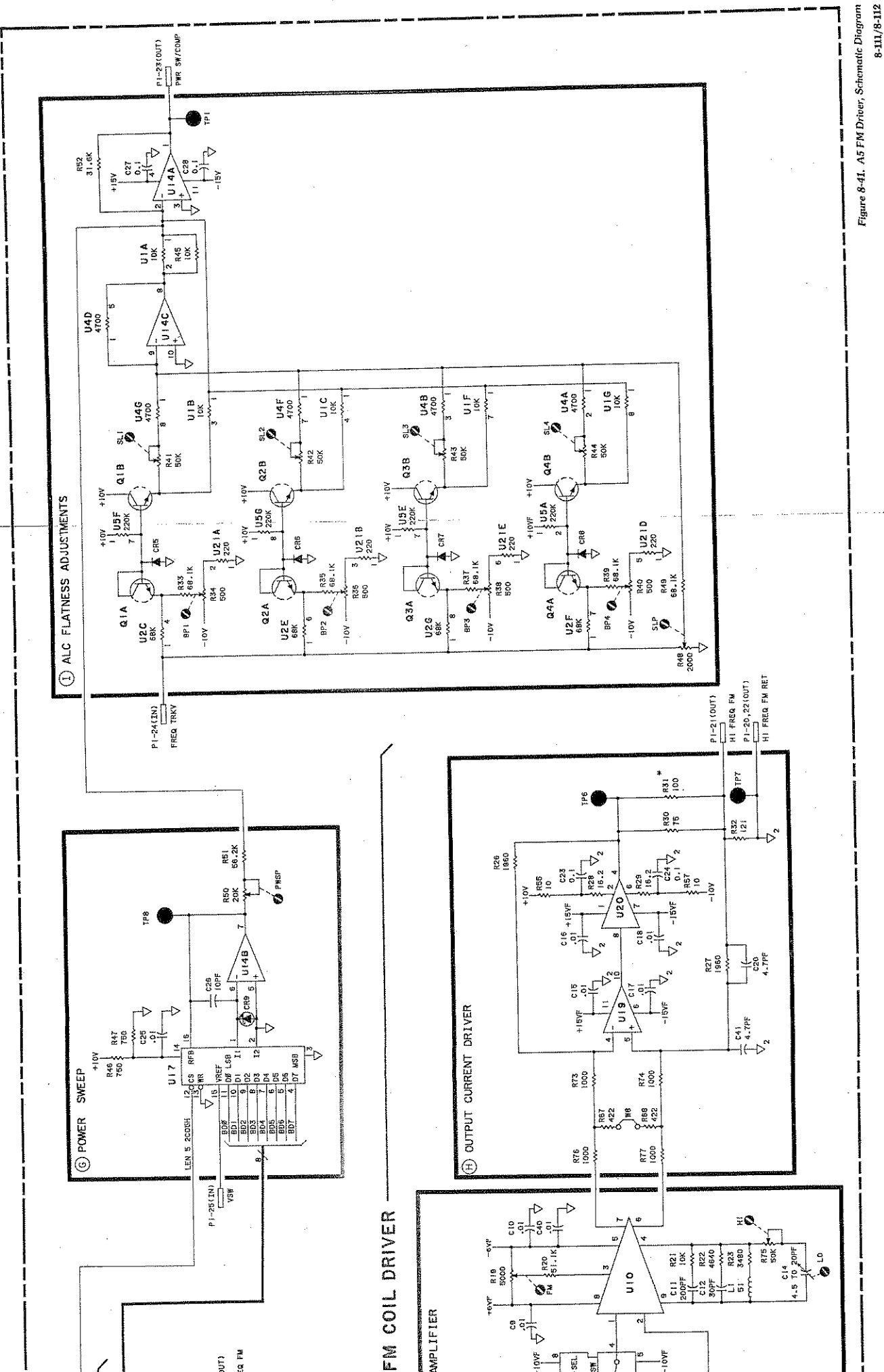

Figure 8-41. A5 FM Driver, Schematic Diagram 8-111/8-112

A6 YO Driver Troubleshooting

INTRODUCTION

The A6 YO driver assembly, along with several chassis-mounted and motherboard components, is primarily responsible for controlling the RF output frequency. A failure in this assembly usually results in large frequency errors that are independent of sweep time. (Frequency errors that change with sweep time are usually related to delay compensation. Refer to A7 Troubleshooting.) Frequency errors on the order of 500 MHz or less may be due to improper calibration. The problem may be relieved by performing the frequency accuracy adjustment in Section V.

GENERAL

Check that all power supply voltages are present. +20V (on the A6 assembly) and -40V (on the A8 Motherboard) supply the YO. Ensure that cable plugs are correctly seated over the correct jacks throughout the plug-in. With the line power off, remove and reseal the A6 assembly to assure good motherboard contact.

NOTE: Unless specifically stated otherwise, the troubleshooting waveforms and voltages described below occur when the plug-in is sweeping across its full range (INSTR PRESET conditions).

SWEEP CIRCUITRY

A failure in the sweep circuitry may cause the YIG to sweep between improper frequency endpoints or not sweep at all.

1. Check the YO DRIVE V (TP14) for the waveform shown in Figure 8-44. If this waveform is correct, troubleshooting should continue with the YO drive circuit section below.
 - a. If YO DRIVE V is incorrect, check BVTUNE (TP4) for the waveform shown in Figure 8-43. If it is missing or of the wrong amplitude, trace the problem back through the inputs of A6U10 (both should be close to 0Vdc) to the sweep ramp output of the 8350.
 - b. If the waveform at TP14 appears to be level-shifted, check -10 VREF (TP3) for -10 Vdc \pm 1 mV. Then, check TP2 for approximately +8.5 volts. If this voltage is incorrect, select a CW frequency of 26.5 GHz and press **[SHIFT] [5] [2]**. Check TP2 for the waveform shown in Figure 8-48. If this fails, check address decoding and the DAC latches using the digital control troubleshooting procedure described below.
2. If BVTUNE is correct, check SC VTUNE (TP1) against the waveform shown in Figure 8-43. If it appears to be bad, run the scale DAC test by setting a CW frequency of 26.5 GHz and pressing **[SHIFT] [5] [2]**. Check that A6U9 pin 17 is at -10 Vdc. Then check TP1 for the waveform shown in Figure 8-48. If this fails, check address decoding and the DAC latches using the digital control troubleshooting below.
3. Check +20V FREQ REF (TP13) for +20 Vdc \pm 10 mV. If it is not, trace the supply voltage back to the 8350. Then check that SUPPLY VOLTAGE CORRECTION (TP15) is at approximately -11.4 Vdc. If it is not, troubleshoot A6U11.
4. Finally, check that the summing junction, A6U16 pin 2, is at 0 Vdc. If it is not, troubleshoot A6U16.

YO DRIVE CIRCUITS

1. Check +20V FREQ REF at TP13 for +20V \pm 10 mV. If it is not, troubleshoot back to the main-frame supply.

The circuitry surrounding A6U24 and chassis-mounted Q1 is responsible for converting the YO DRIVE V to a drive current for the YO coil. A failure here will usually result in gross frequency errors.

2. Press [INSTR PRESET] to sweep the entire range of the plug-in. Check TP12 for the waveform shown in Figure 8-46. This represents the voltage (not the current) across the YO's main coil, and will give an indication as to whether current is passing through the coil. If this waveform is correct, suspect the YIG oscillator.
3. Check TP16. This voltage should track the YO DRIVE V (Figure 8-44). If it does not, troubleshoot A6U24, A6Q3, A6Q2, chassis R1 and R2, and chassis Q1.
 - a. R1 and R2 can be checked by removing one lead from the motherboard. The ohmmeter reading should be approximately 66 ohms.
 - b. Remove the chassis-mounted drive transistor, and check the collector-base and base-emitter junctions with an ohmmeter. These junctions should show only a few hundred ohms when forward biased, and a high impedance in the reverse direction. If Q1 is found to be shorted or opened, make sure that protection diodes A6VR1 and A6CR6 are good before replacing the transistor.
 - c. A6Q3 and A6Q2 can be checked, using the procedure above, while they are still in the circuit. The line power should be off.
 - d. Motherboard components, A8CR1 and A8VR1, protect the YO coil from high voltage transients. Measure the voltage drop across these components to determine if they are shorted.
 - e. If all the above components appear to be functional, suspect A6U24.

INTERRUPT CONTROL, BLOCK E

1. Place the A6 assembly on an extender board. With an oscilloscope, check L SSRQ (P1-23) for approximately +4.5V. Since band-switch circuitry is disabled, the only time L SSRQ should be low is when used in conjunction with external equipment requiring a stop sweep, or when programmed through the HP 8350 auxiliary programming connector.
 - a. If L SSRQ is low, check that A6U5 pin 3 is at ground. If it is not, check the L BSE line for approximately +4.5V. Then troubleshoot switch A6U26.
 - b. If A6U26 is good, ensure that A6U17A pin 5 is not held high. If it is good, chances are that other lines are pulling L SSRQ low. Refer to HP 8350 Operating and Service Manual to determine the source of the error.

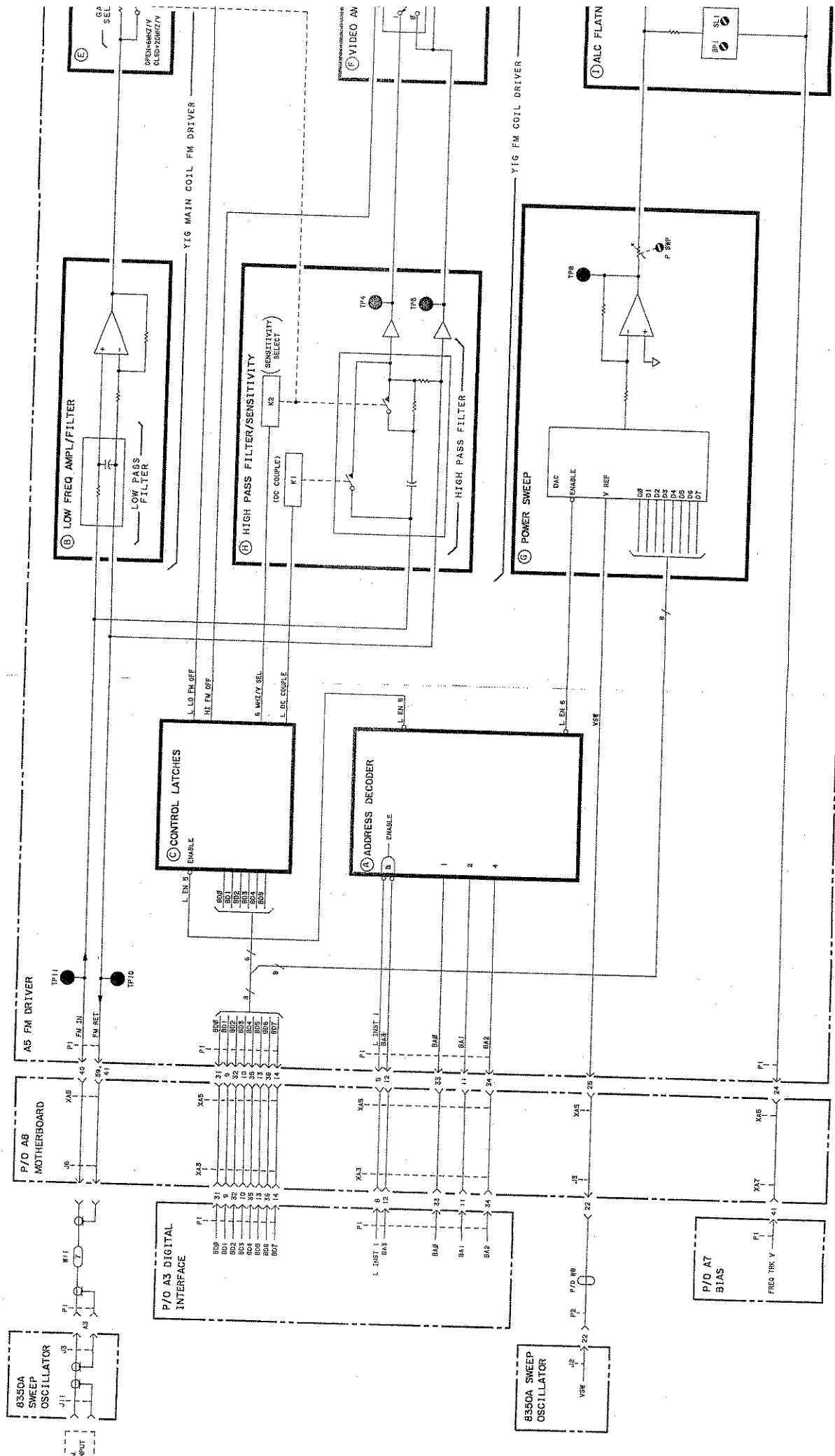

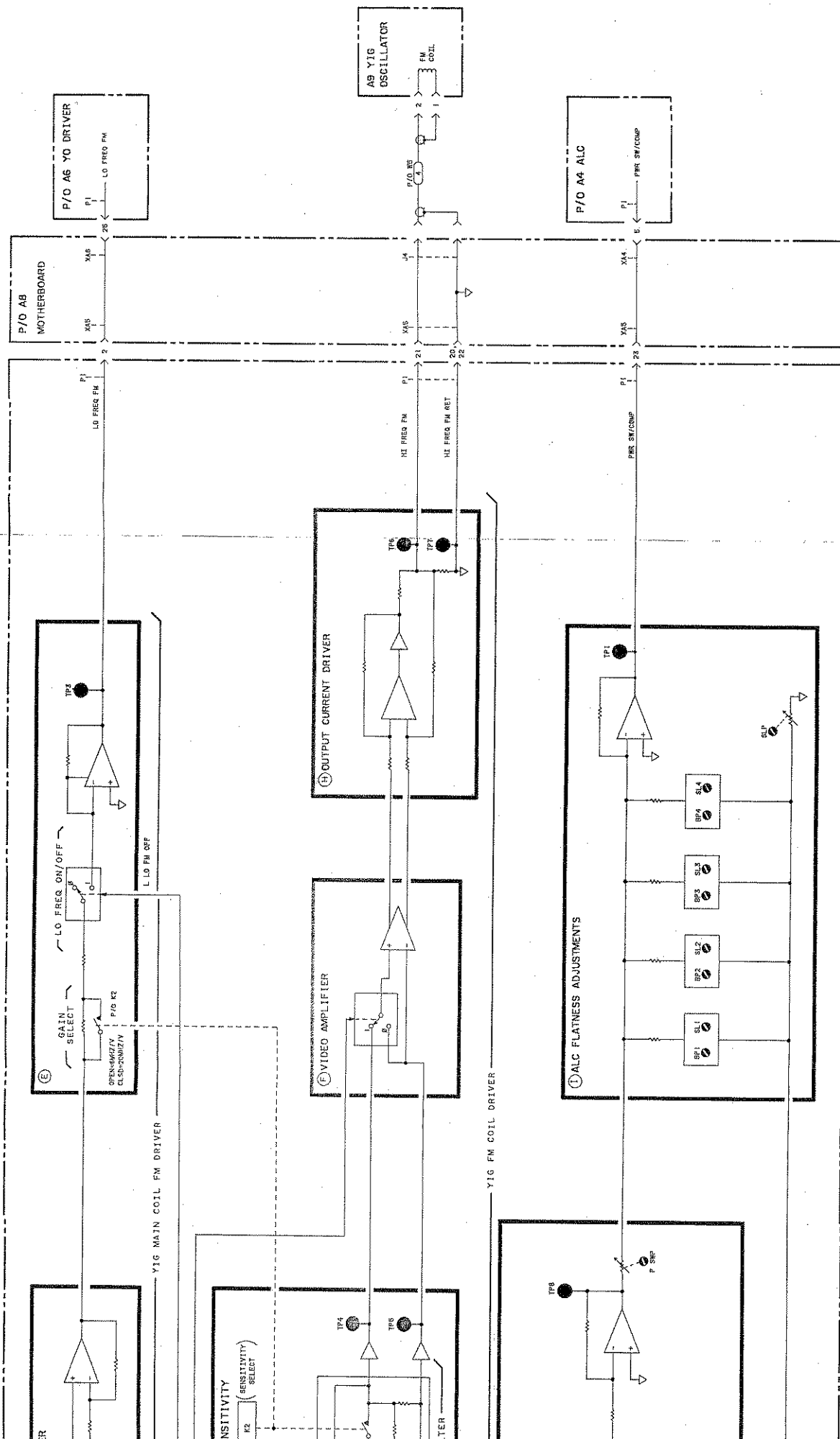
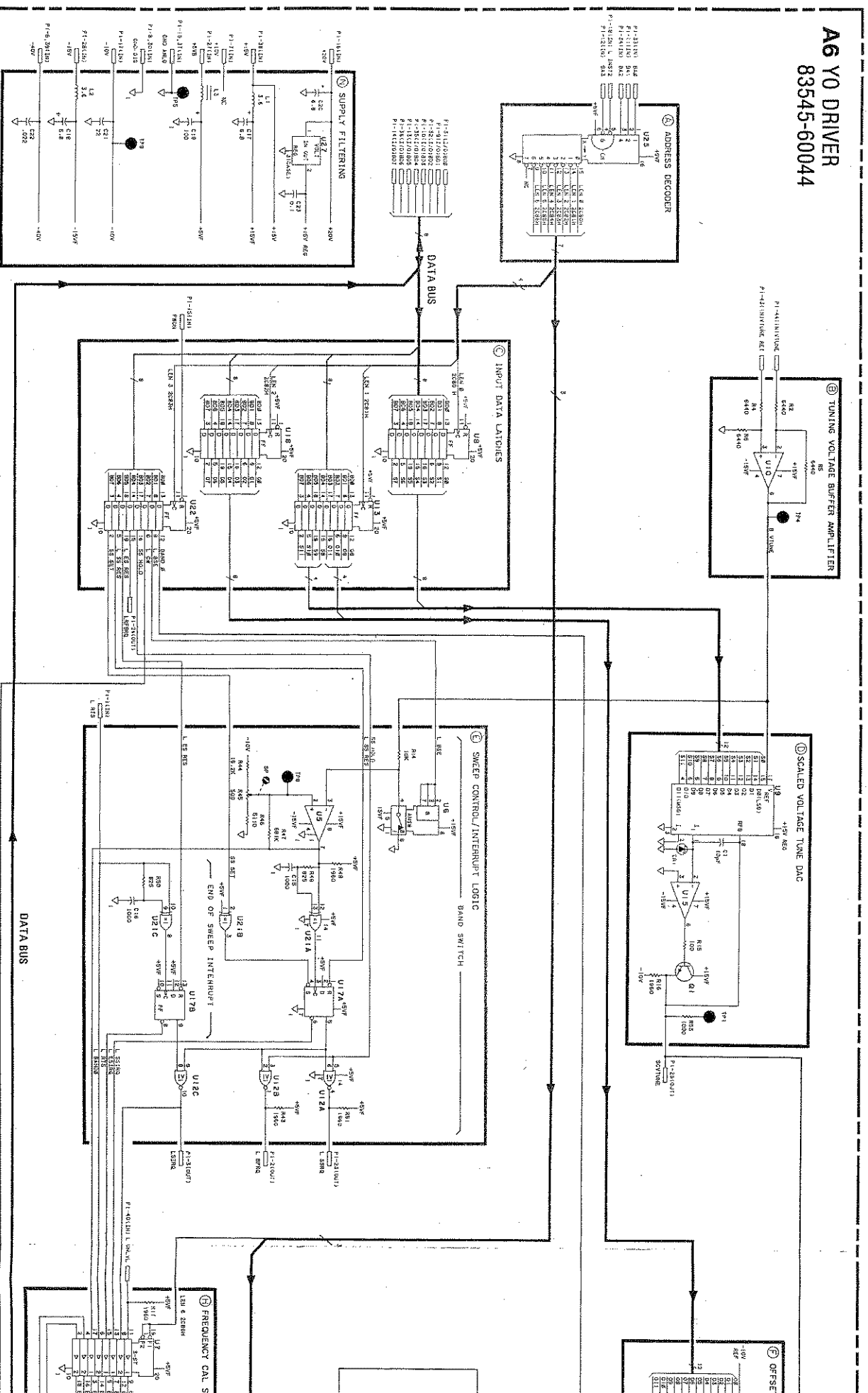

Figure 8-50. A6 YO Driver, Overall Block Diagram



A6 Y0 DRIVER 83545-60044



SERIAL PREFIX: 2820A

A8 MOTHERBOARD

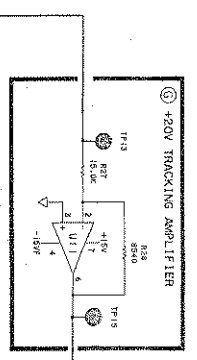
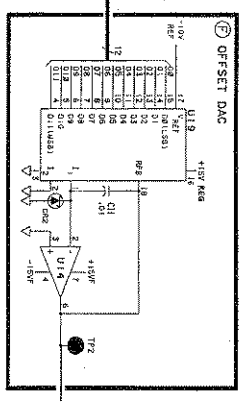
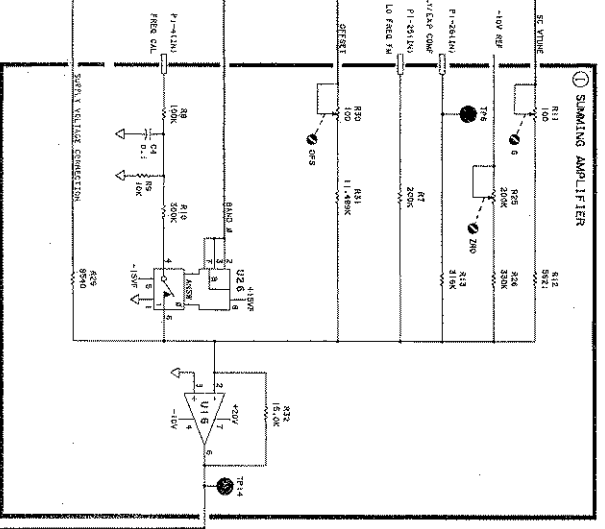
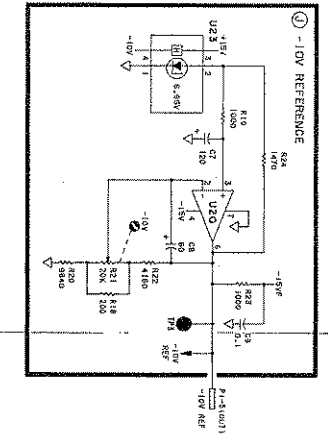

VIS COIL CURRENT SOURCE

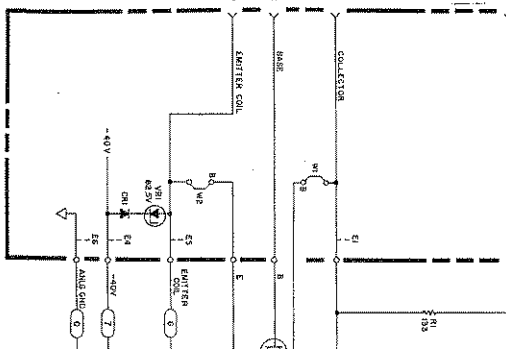
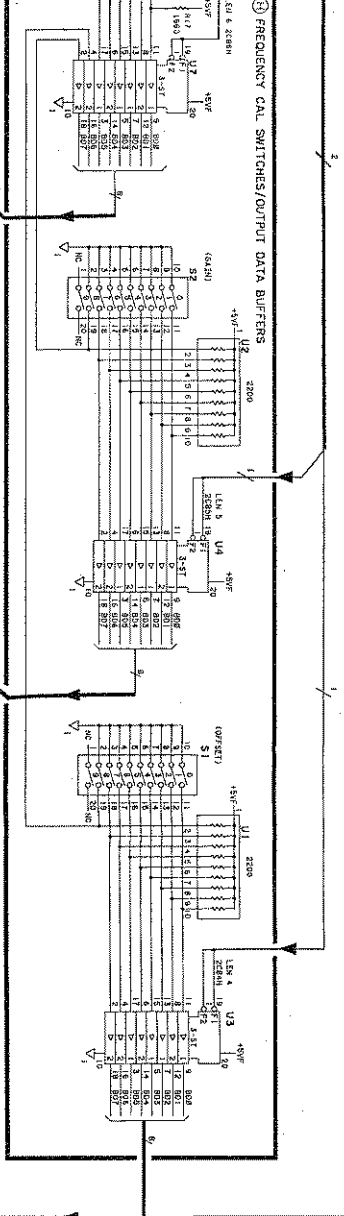
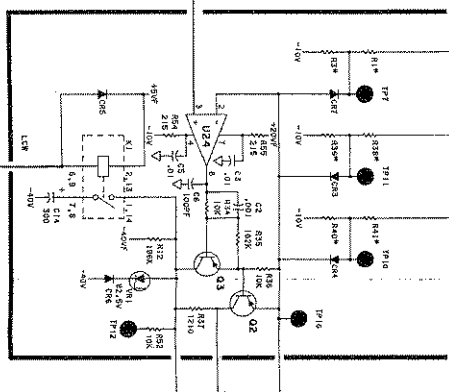

Figure 8-51

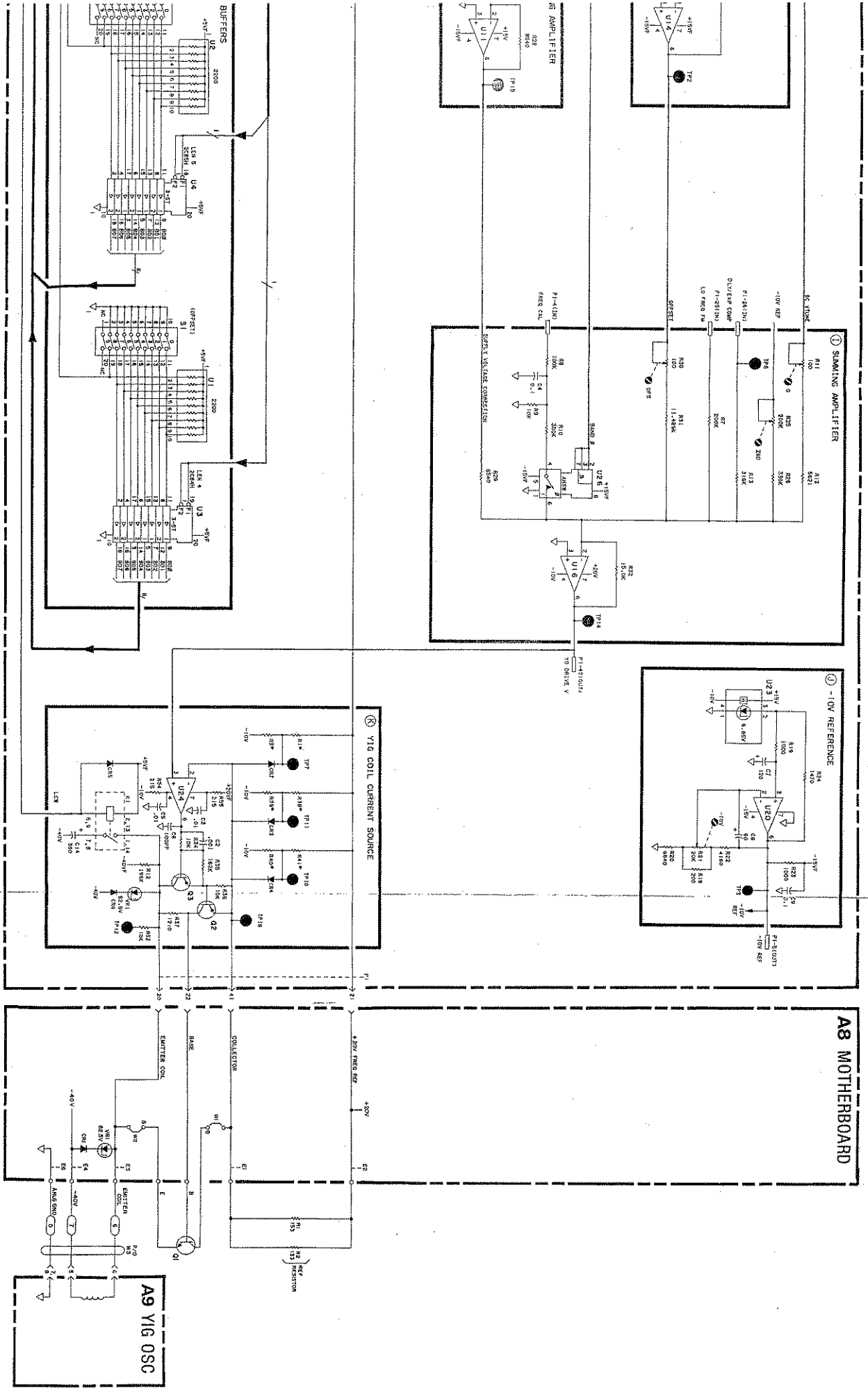

Figure 8-51. A6 Y/O Driver, Schematic Diagram



2. Check the edge-connector pins P1 through P3 (LSIRQ) and P1-1 (LRTS).
 - a. L RTS should appear as illustrated in Figure 8-43, with a low pulse occurring at the end of each forward sweep. If L RTS is not correct, trace the problem back through the plug-in interconnects to the HP 8350.
 - b. LSIRQ should pulse low briefly for end of sweep interrupts as illustrated in Figure 8-43. If these pulses are missing, but L RTS is present, suspect A6U21C, A6U17B, or control lines from A6U22.
 - c. If LSIRQ stays low, or the pulses are exceptionally wide, check A6U22 with the procedure outlined under digital control. If A6U22 is functioning, the HP 8350 microprocessor probably did not receive the interrupt. Trace this signal back to the HP 8350.

DIGITAL CONTROL, BLOCKS A, C, AND H

The address decoder, the input latches, and frequency cal switches/output data buffers comprise the digital control for the A6 assembly. A failure in these components usually results in large frequency errors.

To check the address decoding circuitry, enter **[SHIFT] [5] [4]** and perform the following:

1. Examine LINST2 (P1 through P18) for activity. If none is found, troubleshoot the A3 assembly.
2. IF LINST2 is functional, check each of the LENn lines (A6U25) for the pulses shown in Figure 8-47. If these are correct, but the address lines show activity, replace A6U25. If the address lines seemed locked high or low, troubleshoot the address buffer on the A3 assembly.

NOTE: A6U3, A6U4, and A6U7 are checked by reading data while changing frequency calibration switch settings. Before altering the switch settings on A6S1 and A6S2, write down the present configuration. Return the switches to their original status after troubleshooting. If this is not done, the frequency endpoints will have to be recalibrated.

3. To check status buffer A6U7 (Block H), press **[INSTR PRESET]**. Set the HP 8350 for a 5 second sweep rate and make the following key entry:

[SHIFT] [0] [0] [2] [GHz] [8] [6] [M3]	Enters the Hex data command Address location 2C86 (U7) Hex data read
---	--

The hex digit keys displayed in the HP 8350 front panel FREQUENCY/TIME window should change as the status read by A6U7 changes between forward sweep and retrace. Raising the power level until the UNLEVELED light comes on should also change the status bit being read by A6U7. Switches S1 and S2 can be toggled to test the last two bits.

4. A6U3 and A6U4 can each be checked with hex data read (see above) at address 2C84 and 2C85. The hex digits should change with the corresponding frequency calibration switches.
5. Exercise A6U22 with hex data rotation write. Enter:

[SHIFT] [0] [0] [2] [GHz] [8] [3] [M4]	Enters Hex Data command Address location 2C83 (U22) Hex Data Rotation Write
---	---

Check the outputs of A6U22 against the waveforms shown in Figure 8-2.

6. The remaining three latches, A6U8, A6U13, and A6U18 can be checked by selecting a CW frequency of 26.5 GHz and pressing **[SHIFT] [5] [2]**, to initiate the scaling/offset DAC test. The waveforms at TP1 and TP2 should be checked against those in Figure 8-48. If these are faulty, check the outputs of the latches, and replace them if necessary. If the bit patterns are correct, but the waveforms are not, replace the appropriate DAC.

—10V REF, BLOCK J

Check TP3 for $-10\text{Vdc} \pm 1\text{ mV}$. If this voltage is incorrect, perform the -10V reference adjustment procedure provided in Section V of this manual. If the adjustment cannot be made, check A6U23 pin 2 for $-6.95\text{ Vdc} \pm 0.15\text{ mV}$. If this voltage is incorrect, replace A6U23. Check A6U20 pins 2 and 3 for $-6.95\text{ Vdc} \pm 0.15\text{ mV}$. If either measurement is incorrect, troubleshoot A6U20 and associated circuitry.

CW FILTER, BLOCK K

Relay A6K1 and A6C14 reduce residual FM by filtering the noise from the YO Coil current. The relay is actuated by a line from A6U22. To check the data line, press **[CW]** on the HP 8350 and enter:

[SHIFT] [0] [0] [2] [GHz] [8] [3] [M2] [0] [0] [BKSP]	Enters Hex Data command Address location 2C83 (U22) Hex Data Write Enters hex data 00 and FF
--	---

Alternate between 00 and FF. Check A6U22, pin 6. If it is dead, make sure protection diode A6CR5 is good. Then replace A6U22.

If A6U22 is working, alternate between 00 and FF, as described above, and verify that contacts in relay A6K1 are opening and closing.

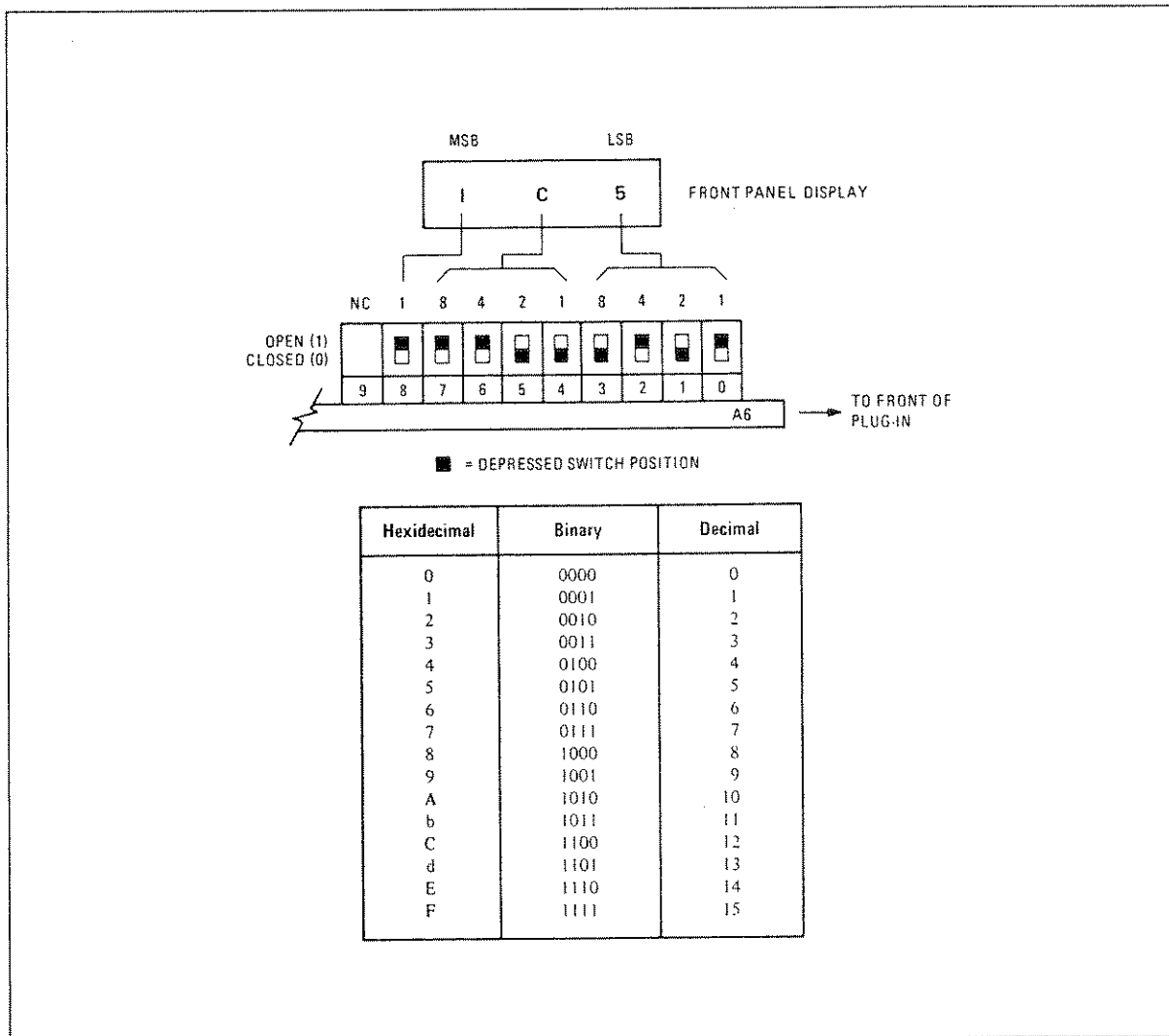

Figure 8-42. A6S1/S2 Switch Configuration

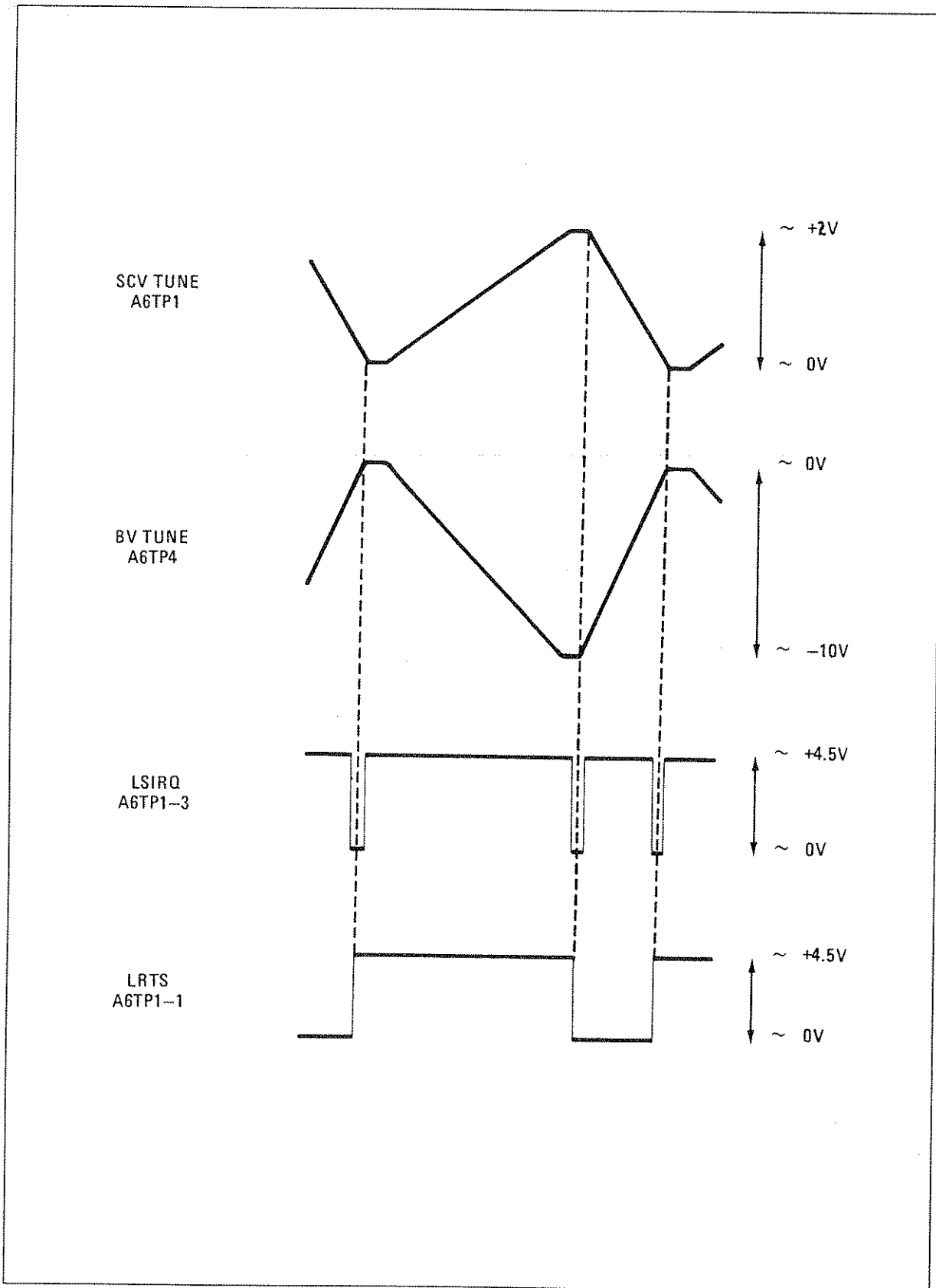

Figure 8-43. A6 Sweep Control and Interrupt Waveforms

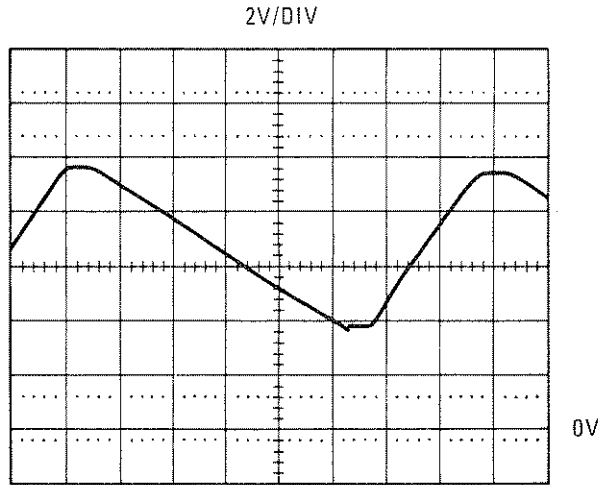

Figure 8-44. YO Drive V (A6TP14)

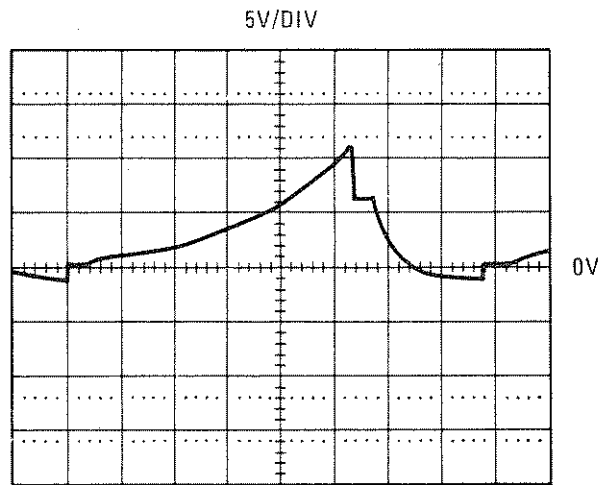

Figure 8-45. DLY/EXP Compensation (A6TP6)

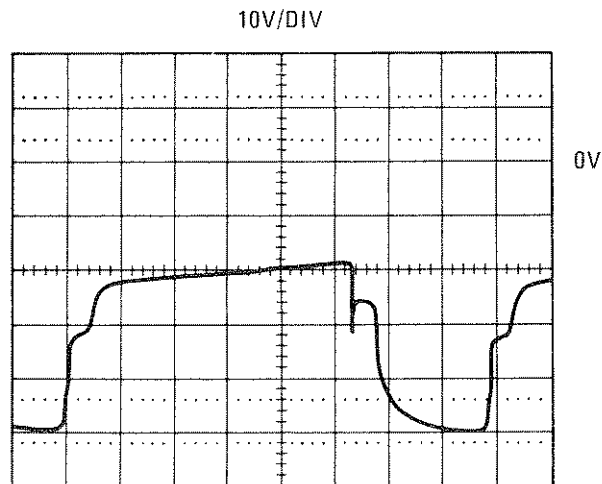

Figure 8-46. Emitter/Coil Waveform (A6P1-20)

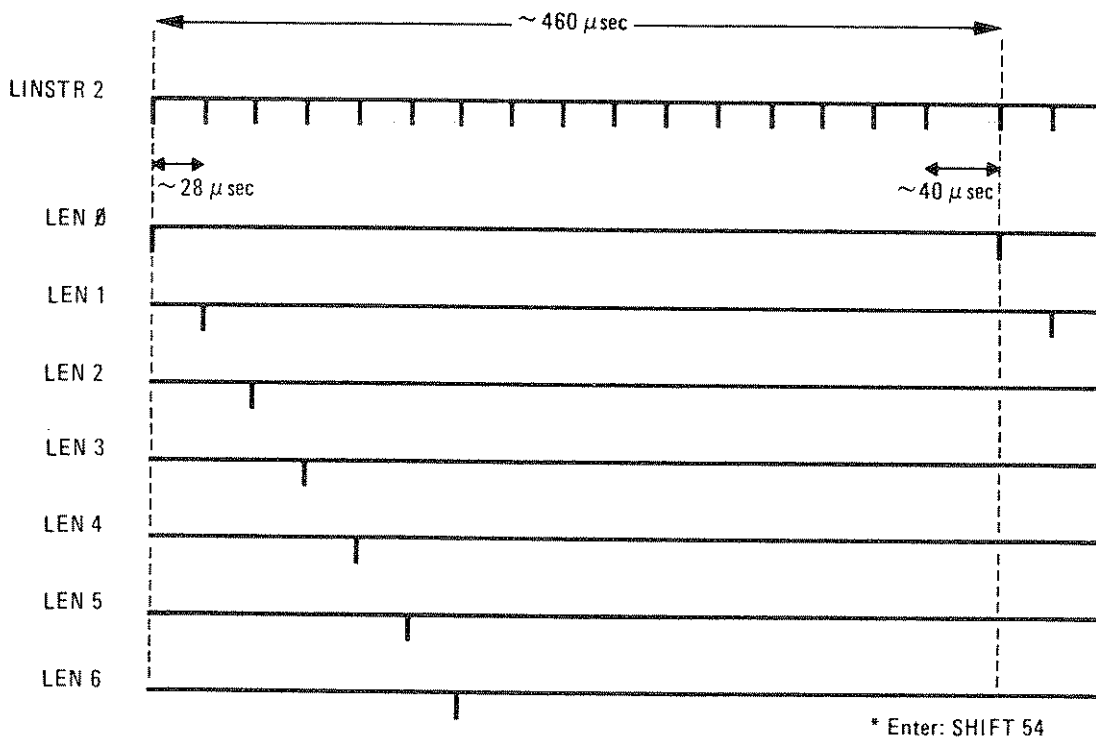
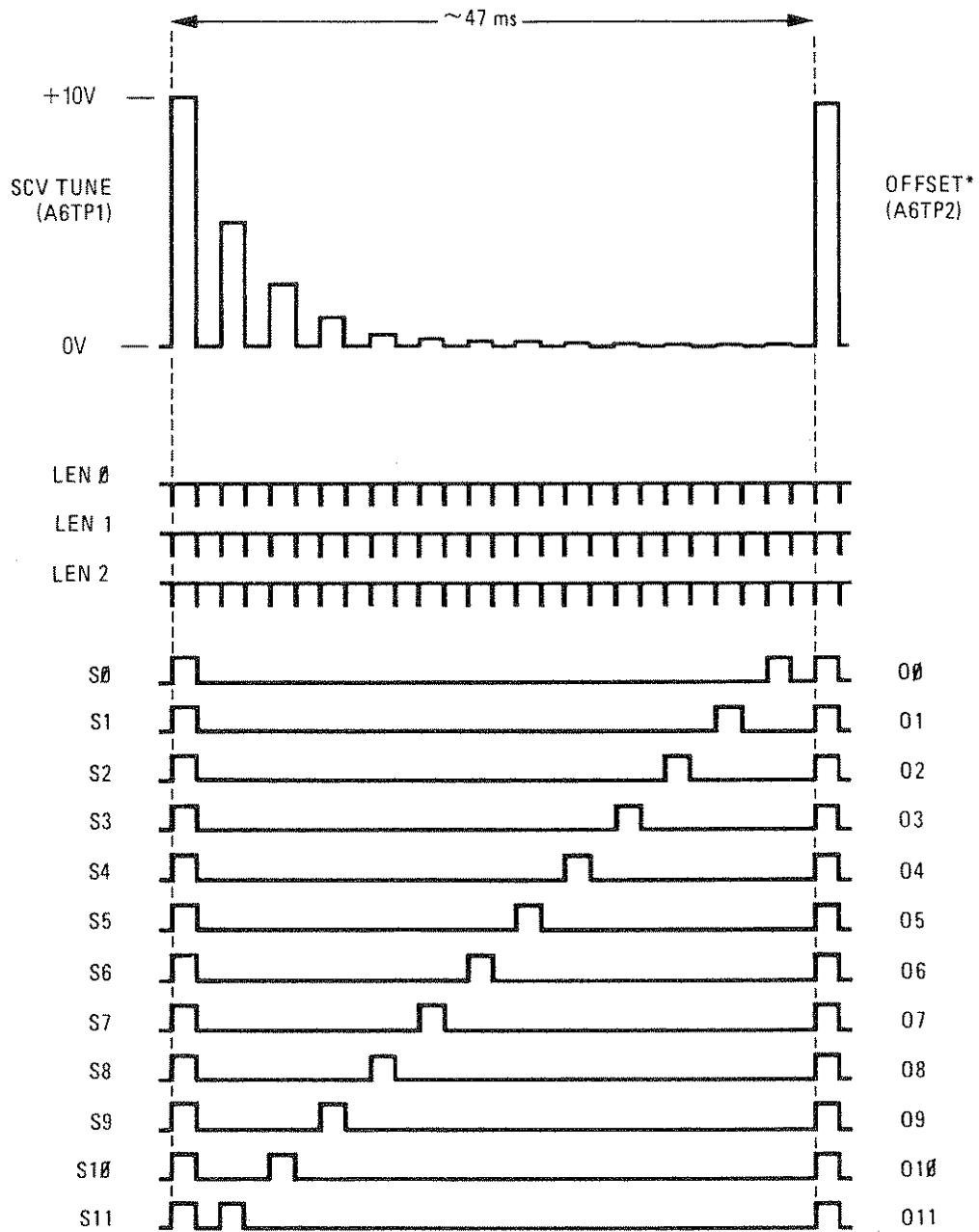

Figure 8-47. A6 Decoder Timing Diagrams*



Set CW = 26.5 GHz
 Press: SHIFT 52

*Waveform at TP2 will have slightly rounded edges due to larger feedback capacitor.

Figure 8-48. DAC Test

A6 YO Driver, Circuit Description

INTRODUCTION

The A6 YO driver assembly converts the tuning voltage from the HP 8350 mainframe into a drive current. Q1, mounted directly on the plug-in chassis, is the current driver controlling the frequency of the YIG oscillator (YO).

Multiplying digital-to-analog converters (DACs) scale and offset the buffered tuning voltage to the frequency end-points of the plug-in. A summing amplifier adds delay and exponential compensation and low frequency external FM. The resultant waveform at TP14 is then converted to a current-drive for the YO's main coil. Sweep control circuitry interrupts the microprocessor at the end of each sweep. (Band-switch circuitry is disabled in single band plug-ins.)

TUNING VOLTAGE BUFFER AMPLIFIER, BLOCK B

A6U10 receives the tuning voltage from the 8350 mainframe and buffers it for use on the rest of the board. The circuit is arranged as a differential amplifier, with the tuning signal appearing at the inverting input and the cable shield at the non-inverting terminal. This provides good common mode rejection to eliminate noise picked up on the cable. The waveform at TP4 is an inverted ramp, ranging from 0 to -10V for sweeping the full range of the plug-in. See Figure 8-43.

SCALED VOLTAGE TUNE DAC, BLOCK D OFFSET DAC, BLOCK F

A6U9 is a 12-bit multiplying DAC, which scales the tuning voltage according to the binary pattern loaded at its inputs. Inverting amplifier A6U15 and emitter-follower A6Q1 are included in the feedback path to provide the current gain needed to drive later stages. A6CR1 prevents transients from damaging the DAC during turn-on. A6C1, along with the DAC's internal feedback resistor, determine the bandwidth of the circuit. The waveform at TP1 is a scaled ramp, with a maximum range of 0 to $+10\text{VDC}$. See Figure 8-43.

A6U19 is a 12-bit multiplying DAC which scales a stable -10V REF voltage according to the binary pattern loaded at its inputs. Inverting amplifier A6U14 works with the DAC's internal feedback resistor to provide a programmable offset voltage between 0 and $+10\text{Vdc}$ at TP2. In the 83570A plug-in, TP2 is typically $+8.5$ volts. A6CR2 protects the DAC from turn-on transients. A6C11 and the DAC's internal feedback resistor determine the bandwidth of the circuit.

SC V TUNE and the offset DAC function together to determine the frequency of the YIG oscillator. The offset DAC determines the start frequency while the scaling DAC sets the gain of A6U16 so that SCVTUNE determines the high end frequency. For full band sweep, the entire 0 to -10 volt V TUNE is scaled and offset to sweep the YO from 9.0 to 13.25 GHz.

INPUT DATA LATCHES, BLOCK C

Four octal latches store various signals including the digital data for the scaling and offset DACs, and the control signals for the sweep control/interrupt logic circuit. Each latch is clocked by a separate line from the address decoder to store the byte of data appearing on the data bus.

A6U8 stores the 8 least significant bits (S0 through S7) for the scaling DAC, A6U9. The remaining four bits (S8 through S11) come from half of A6U13. Similarly, the least significant bits (O0 through O7) for the offset DAC come from A6U18, with the remaining four (O8 through O11) coming from the other half of A6U13. The 8350 microprocessor multiplexes the two numbers so that they can be loaded in three bytes.

A6U22 is a control latch which stores commands from the HP 8350 from the control lines used on the A6 YO driver assembly. (Several of these signals are associated with band-switching circuitry used in multiband plug-ins and therefore are not used in this application.) The command byte is latched into A6U22 when LEN3 pulses low. Refer to the summing amplifier, YO coil current source, and sweep control/interrupt logic sections for detailed descriptions of these control lines.

LRFBREQ is not used in single band plug-ins.

+ 20V TRACKING AMPLIFIER, BLOCK G

Inverting amplifier A6U11 monitors the +20V line (TP13, 15) used to supply current to the YIG oscillator. If the +20V supply becomes loaded down or drifts, the YO main coil current, and consequently the frequency, will try to change. However, A6U11 senses any drift in the +20V FREQ REF line, and provides a correction signal so that the resultant YO DRIVE Voltage (TP14) is compensated for the drift.

SUMMING AMPLIFIER, BLOCK I

A6U16 provides the summing point for the scaled tuning and offset voltages, and provides a drive voltage (YO DRIVE V) for the current driver. Several correction signals are summed at this junction:

SC V TUNE provides the scaled ramp portion of the YO DRIVE voltage. A6R11 (G) fine-tunes the range of the scaling DAC.

OFFSET adjusts the YO DRIVE voltage so that the YO coil is driven between the proper end points, as determined by the front panel controls. A6R30 (OFS) fine-tunes the range of the offset DAC.

SUPPLY VOLTAGE CORRECTION provides a compensation signal from the +20V tracking amplifier to offset changes in the reference supply.

DLY/EXP COMP, from the A7 bias assembly, is added to correct for lags in the response time due to hysteresis and saturation of the YIG oscillator magnet.

FREQ CAL is used in lower frequency plug-ins only. In this application, BAND 0 is held low by microprocessor control so that analog switch A6U26 is held open.

LO FREQ FM sums low frequency components of external FM signals from the A5 FM driver assembly with the drive voltage when crossover coupling of the FM signal is selected. (Configuration switch A3S1 provides this adjustment.) Due to the response time limitations in the YIG oscillator's main coil, only frequencies below 700 Hz are passed from the A5 FM driver assembly to the A6 YO assembly.

−10V REF and A6R25 (ZRO) adjust for gain and offset inaccuracies between A6U11 and summing amplifier A6U16.

− 10V REFERENCE, BLOCK J

A6U23 contains a low-noise 6.95V zener diode to provide a stable voltage reference for the rest of the plug-in. The package includes an internal heater to control its temperature and improve its stability. A6R19 and A6C7 filter the reference voltage to the non-inverting terminal of differential amplifier A6U20. A6R21 (−10V) adjusts the overall gain for exactly −10V at TP3. A6C8 limits the high-frequency gain of the system to reduce noise. A6R24 provides the bias current for the zener diode from the −10V REF output. A6R23, with filtering capacitor A6C9, increases the current drive capability of the −10V REF.

SWEEP CONTROL/INTERRUPT LOGIC, BLOCK E

Band-switch circuitry is disabled in this single band plug-in. The L BSE line from A6U22 is held high by microprocessor control, grounding the input to comparator A6U5. This effectively disables A6U5, A6U21A, and A6U17A.

In single band plug-ins, the SS HOLD line is also deactivated by microprocessor control, disabling A6U12A and A6U12B. However, L SSRQ (Low=stop sweep request) and L BPRQ (Low=blanking pulse request) are wired OR gate signals and may appear active at the output, via several other sources.

End of sweep interrupt circuitry interrupts the microprocessor at the beginning and end of each sweep. Each time LRTS (Low=Retrace Strobe) changes from high to low, or low to high, A6U21C pulses high. (Pin 9 of A6U21C is prevented from tracking pin 10 by A6C16. Consequently, the output of EXOR A6U21C will pulse high every time LRTS changes states.) Each pulse from A6U21C clocks flip-flop A6U17B. The non-inverting output of A6U17B pulls LSIRQ low and requests microprocessor attention. LRTS is read through A6U7 to determine whether the forward sweep is beginning (LRTS=high) or ending (LRTS=low). A6U17B is then reset by a control line from A6U22, and the microprocessor services the interrupt.

LRFBRQ is not used in this plug-in. It is activated only during band-switching in multiband plug-ins.

FREQUENCY CAL SWITCHES/OUTPUT DATA BUFFERS, BLOCK H

DIP switches S1 and S2, with their corresponding data bus buffers, are used to digitally calibrate low and high end frequencies. The data on these switches is read by the microprocessor during power-up and INSTR PRESET and used to calculate the settings for the scale and offset DACs. S1, with pull-up resistor package A6U1, is read through A6U3 when enabled by LEN4. S1 determines the value of the offset DAC and calibrates the low end frequency. S2, with pull-up resistor package A6U2, is read through A6U4 when enabled by LEN5. This establishes the scale DAC values, and calibrates the high end frequency. The ninth bits from S1 and S2 are read through A6U7.

S1 and S2 switch positions encode binary numbers to set up the offset and scaling DACs. Refer to the frequency accuracy adjustment procedure in Section V for instructions. Figure 8-42 illustrates the switch configurations.

The microprocessor reads A6U7 outputs each time it receives a retrace initiated interrupt to determine what action is required. L UNLVL, from the A4 ALC assembly, is read through A6U7. When the HP 8350 is under HP-IB control, the microprocessor alerts the controller to unlevelled power conditions.

SUPPLY FILTERING, BLOCK N

Power supply circuitry provides eight different voltages for the A6 YO driver and other assemblies. A6U27 provides a regulated +15V supply for the DACs. The other supplies use capacitive or LC filtering to reduce supply noise.

YO COIL CURRENT SOURCE, BLOCK K YO COIL CURRENT DRIVER, Q1

The YIG coil current driver works with chassis-mounted components reference resistors R1, R2, and YO coil driver Q1 to drive a current proportional to the drive voltage through the YIG's main tuning coil.

A6U24, A6Q3, A6Q2, and chassis-mounted Q1 comprise a voltage-to-current converter and current driver for the YO's main coil. The non-inverting input of A6U24 receives the YO DRIVE voltage signal. The inverting input of A6U24 monitors the voltage drop across the reference resistors R1 and R2, which is directly proportional to the coil current. If the drive current is not tracking the drive voltage, A6U24 will produce an error voltage to correct for the difference. Emitter-follower A6Q3 and common-emitter stage A6Q2 provide the current gain needed to drive Q1. A6Q3 and A6Q2 emitter currents are also drawn through R1 and R2, and therefore, sensed by A6U24. A6VR1 and A6CR6 protect the current drive transistors by limiting voltage spikes due to sudden changes in the coil current. A6R42 helps to dampen ringing caused by the parasitic capacitance and the inductance of the YO coil.

When HP 8350 [CW] and 83570A [CW FILTER] are selected, LCW goes low, energizing relay A6K1. A6C14 filters out noise in the YIG coil current, reducing the residual FM noise in the CW mode.

A6CR7, A6CR3, A6CR4, and their associated factory-select resistors provide a three break-point compensation network to correct for nonlinearities in the YO characteristics.

NOTE: The values of the factory-select resistors are stamped on a label attached to the RF casting. Matching resistor sets are supplied with replacement YOs and must be installed on the A6 YO assembly. The new label, indicating the replacement resistor values should be attached to the RF casting. If the A6 YO driver assembly is replaced, the shaping resistors from the defective board must be reinstalled in the new assembly. If the YO needs little or no compensation, some or all of the factory-select resistors may be omitted.

Table 8-15. Connector Pin Descriptions

A6P1				
PIN	SIGNAL	I/O	TO/FROM	FUNCTION
1 23	LRTS LSSRQ	IN	P2-57 Not Used	E H
2 24	LBPRQ LRFBRQ		Not Used Not Used	
3 25	LSIRQ LO FREQ FM	OUT IN	A3P1-18 A5P1-2	E I
4 26	FREQ CAL DLY/EXP COMP	IN	Not Used A7P1-19	I
5 27	-10V REF +5V	OUT IN	A4P1-43 A3P1-6, 7	J L
6 28	-40V -15V	IN IN	P1-11 P2-28	L L
7 29	+10V SCVTUNE	IN	P1-8 Not Used	L
8 30	GND DIG GND DIG		Dist	L L
9 31	BD1 BD0	I/O I/O	A3P1-9 A3P1-31	
10 32	BD3 BD2	I/O I/O	A3P1-10 A3P1-32	
11 33	BA1 BA0	IN IN	A3P1-11 A3P1-33	A A
12 34	BA3 BA2	IN IN	A3P1-12 A3P1-34	A A
13 35	BD5 BD4	I/O I/O	A3P1-13 A3P1-35	
14 36	BD7 BD6	I/O I/O	A3P1-14 A3P1-36	
15 37	PWON GND ANLG	IN	P2-25	C L
16 38	+20V +15V	IN IN	P1-7 P2-29	L L
17 39	-10V -40V	IN IN	P1-13 P1-11	L L
18 40	LINST 2 LUNLVL	IN IN	A3P1-29 A4P1-2	A H
19 41	GND ANLG COLLECTOR		A8E1	L
20 42	EMITTER/COIL YO DRIVE V		A8E5 Not Used	
21 43	+20V FREQ REF VTUNE RET	IN OUT	A8E2 P1-A1	B
22 44	BASE VTUNE	IN	Q1 (base) P1-A1	B

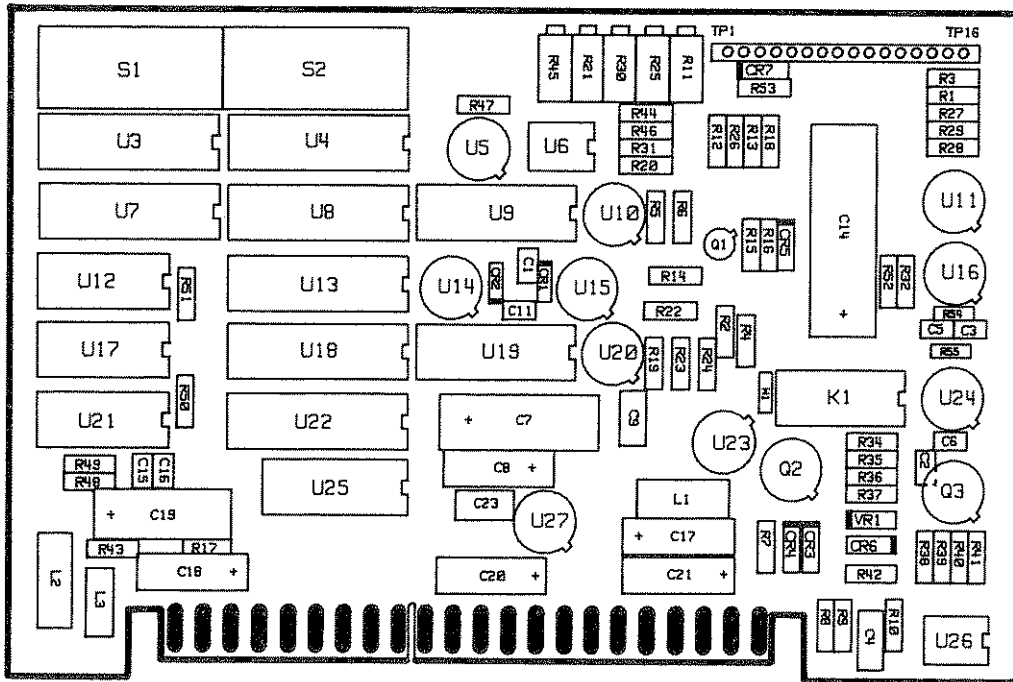

Figure 8-49. A6 YO Driver Component Locations

A7 Bias Troubleshooting

INTRODUCTION

The A7 bias assembly performs several unrelated functions. The functional subheadings listed below outline the organization of this troubleshooting section.

DIGITAL CONTROL

All data bus and control lines may be effectively checked by making use of the hex data programming and operator initiated checks available through HP 8350 software.

To verify address decoder A7U11, press **[CW]** on the HP 8350. Then enter **[SHIFT] [5] [4]**. In this mode, the HP 8350 microprocessor continuously strobes the plug-in address blocks. Check the LINST1 line and the output of A7U11 against the waveform provided in Figure 8-52a.

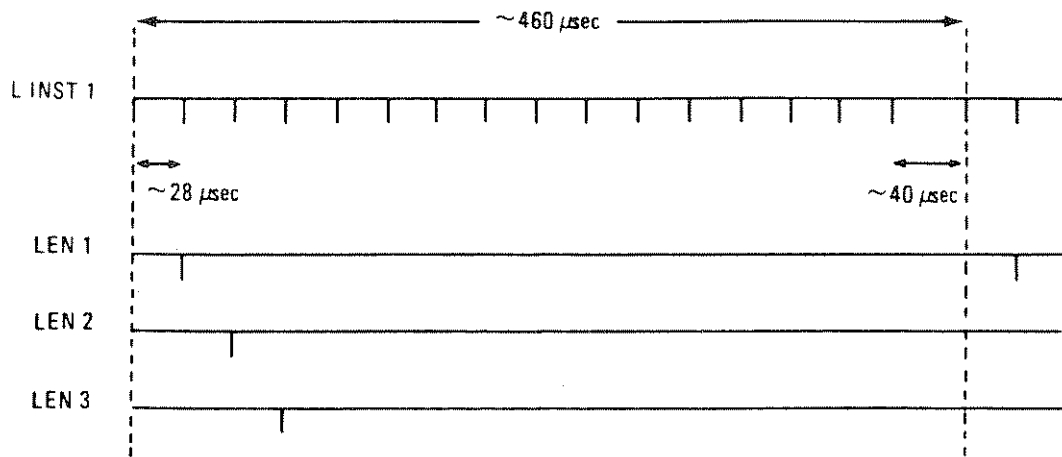

Figure 8-52a. A7 Address Decoder Timing Diagram

Verify operation of A7U14 with the following key entries:

[SHIFT] [0] [0] [2] [GHz] [0] [1] [M2] [5] [5]	Enters Hex Data Command Address location 2C01H (U14) Hex Data Write Enters byte with alternate high/low states
---	---

Check the outputs of A7U14 for the alternating high/low pattern. To obtain the complement of each of the A7U14 outputs, press **[.] [.]** (Hex byte AA). This will expose any locked latch registers.

V REF

A probable indication of failure in this block is loss of the YIG oscillator output.

Check TP1 for 8.00 Vdc ± 5 mV. If this voltage is incorrect, check the voltage across A7VR1 (+ 6.2 Vdc).

YIG BIAS

Check TP6 for approximately the same voltage as indicated on the YO label.

EXPONENTIAL AMPLIFIER

A failure in this circuit will result in high frequency roll-off above 19 GHz. To test this circuit, ground A7U3 pin 1. This disables part of the delay compensation circuit. Check the output of the summing amplifier at TP2 with an oscilloscope. If the signal is a flat line across the screen, ensure that -VTUNE is present at TP5. If TP5 is correct, then suspect A7U1 or A7Q1.

DELAY COMPENSATION, BLOCK D

Before troubleshooting this block, it is best to verify the - VTUNE input at TP5. Also check the stop sweep logic from the A6 YO driver assembly.

Sweep delay problems can be observed by displaying the RF output signal on a CRT and measuring the frequency shift with changes in sweep time. (Measure the frequency shift against the limits of the swept frequency accuracy specification listed in Table 1-1.) If the measured value is near specification, refer to Section V, Adjustments, and perform the delay compensation adjustments. The simplest way to troubleshoot this circuit is to check each functional area by using the available test points to expose typical signal waveforms.

NOTE: Signal waveforms produced in this circuit will vary from plug-in to plug-in dependent on several adjustments.

To check the voltage follower/subtractor, set the HP 8350 for the alternate sweep mode, 18.0 to 26.5 GHz and 20.0 to 24.0 GHz. Connect the oscilloscope probe to A7U4 pin 7. The ramped output should start at the same point on the CRT, but the slope of the ramps will be different. If the start points for both sweeps are not coincident, check the signal at the input to A7U2C pin 10. The level shift observed at the start of retrace indicates the switch is indeed closing during retrace. If this is true, suspect A7U2B and A7U2D.

The differentiator circuit produces a negative step proportional to change in sweep width/sweep time. To verify circuit operation, set the HP 8350 for ALTn sweep mode, alternating between sweep times of 10 and 100 milliseconds and check the signal at U7U7B pin 14. If this signal is good, and the voltage follower/subtractor has been verified, suspect the A7U3 multiplier.

If no problems are found on this assembly, refer to the A6 YO driver schematic and check the point where DLY/EXP COMP is summed into the YO DRIVE V.

PULSE MODULATION LOGIC, BLOCK F

To verify circuit operation, press HP 8350 [L] MOD]. Check TP4 and the L PULSE output for the proper squarewave (27.8 or 1 kHz dependent on an HP 8350 setting).

A7 Bias Assembly, Circuit Description

TUNING VOLTAGE DIFFERENTIAL AMP, BLOCK A

VTUNE and VTUNE return lines are input to differential amplifier A7U12A to provide common mode noise rejection. The output of the differential amplifier is then input to an emitter-follower amplifier A7Q6 to provide higher current drive capability. The output of this circuit drives exponential and frequency tracking amplifiers and the delay compensation circuits. It also drives biasing circuits on the A2 doubler assembly.

DIGITAL CONTROL SWITCH, BLOCK B

The A7 bias assembly uses address location 2C01H. A7U11 is a 3-to-8 line address decoder producing a low control signal used to enable A7U14. When A7U14 is enabled, the data bus information is latched through to the functional block in this assembly.

+8.0V REF VOLTAGE SUPPLY, BLOCK C

A7VR1 provides a reference voltage which is filtered by A7C23, A7R58, and A7C22. The filtered reference voltage is input to the non-inverting terminal of differential amplifier A7U9A. The output of the differential amplifier is then input to emitter-follower amplifier stage A7Q4 which provides increased current drive capability. A7R60 VREF adjusts the gain of A7U9A for exactly +8.0V at TP1.

DELAY COMPENSATION, BLOCK D

The delay compensation block is used to compensate the A9 YIG oscillator for swept frequency inaccuracy caused by delay in the oscillator magnets at fast sweep times. The input signal is -VTUNE, a 0 to -10 Vdc ramp proportional to frequency. -VTUNE is sent to two separate signal processors: (1) a voltage follower/subtractor whose output is equal to zero at the start of sweep. The amplitude is proportional to sweep width; and (2) a differentiator whose output is proportional to the rate of frequency change while sweeping. These two signals are then multiplied in the analog multiplier A7U3. If the sweep oscillator is in a swept mode, A7U2C through A7U10A enables the delay compensation.

During retrace, analog switch A7U2C closes. In this condition, A7U7B together with A7R18, A7R19, A7R20, and A7R22 form a subtractor circuit. Both inputs are the buffered tuning voltage so they cancel in the operational amplifier and the resulting output is 0V, regardless of the input level. With A7U2C closed, A7C7 charges to one half the value the input signal (A7R19 and A7R20 form a voltage divider). A7U2C opens again during the sweep which leaves only A7C7 in the feedback path of A7U7B. Since there is no discharge path with A7U2A and A7U2C open, A7C7 remains charged to the level it had just before A7U2C was opened. A7U7B now operates as a voltage follower, with the output level shifted by the voltage across A7C7. Therefore, the output of A7U7B has one-half the slope of the input signal and returns to 0V whenever A7U2C is closed during retrace. The output of A7U7B is scaled by the HI adjust potentiometer and is applied to inverting amplifier A7U4B.

If the sweep is stopped momentarily, such as when an external counter is used, L SSRQ is pulled low by the HP 8350. SLOW enables gate A7U13B and allows the L SSRQ line to control analog switch A7U2A. When A7U13B is enabled by a high on the SLOW control line, and L SSRQ goes high, A7U2A closes and recharges A7C7 through A7R21. Thus, when L SSRQ is pulled, the output of A7U7B will begin to go to zero volts, but may or may not reach zero volts depending on the length of time L SSRQ is pulled. When L SSRQ goes high again and the sweep continues, A7U2A opens and A7U7B resumes its voltage follower operation.

-VTUNE is also applied to differentiator A7C3 and A7U7C. The output is amplified by A7U7B and is applied to the second input of the analog multiplier. The output of TP3 is connected to A7U3 pin 7 to provide feedback for an operational amplifier internal to A7U1. The Z adjust at A7U1 pin 6 allows for nulling of the offset voltage appearing at the output at TP3.

The output of the delay compensation circuit is summed with exponential compensation and sent to the A6 YO driver where it is summed into the main coil driver voltage. Since the delay compensation is unnecessary during CW operation, analog switch A7U2D disables it in that mode by opening the DLY COMP.

FREQUENCY TRACKING AMPLIFIER, BLOCK E

When A7U2B is engaged by the INT LVL control signal, -VTUNE goes through to the input of the inverter amplifier A7U12B. The output of A7U12B is input to emitter-follower amplifier A7Q3 which provides increased current drive capability. This output (called FREQ TRK V) is used in the A4 ALC and A5 FM boards where it is used to compensate for frequency-dependent nonlinearities in various elements of the leveling loop.

PULSE MODULATION LOGIC, BLOCK F

This circuit provides the control lines to blank power when necessary. Whenever [L] MOD] is pressed, a mainframe marker requested, or the RF turned off via the HP 83570A front panel pushbutton, A7U13A goes high. L PULSE is pulled low which puts the A4 ALC assembly sample and hold circuit in the hold mode. At the same time, PULSE I/O goes high and, along with A7Q5, provides current to drive the pulse amplifier on the A2A1 pulse assembly.

SUMMING AMPLIFIER, BLOCK G

Exponential and delay compensation are summed and inverted before being sent to the A6 driver assembly and summed into the YO drive voltage.

EXPONENTIAL AMPLIFIER, BLOCK H

The exponential amplifier compensates for the nonlinear response of the YIG magnets by summing the exponential signal and delay compensation with the YO drive voltage on the YO board.

Since current through a transistor is exponentially related to its base-emitter voltage, the desired exponential compensation is achieved by controlling the base-emitter voltage of the output transistor A7Q1B.

The exponential amplifier works by forcing a current through A7R44 which also flows through A7Q1A. The voltage at the base of A7Q1A is set by two cascade voltage dividers composed of A7R38, A7R40 through A7R43, and A7RT1. Since the voltage across the base-emitter junction of A7Q1A remains relatively constant, a change in voltage at this base junction will appear across the base-emitter junction of A7Q1B, causing the collector current of A7Q1B to increase exponentially. The voltage divider A7R38 and R39 determines the amount of $-V$ TUNE applied to the base of A7Q1A.

NOTE: The values of factory select resistors R38 and R40 through R43 are stamped on a label attached to the RF casting. These resistors are supplied with replacement YOs and must be installed on the A7 bias assembly. The new label, indicating the replacement resistor values, should be attached to the RF casting.

If the A7 bias assembly is replaced, the four factory select resistors must be removed from the defective board and reinstalled on the new assembly. The six breakpoint resistors on the A6 YO assembly must be selected.

NOTE: Delay compensation is disabled in CW mode, however, exponential is not. Be sure to remove the A7 assembly when setting the offset and gain adjustments at the A6 YO driver summing junction.

UNLEVELED LOGIC, BLOCK I

The L UNLVL signal is inverted by A7U10C. The inputs of A7U10D are L RTS and UNLVL, making the output of A7U10D low when the instrument is not retracing and a unlevelled power level exists. This output then goes to timer A7U6 which provides a positive pulse with a long enough duration to turn on the UNLEVELED LED on the front panel.

YIG BIAS, BLOCK J

A7R46, A7R47, and A7R48 comprise a voltage divider string which feeds the input to A7U8. If L RFON goes high, A7Q9 shunts the reference voltage and turns off the bias. A7U8 output goes to Darlington pair A7Q7 and A7Q8 to provide enough current for the YIG.

Table 8-16. Connector Pin Descriptions

A7P1					
PIN	SIGNAL	I/O	TO/FROM	BLOCK	
1	L RFM	IN	P2-24	F	
23	L PULSE	OUT	A4P1-41	F	
2	SQ MOD	IN	P2-26	F	
24	PULSE I/O	I/O	A2A1J3-14	F	
3					
25	L INST1	IN	A3P1-8	B	
4	L SSRQ	IN	P2-32	D	
26					
5	L RTS	IN	P2-57	I	
27	+5V	IN	A3P1-6, 7	K	
6	UNLEVELED	OUT	A8J1-10	I	
28	-15V	IN	P2-28	K	
7	+10V	IN	P1-8	K	
29	L UNLVL	IN	A4P1-2	I	
8					
30					
9	BD1	IN	A3P1-9	B	
31	BD0	IN	A3P1-31	B	
10	BD3	IN	A3P1-10	B	
32	BD2	IN	A3P1-32	B	
11	BA1	IN	A3P1-11	B	
33	BA0	IN	A3P1-33	B	
12	BA3	IN	A3P1-12	B	
34	BA2	IN	A3P1-34	B	
13	BD5	IN	A3P1-13	Not Used	
35	BD4	IN	A3P1-35	B	
14	BD7	IN	A3P1-14	Not Used	
36	BD6	IN	A3P1-36	B	
15	GND ANLG			K	
37	GND ANLG			K	
16	+20V	IN	P1-7	K	
38	+15V	IN	P2-29	K	
17	-10V	IN	P1-13	K	
39					
18	+8.0V REF	OUT	A2A1J3-16	C	
40	-VTUNE	OUT	A2A1J3-13	A	
19	DLY/EXP COMP	OUT	A6P1-26	G	
41	FREQ TRK V	OUT	A4P1-25	E	
			A5P1-24		
20	YIG BIAS	OUT	A8E3	J	
42	+VTUNE	OUT	A9J1-3,4	D	
			A2A1J3-15		
21	L RFON	OUT	A2A1J3-10	F	
43					
22	VTUNE RET	IN	P1-A1	A	
44	VTUNE	IN	P1-A1	A	

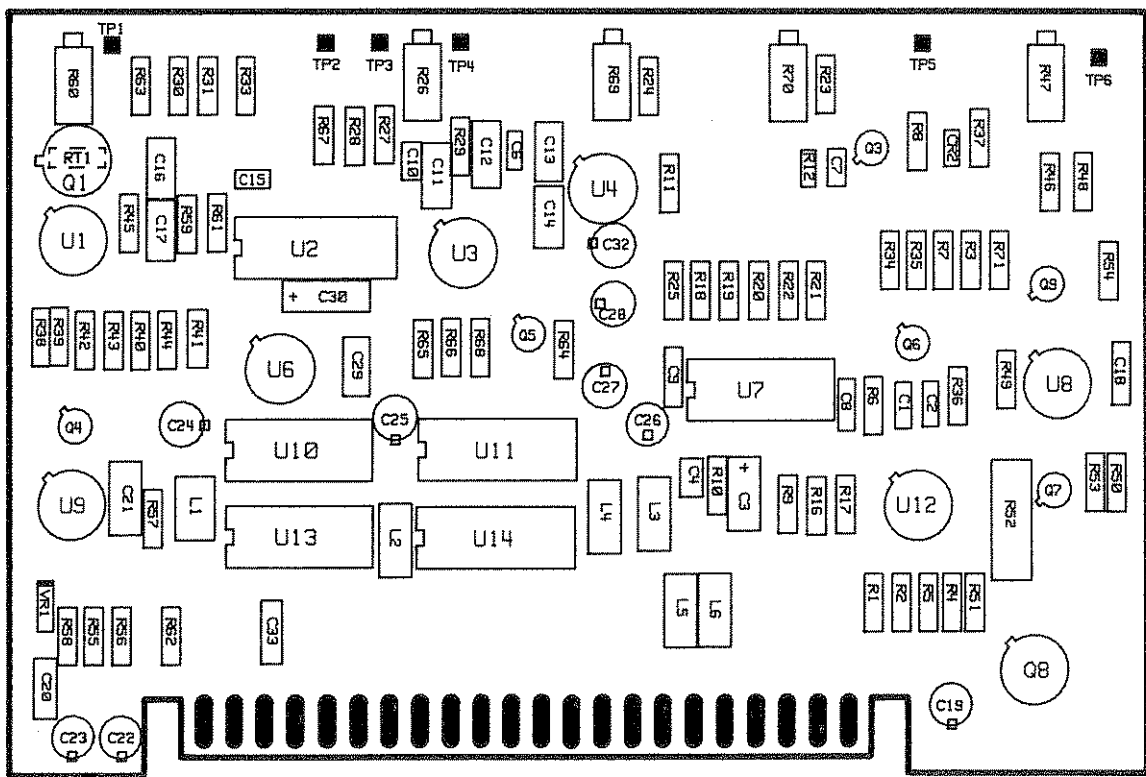
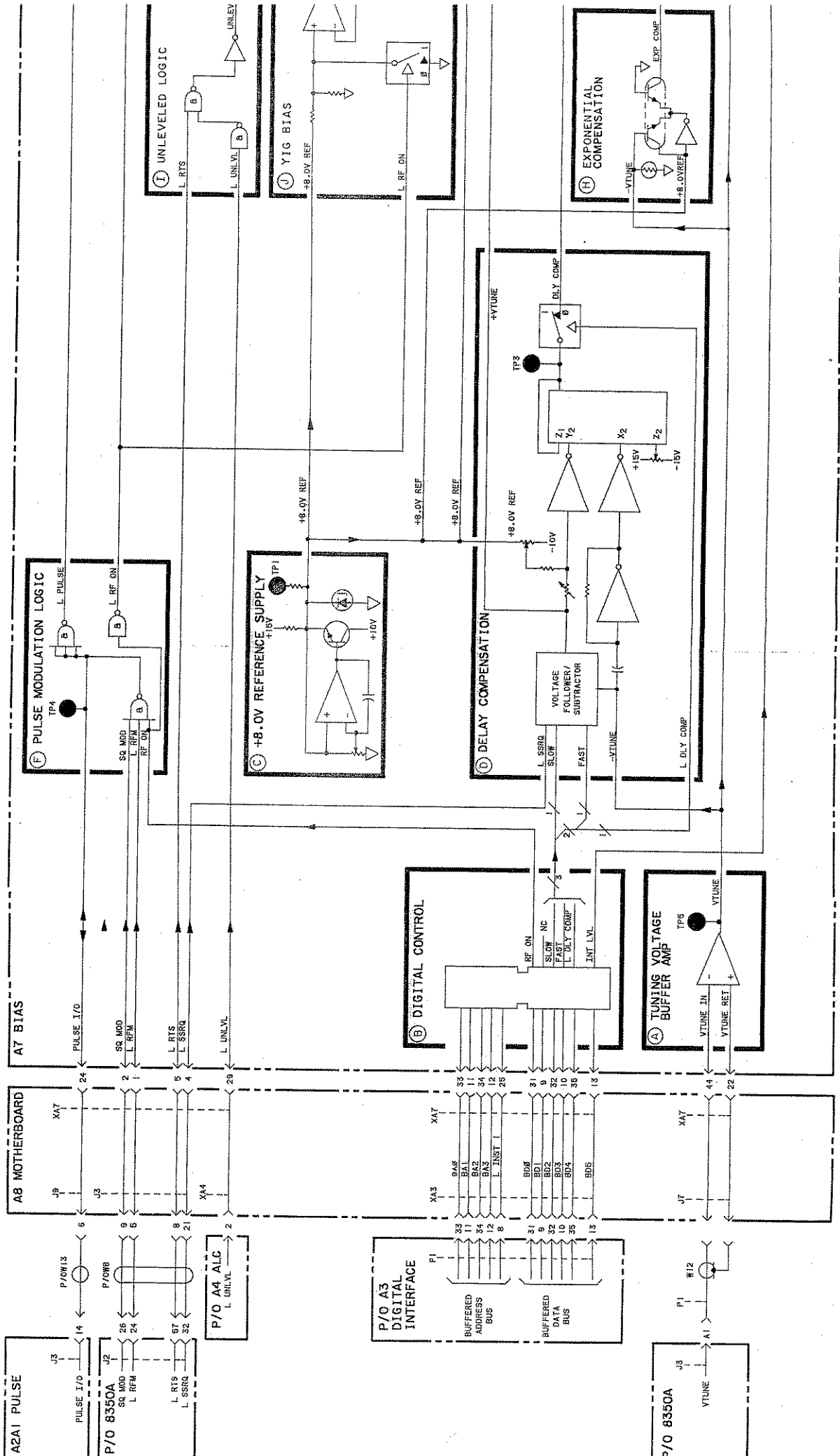

Figure 8-52b. A7 Bias Assembly Component Locations



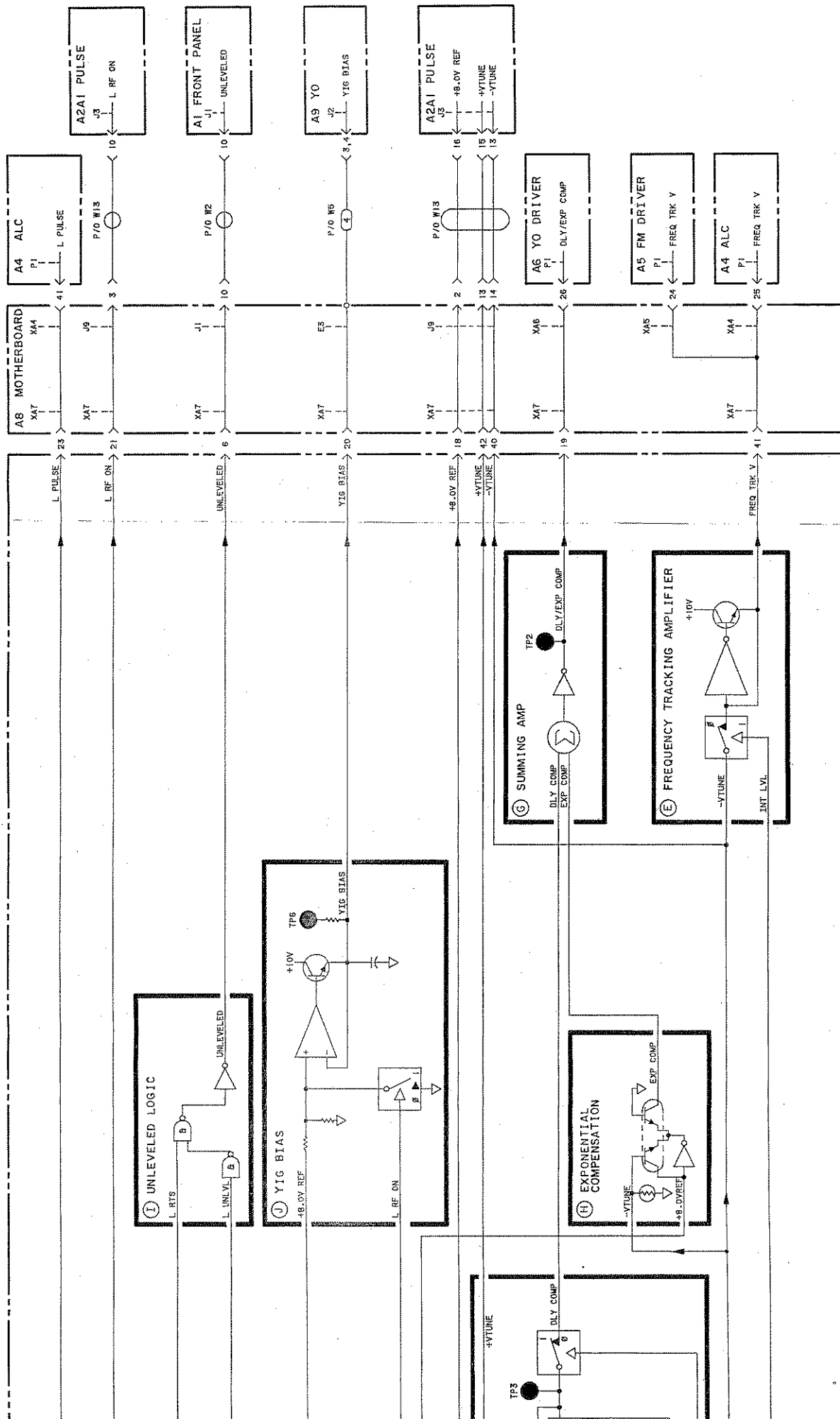
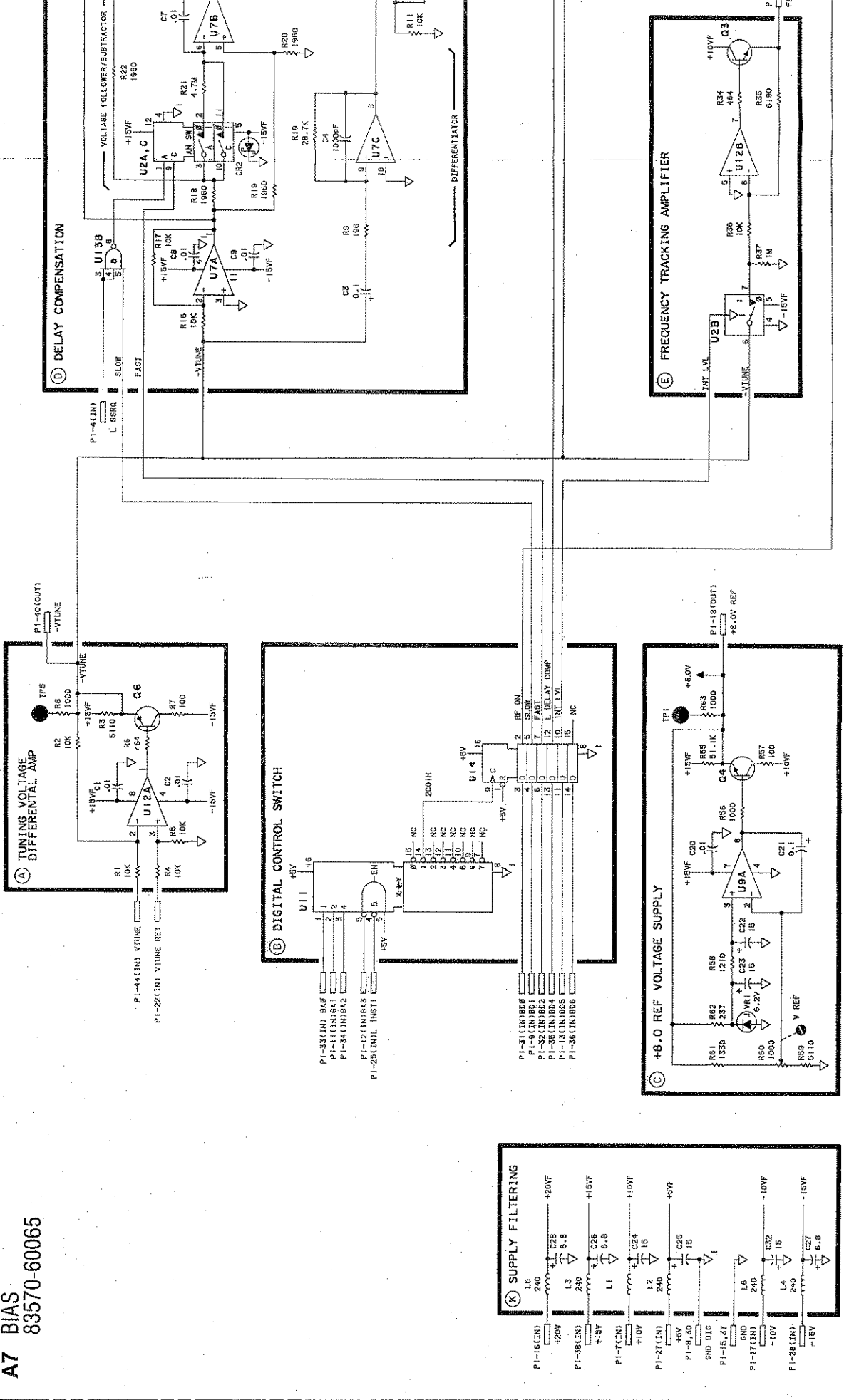
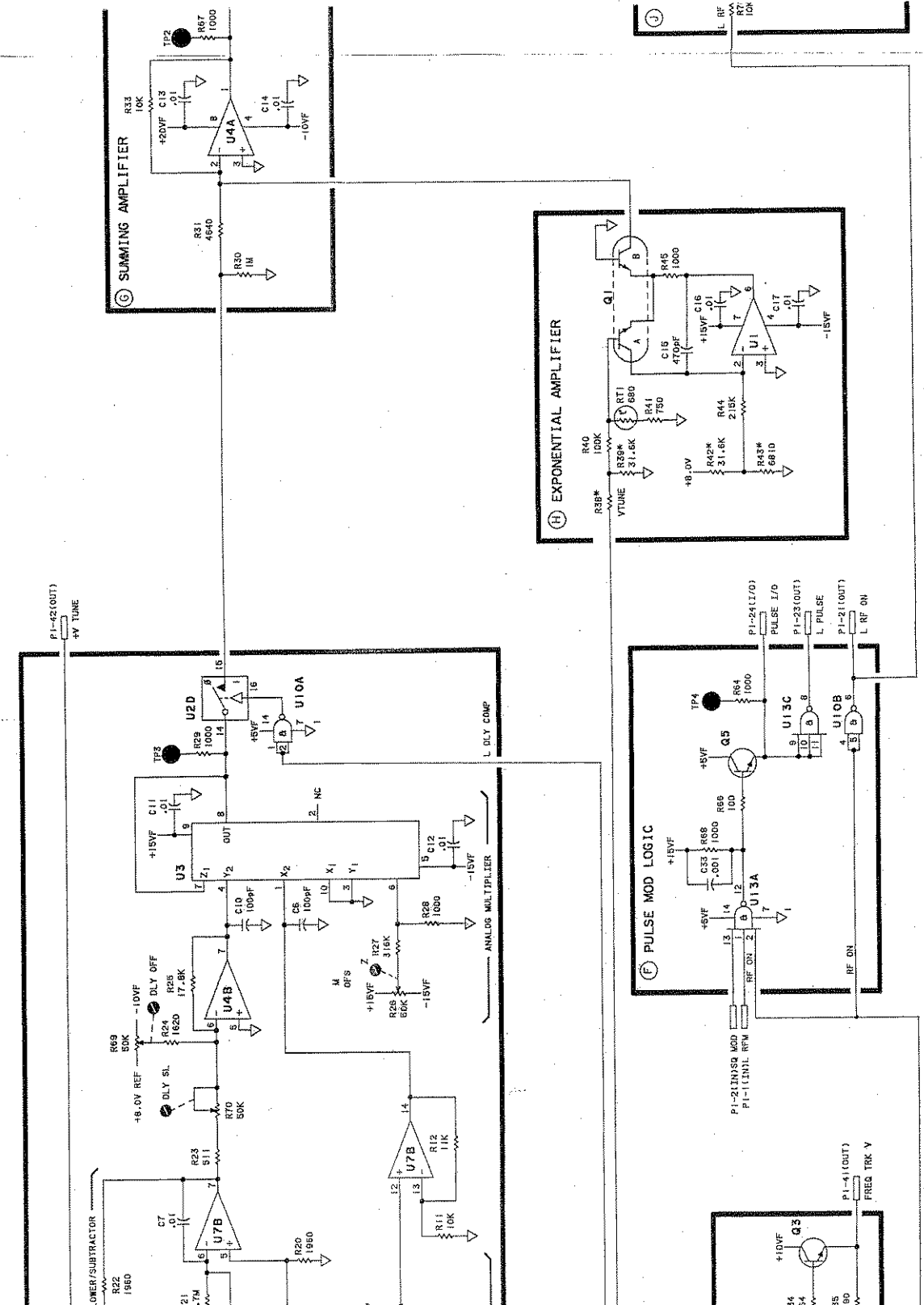

Figure 8-58. A7 Bias Assembly, Overall Block Diagram
8-141/8-142

A7 BIAS
83570-60065





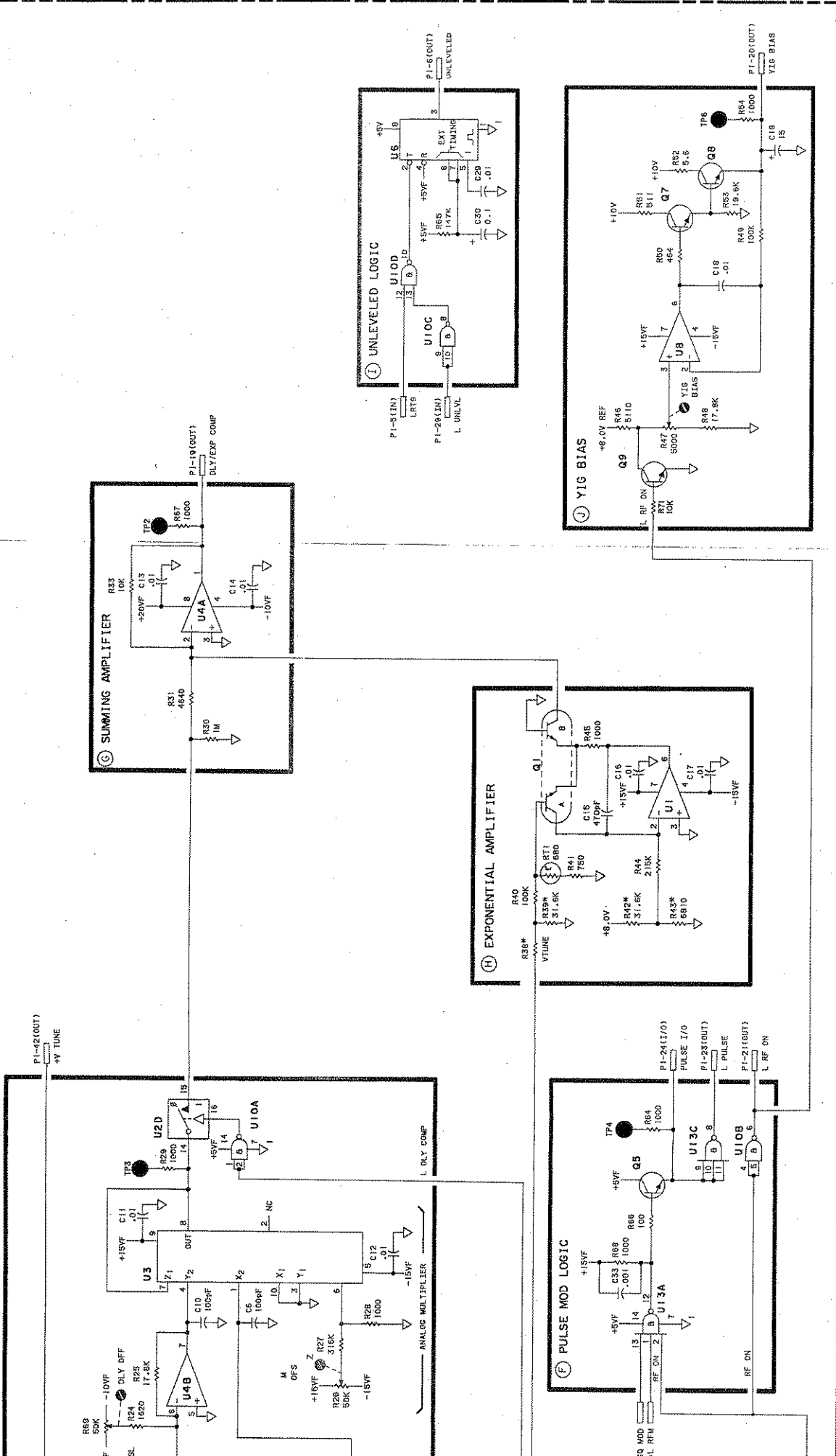

Figure 8-54. A7 Bias Assembly, Schematic Diagram
R-143/R-144

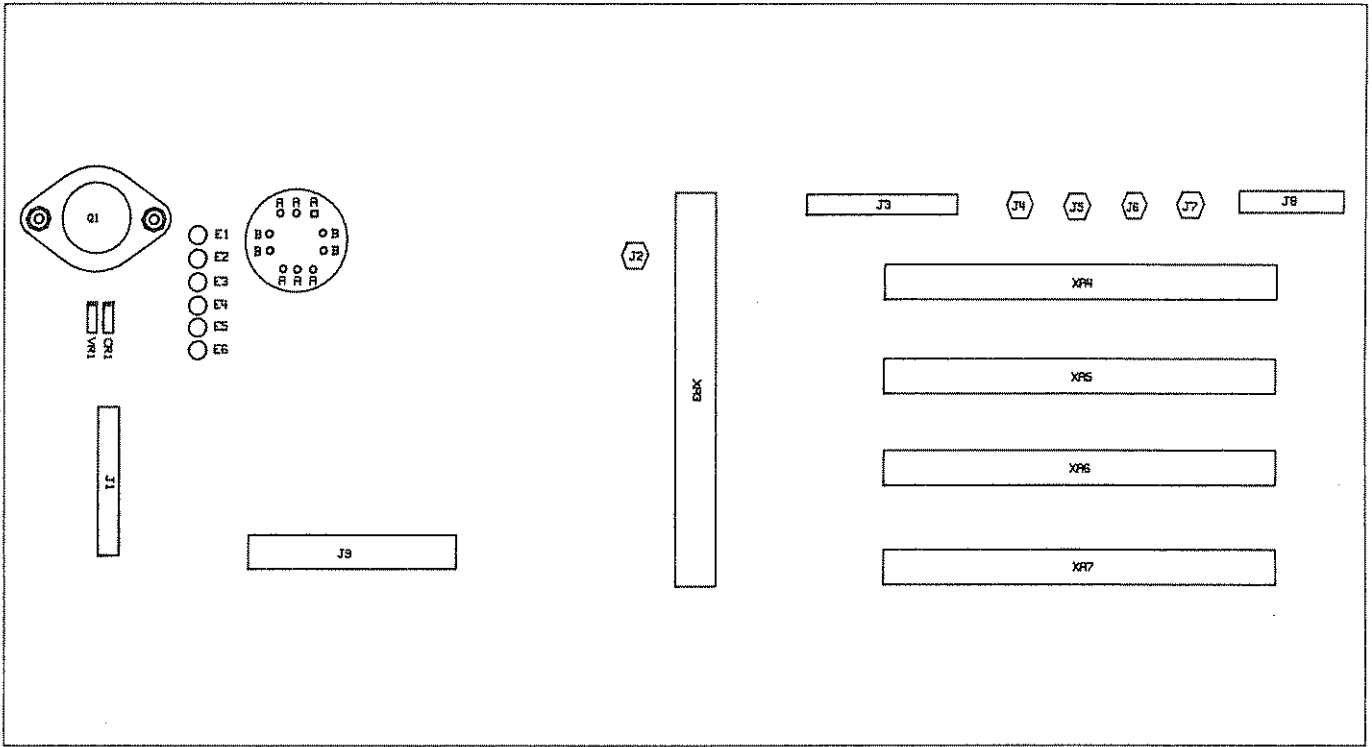

Figure 8-55. Motherboard Component Locations

Table 8-17. 83570A Motherboard Wiring List (1 of 5)

Membrane	Signal Source	Membrane Description	Power Supply Interface P1	Plug in Interface P2	Dig Infc---		AIC	EM	YO	Bias	Doubler Interface		F P Interface	P/O Plug-in Interface AS13	Power Supply Interface AS18	Miscellaneous
					ASP1	AS11					ASP1	ASP1				
AMP	P1-A4	Amplitude Modulation	A4-C1				4									AS25-C1 O1 (Base)
BASE	ASP1-22	YO Current Drive Control						22								
B00	ASP1-33	Buffered Addr 0			33		33	33	33	33						
B01	ASP1-11	Buffered Addr 1			11		11	11	11	11						
B02	ASP1-34	Buffered Addr 2			34		34	34	34	34						
B03	ASP1-12	Buffered Addr 3			12		12	12	12	12						
B04	ASP1-31	Buffered Data 0			31		31	31	31	31						
B05	ASP1-9	Buffered Data 1			9		9	9	9	9						
B06	ASP1-32	Buffered Data 2			32		32	32	32	32						
B07	ASP1-10	Buffered Data 3			10		10	10	10	10						
B08	ASP1-35	Buffered Data 4			35		35	35	35	35						
B09	ASP1-13	Buffered Data 5			13		13	13	13	13						
B10	ASP1-36	Buffered Data 6			36		36	36	36	36						
B11	ASP1-14	Buffered Data 7			14		14	14	14	14						
L BRQ	ASP1-2	L - Blanking Pulse Request (Not Used)														
L CNTR	P2-22	L - Counter Trigger (Not Used)														
COLLECTOR	ABE1	Ref Resistor						41								ABE1 O1 (Collector)
DLY/EXP COMP	AP11-19	YO Delay/Exponential Compensation						26		19						
EMITTER/COIL	AGE5	YO Coil Current						20								
EXT CAL	AS11-12	External Leveling Power Cal			24		24									
EXT DET	J2(BNC)	External Leveling Input			23		23									
EXT DET RET	J2(BNC)	External Leveling Return			1		1									
FLAG	AB11-25	Front Panel Flag			42			40								
FM IN	P1-43	Frequency Modulation Input	A3-C1					39,41								
FM IN RET	P1-43	Frequency Modulation Return	AS-SP													

- Coxial Cable - Center conductor
- Coxial Cable - Shield
- Not used on this assembly

Table 6-17. 83570A Motherboard Wiring List (2 of 5)

Mnemonic	Signal Source	Mnemonic Description	Power Supply Interface P1	Plug-in Interface P2	Dig Inlet		NIC ADP1	FM ASFP1	YO RBP1	Bios ATP1	Doubler Interface		F.P. Interface ASJ1	P/O Plug-in Interface ASJ3	Power Supply Interface ASJ8	Miscellaneous
					ASP1	ASJ1					Pulse ASJ1J3	ASJ8				
LFP1	A3P1-15	L = F.P. Display Write		15												
LFP2	A3P1-37	L = F.P. Keyboard Read		37												
LFP3	A3P1-16	L = F.P. Annunciator Write		16												
LFP4	A3P1-28	L = F.P. Annunciator Write		28												
LFP5	A3P1-30	L = F.P. RF Control (Not Used)		30												
FRQ TRK V	A7P1-41	Frequency Tracking Voltage					25	24	41							
HFREQ FM	ASP1-21	YO FM Coil Drive						21								ABJA-C, ASJ1-2
HFREQ FM RET	ASP1-20/22	YO FM Coil Return						20/22								ABJA-S, ASJ1-1
L1A0	P2-38	Inst Bus - Inv Addr 0		38												
L1A1	P2-7	Inst Bus - Inv Addr 1		7												
L1A2	P2-39	Inst Bus - Inv Addr 2		39												
L1A3	P2-8	Inst Bus - Inv Addr 3		8												
L1A4	P2-40	Inst Bus - Inv Addr 4		40												
L1A5	P2-41	Inst Bus - Inv Addr 5		41												
L1A6	P2-10	Inst Bus - Inv Addr 6		10												
L1A7	P2-42	Inst Bus - Inv Addr 7		42												
L1A8	P2-11	Inst Bus - Inv Addr 8		11												
L1A9	P2-43	Inst Bus - Inv Addr 9		43												
L1A10	P2-12	Inst Bus - Inv Addr 10		12												
L1A11	P2-44	Inst Bus - Inv Addr 11		44												
L1A12	P2-13	Inst Bus - Inv Addr 12		13												
I00	P2-33	Inst Bus - Data 0		33												
I01	P2-2	Inst Bus - Data 1		2												
I02	P2-34	Inst Bus - Data 2		34												
I03	P2-3	Inst Bus - Data 3		3												
I04	P2-35	Inst Bus - Data 4		35												
I05	P2-4	Inst Bus - Data 5		4												
I06	P2-36	Inst Bus - Data 6		36												
I07	P2-5	Inst Bus - Data 7		5												

1. Coaxial Cable - Center conductor
2. Coaxial Cable - Shield
3. Not used on this assembly

Table 8-17. 83570A Motherboard Wiring List (3 of 5)

Miscellaneous	Signal Source	Miscellaneous Description	Power Supply Interface P1	Plug-in Interface P2	—Dig Inits—		ALC A3J1	FM ABP1	YD ABP1	Bias ATP1	Doubler Interface		P/O Plug-in Interface ASJ3	Power Supply Interface ASJ8	Miscellaneous
					A3P1	A3J1					Pulse AZA1J3	ABJ9			
L INST1	ASPI-8	L=Plug-in Control			8	29	10	5	18	25					
L INST2	ASPI-29	L=Plug-in Control													
INT DET	AZA1J3-11	Internal RF Detector					20				11				
INT DET RET	AZA1J3-18	Internal RF Detector Return					42				18				
I/O E2	PZ-47	Plug-in I/O Enable		47										AZAJ26	
I/O STB	PZ-17	Inv I/O Strobe		17										Chassis Ground	
L IRO	PZ-15	L=Inst Bus Read		15											
LQ FREQ FM	ASPI-2	Low Freq FM (Main Cop)						2	25						
MOD DRIVE	ASPI-22	Modulator Drive					22				2				
L RFLG	A3A1J1-38	L=Plug-in Flag		20			39								
L RIRQ	A3A1J1-46	L=Plug-in Interrupt Request		52			40								
L PINMI	(NC)	L=Plug-in Non-Maskable Interrupt		19			26								
PRDOME	PZ-45	Plug-in ROM Enable		45											
SRPGA	ASPI-6	Plug-in REG A		60											
PRPGB	ASPI-8	Plug-in REG B		61											
PULSE IN	J1(BNC)	External Pulse Input													
PULSE I/O	ATP1-24	Pulse Input/Output					41			24	14				
L PULSE	ATP1-23	L=RF Pulse Mod							15	23					
PAWON	PZ-25	Power On		25						3*					
PWR REF	ASPI-3	Power Level Reference (Not Used)													
PWR SW/COMP	ASPI-23	Power Sleep Level Compensation					5		23						
L RFB8	PZ-56	L=RF Banking		56			29								
L RFR80	ADP1-24	L=RF Banking Request (Not Used)													
L RFBM	PZ-24	L=RF Marker		24						1					
L RFBON	ATP1-21	L=RF On								21	10				
L RT5	PZ-57	L=Retrace Strobe		57					1	5					

- Coaxial Cable - Center conductor
- Coaxial Cable - Shield
- Not used on this assembly

Table 8-17. 83570A Motherboard Wiring List (4 of 5)

Memoric	Signal Source	Memoric Description	Power Supply Interface P1	Plug-in Interface P2	---Dig Inits---		A/C	FM	YD	Bias	Inhibitor Interface		P/O Plug-in Interface A&B	Power Supply Interface A&B	Miscellaneous
					A3P1	A3I1					A3J1	A3K1			
SCAN CLK	A3P1-38	F.P. Scan Clock				38									
L SIRQ	ABP1-3	L = Sweep Interrupt Request				15									
SOMOD	P2-26	Square Modulation (27.8, 1.0 kHz)		26											
L SSWO	P2-32	L = Stop Sweep Request													
UNLEVELD	API-6	Unlevelled LED on													
L UNLVX	API-2	L = Unlevelled													
VSW	P2-64	Sweep Voltage													
VTUNE	PI-A1	Tune Voltage													
VTUNE RET	PI-A1	Tune Voltage Return	A1-C1 A1-S1												
-VTUNE	API-40	Inverted Tuning Voltage													
+VTUNE	API-42	Standard Tuning Voltage													
VIG BIAS	API-20	VIG Oscillator Bias													
-10V REF	ABP1-5	-10V Reference Voltage													
+8.0V REF	ATP1-18	+8.0V Reference Voltage													
+20V FREQ REF	ABE2	+20V Frequency Reference Sense													

1. Coaxial Cable - Center conductor
 2. Coaxial Cable - Shield
- Not used on this assembly

Table 8-17. 83570A Motherboard Wiring List (5 of 5)

Miscant	Signal Source	Memoric Description	Power Supply Interface P1	Plug-in Interface P2	Dig Infr---		ALC MAP1	FM ASP1	YO ASP1	Bis ATP1	Dabler Interface		F.P. Interface ABJ1	P/O Plug-in Interface ASJ3	Power Supply Interface ASJB	Miscellaneous
					A3P1	A3J1					Pulse A2A L3	ABJ9				
+20V	P1-7	+20V Regulated	7				16"	16	15						4	ABE2, RI, N2
+20V RET	P1-14	+20V Return	14					19							1	
+20V RET SENSE	P1-8	+20V Return Sense	5					19							10	
+20V SENSE	P1-15	+20V Sense	15												13	ABE2
+15V	P2-29	+15V Regulated		29			38	38	38	38	9	19	15		16	
+10V	P1-8	+10V Regulated	8				7	7	7	7	1	5,17	14		3,12	
+10V RET	P1-3	+10V Return	3													
+5V	ASP1-6,7	+5V Internal for RF Plug-In					27	27	27	27			2			
+5VA	P2-30	+5V for 8350A		30												
+5VB	P2-18,50,51	+5V for RF Plug-In		18,50,51			35,36,36							20*		
+5V UNREG	PW-82,83	+5V Unregulated (Not Used)		63												
-10V	P1-13	-10V Regulated	13				17	17	17	17	12	4,16	16		6	
-10V RET SENSE	P1-12	-10V Return Sense	12												2	
-10V SENSE	P1-4	-10V Sense	4												5	
-10V UNREG	P1-5	-10V Unregulated (Not Used)	5													
-15V	P2-28	-15V Regulated		28			28	28	28	28	17	20	13			
-40V	P1-11	-40V Regulated	11				6,39	6,39	6,39	6,39					18	ABE4, ABCR1
-40V RET	P1-1	-40V Return	1												8	
-40V RET SENSE	P1-10	-40V Return Sense	10												9	
-40V SENSE	P1-2	-40V Sense	2												17	ABE4
GND ANLG	P2-56,59	Analog Ground					15,37	15, 37, 20, 22	19,37	15,37				10,12		ABE5, ABJ5-S2
GND DIG	P2-18,14, 16,21,31, 46,48,49	Digital Ground		58,59, 15,4,14, 16,21,31, 46,48,49			8,30	8,30	8,30	8,30			25			

- Covered Cable - Center conductor
- Covered Cable - Shield
- Not used on this assembly

FRONT VIEW

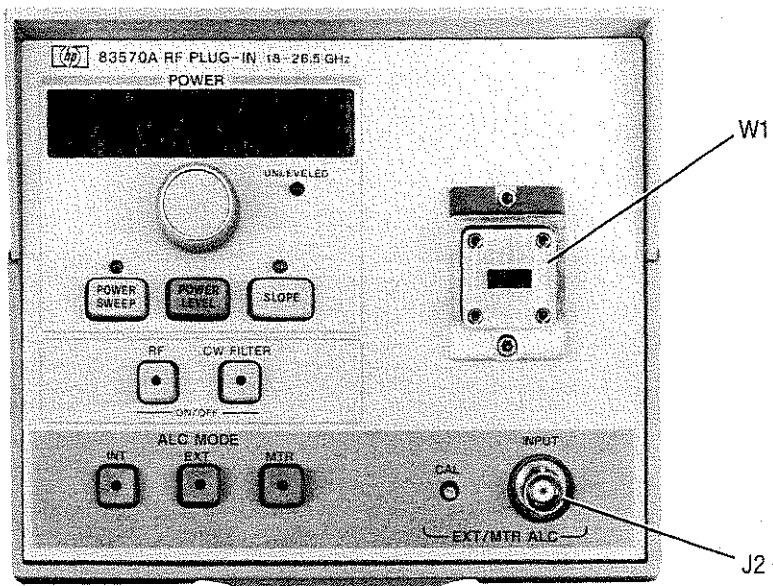

REAR VIEW

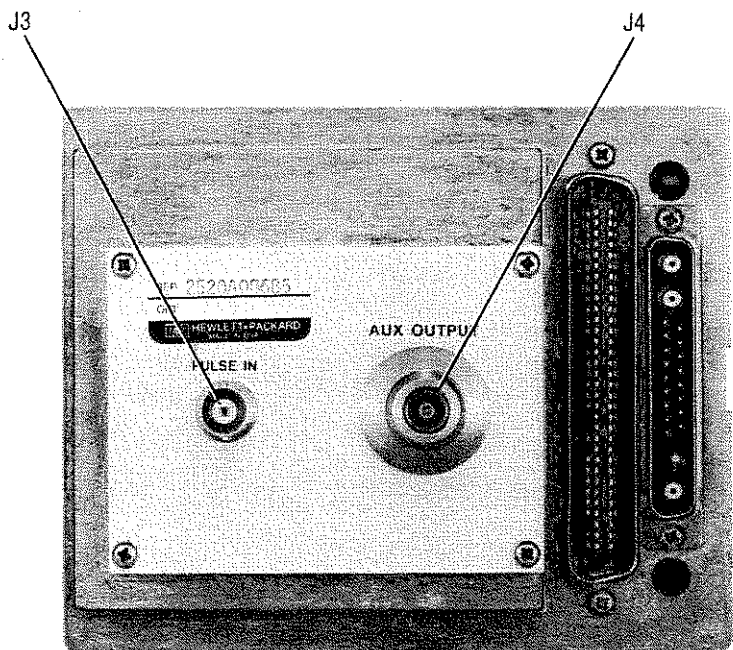

Figure 8-56. Major Assembly Locations (1 of 3)

TOP VIEW

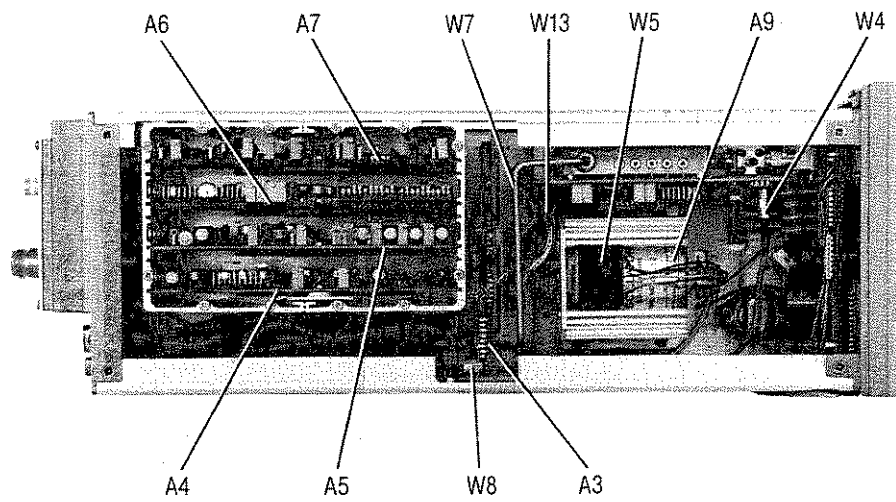

Figure 8-56. Major Assembly Locations (3 of 3)

